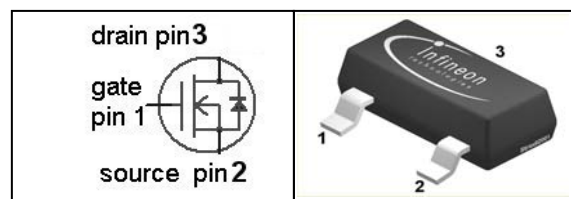

SIPMOS® Small-Signal-Transistor
Features

- N-channel
- Depletion mode
- dv/dt rated

Product Summary

V_{DS}	60	V
$R_{DS(on),max}$	8	Ω
$I_{DSS,min}$	0.13	A

SOT-23

Type	Package	Ordering Code	Tape and Reel Information	Marking
BSS159N	SOT-23	Q67042-S1488	E6327: 3000 pcs/reel	SGs

Maximum ratings, at $T_j=25\text{ °C}$, unless otherwise specified

Parameter	Symbol	Conditions	Value	Unit
Continuous drain current	I_D	$T_A=25\text{ °C}$	0.23	A
		$T_A=70\text{ °C}$	0.18	
Pulsed drain current	$I_{D,pulse}$	$T_A=25\text{ °C}$	0.92	
Reverse diode dv/dt	dv/dt	$I_D=0.23\text{ A}$, $V_{DS}=60\text{ V}$, $di/dt=200\text{ A}/\mu\text{s}$, $T_{j,max}=150\text{ °C}$	6	kV/ μs
Gate source voltage	V_{GS}		± 20	V
ESD sensitivity (HBM) as per MIL-STD 883			Class 1	
Power dissipation	P_{tot}	$T_A=25\text{ °C}$	0.36	W
Operating and storage temperature	T_j, T_{stg}		-55 ... 150	$^{\circ}\text{C}$
IEC climatic category; DIN IEC 68-1			55/150/56	

Parameter	Symbol	Conditions	Values			Unit
			min.	typ.	max.	

Thermal characteristics

Thermal resistance, junction - minimal footprint	R_{thJA}		-	-	350	K/W
--	------------	--	---	---	-----	-----

Electrical characteristics, at $T_j=25\text{ }^\circ\text{C}$, unless otherwise specified
Static characteristics

Drain-source breakdown voltage	$V_{(BR)DSS}$	$V_{GS}=-10\text{ V}, I_D=250\text{ }\mu\text{A}$	60	-	-	V
Gate threshold voltage	$V_{GS(th)}$	$V_{DS}=3\text{ V}, I_D=26\text{ }\mu\text{A}$	-3.5	-2.8	-2.4	
Drain-source leakage current	$I_{D(off)}$	$V_{DS}=60\text{ V}, V_{GS}=-10\text{ V}, T_j=25\text{ }^\circ\text{C}$	-	-	0.1	μA
		$V_{DS}=60\text{ V}, V_{GS}=-10\text{ V}, T_j=125\text{ }^\circ\text{C}$	-	-	10	
Gate-source leakage current	I_{GSS}	$V_{GS}=20\text{ V}, V_{DS}=0\text{ V}$	-	-	10	nA
Saturated drain current	I_{DSS}	$V_{GS}=0\text{ V}, V_{DS}=10\text{ V}$	130	-	-	mA
Drain-source on-state resistance	$R_{DS(on)}$	$V_{GS}=0\text{ V}, I_D=0.07\text{ A}$	-	3.9	8	Ω
		$V_{GS}=10\text{ V}, I_D=0.23\text{ A}$	-	1.8	3.5	
Transconductance	g_{fs}	$ V_{DS} >2 I_D R_{DS(on)max}, I_D=0.16\text{ A}$	0.1	0.19	-	S

Parameter	Symbol	Conditions	Values			Unit
			min.	typ.	max.	

Dynamic characteristics

Input capacitance	C_{iss}	$V_{GS}=-10\text{ V}, V_{DS}=25\text{ V},$ $f=1\text{ MHz}$	-	33	44	pF
Output capacitance	C_{oss}		-	8.3	11	
Reverse transfer capacitance	C_{rss}		-	3.9	5.9	
Turn-on delay time	$t_{d(on)}$	$V_{DD}=25\text{ V},$ $V_{GS}=-3\dots 7\text{ V},$ $I_D=0.16\text{ A}, R_G=6\ \Omega$	-	3.1	4.7	ns
Rise time	t_r		-	2.9	4.4	
Turn-off delay time	$t_{d(off)}$		-	9	13	
Fall time	t_f		-	9	13	

Gate Charge Characteristics

Gate to source charge	Q_{gs}	$V_{DD}=40\text{ V}, I_D=0.16\text{ A},$ $V_{GS}=-3\text{ to }5\text{ V}$	-	0.14	0.21	nC
Gate to drain charge	Q_{gd}		-	0.7	1.1	
Gate charge total	Q_g		-	2.2	2.9	
Gate plateau voltage	$V_{plateau}$		-	-0.14	-	V

Reverse Diode

Diode continuous forward current	I_S	$T_A=25\text{ }^\circ\text{C}$	-	-	0.23	A
Diode pulse current	$I_{S,pulse}$		-	-	0.92	
Diode forward voltage	V_{SD}	$V_{GS}=-10\text{ V}, I_F=0.23\text{ A},$ $T_J=25\text{ }^\circ\text{C}$	-	0.81	1.2	V
Reverse recovery time	t_{rr}	$V_R=30\text{ V}, I_F=0.16\text{ A},$ $di_F/dt=100\text{ A}/\mu\text{s}$	-	10.4	13	ns
Reverse recovery charge	Q_{rr}		-	3.3	4.1	nC

1 Power dissipation

$P_{tot}=f(T_A)$

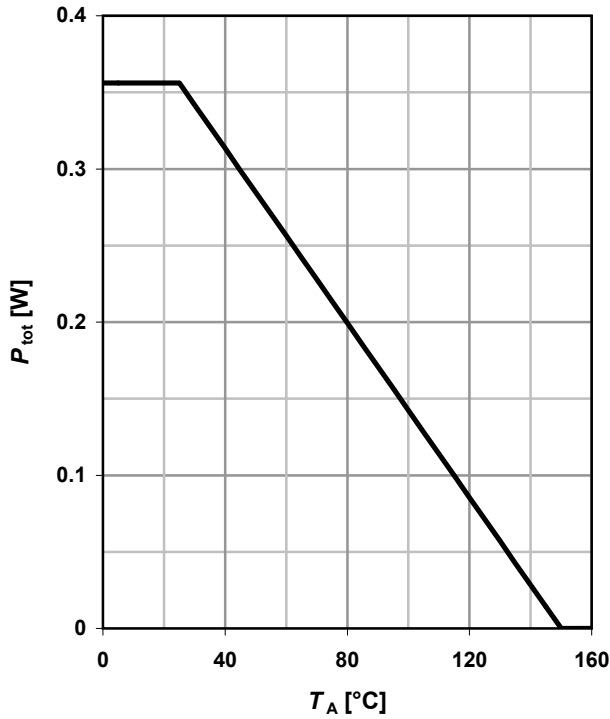

2 Drain current

$I_D=f(T_A); V_{GS} \geq 10\text{ V}$

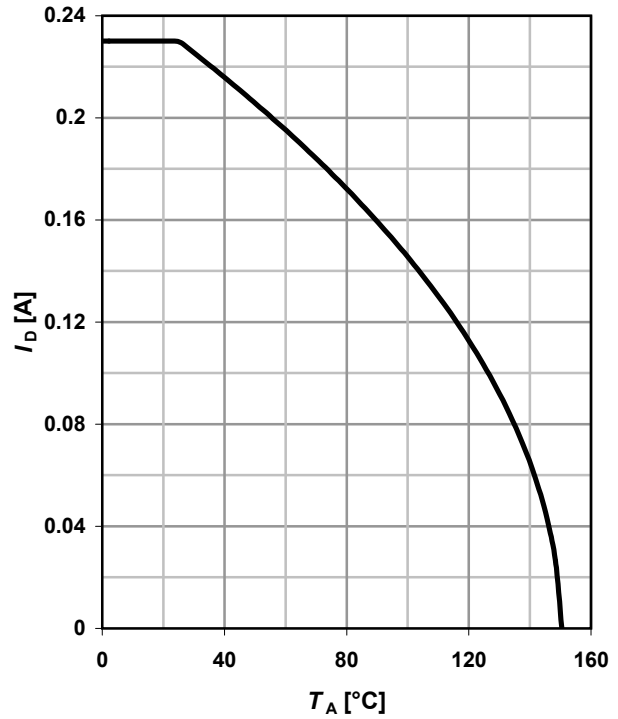

3 Safe operation area

$I_D=f(V_{DS}); T_A=25\text{ °C}; D=0$

parameter: t_p

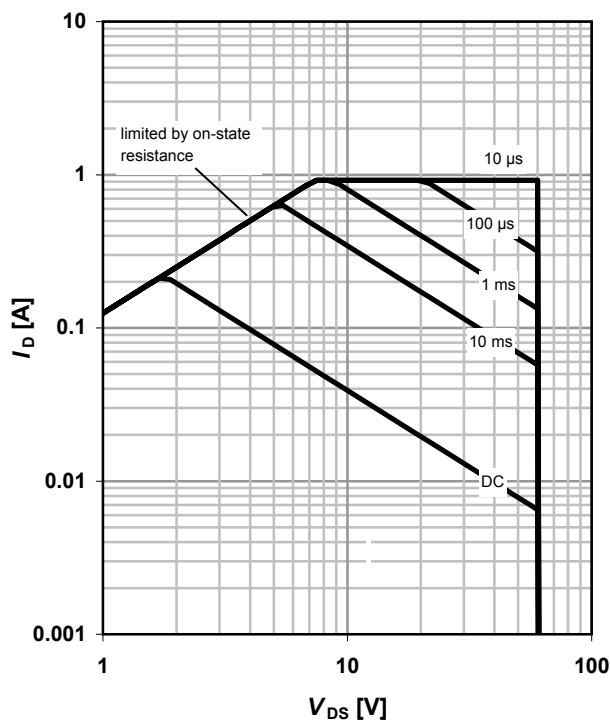

4 Max. transient thermal impedance

$Z_{thJA}=f(t_p)$

parameter: $D=t_p/T$

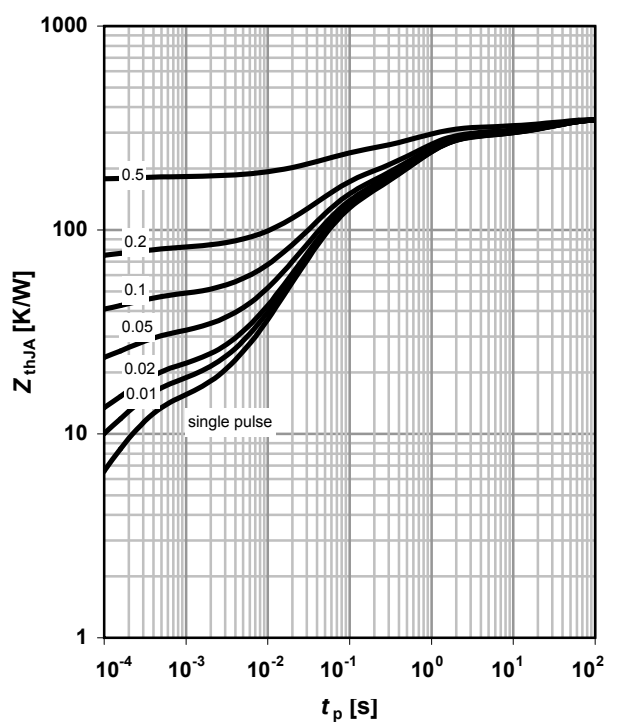

5 Typ. output characteristics

$I_D = f(V_{DS}); T_j = 25\text{ }^\circ\text{C}$

parameter: V_{GS}

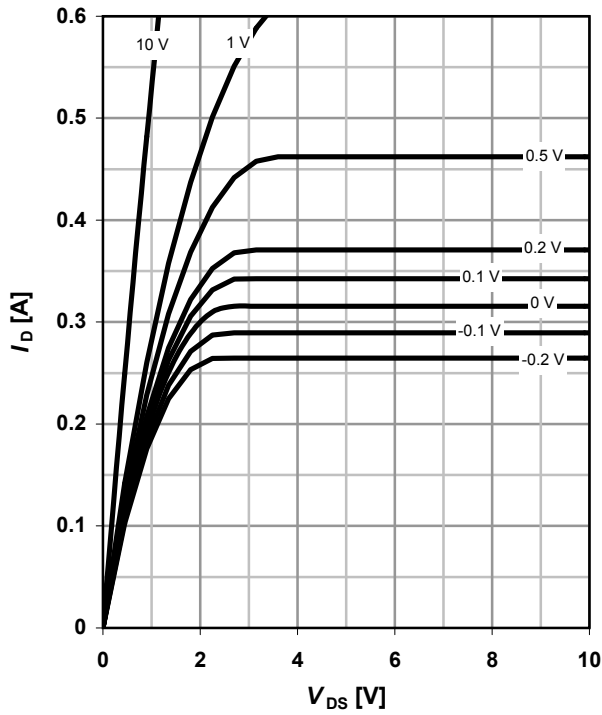

6 Typ. drain-source on resistance

$R_{DS(on)} = f(I_D); T_j = 25\text{ }^\circ\text{C}$

parameter: V_{GS}

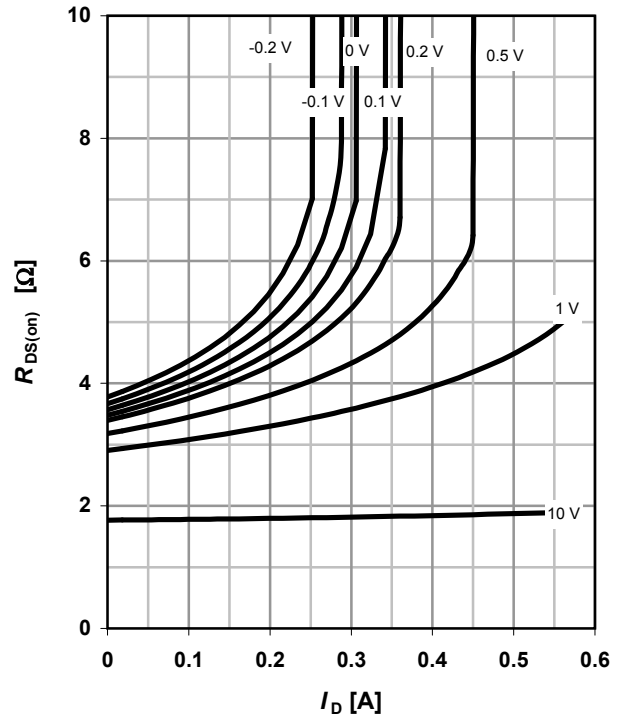

7 Typ. transfer characteristics

$I_D = f(V_{GS}); |V_{DS}| > 2|I_D|R_{DS(on)max}$

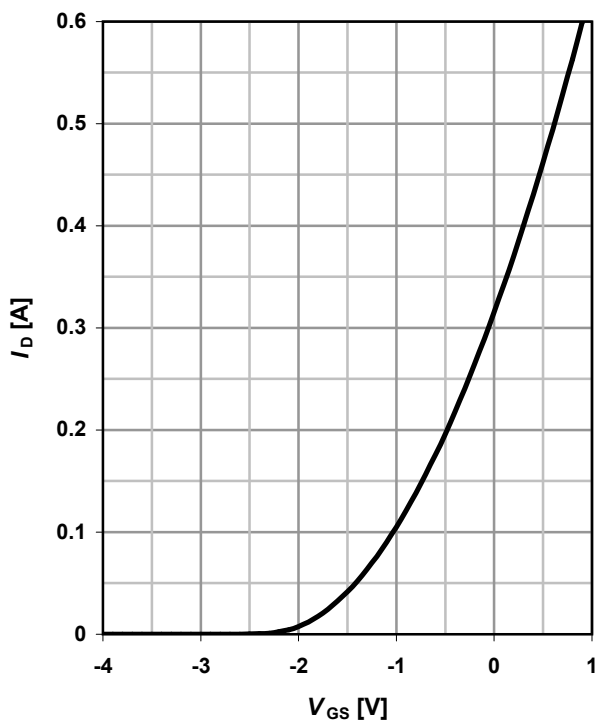

8 Typ. forward transconductance

$g_{fs} = f(I_D); T_j = 25\text{ }^\circ\text{C}$

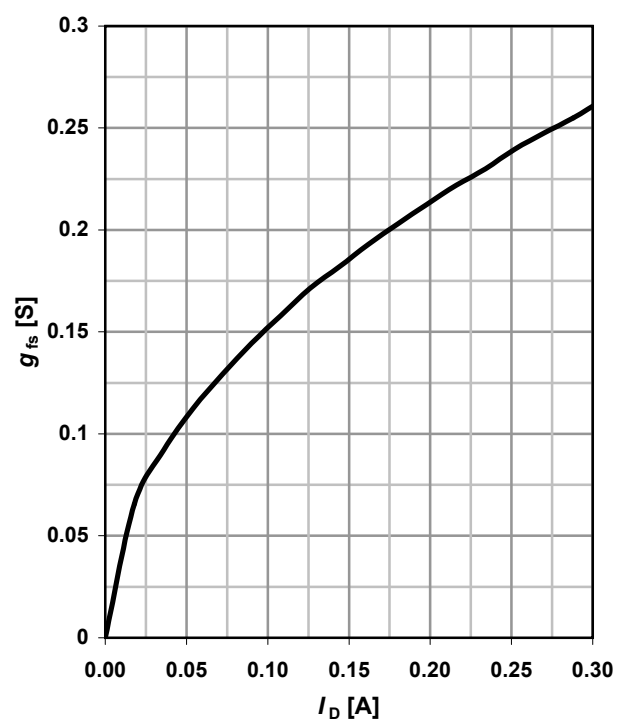

9 Drain-source on-state resistance

$R_{DS(on)} = f(T_j); I_D = 0.07 \text{ A}; V_{GS} = 0 \text{ V}$

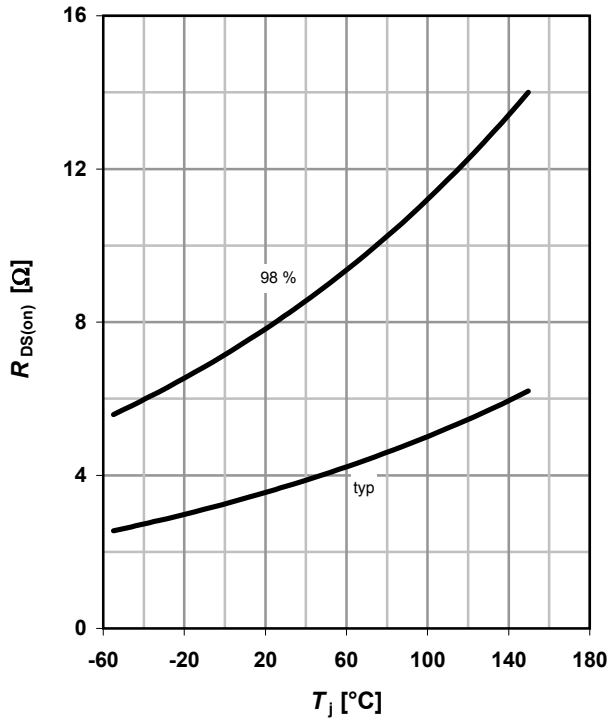

10 Typ. gate threshold voltage

$V_{GS(th)} = f(T_j); V_{DS} = 3 \text{ V}; I_D = 26 \mu\text{A}$

parameter: I_D

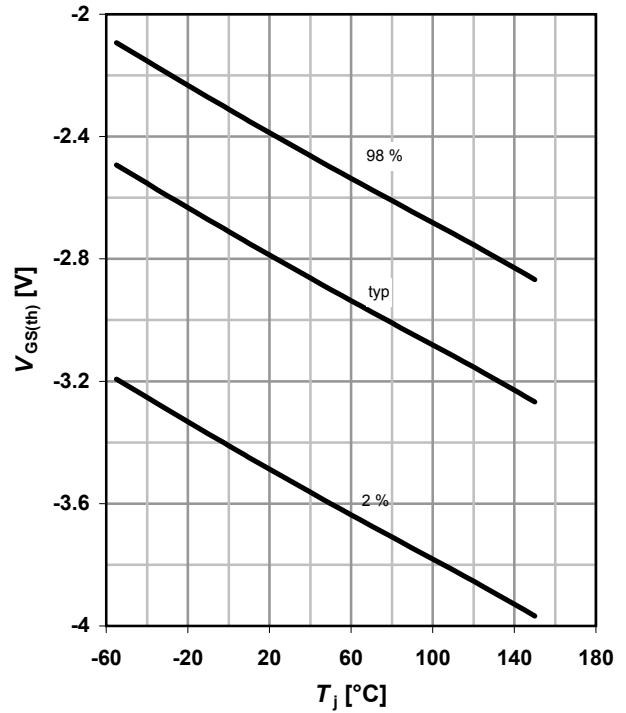

11 Typ. Capacitances

$C = f(V_{DS}); V_{GS} = -10 \text{ V}; f = 1 \text{ MHz}$

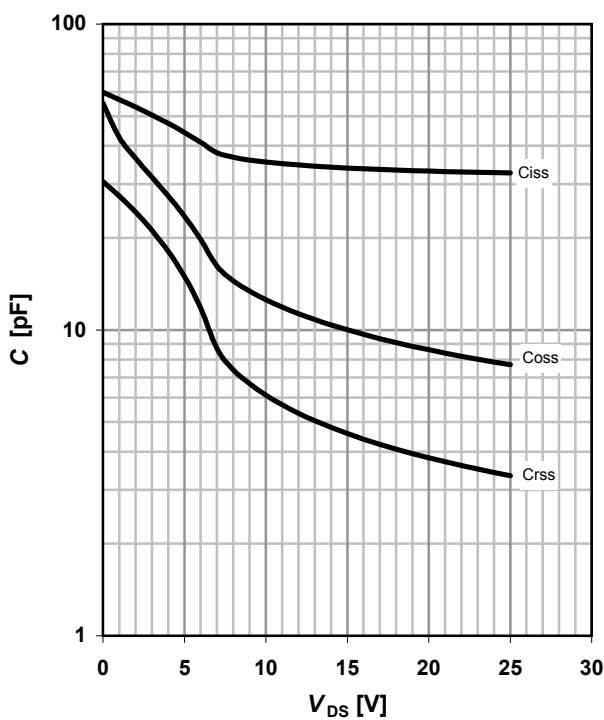

12 Forward characteristics of reverse diode

$I_F = f(V_{SD})$

parameter: T_j

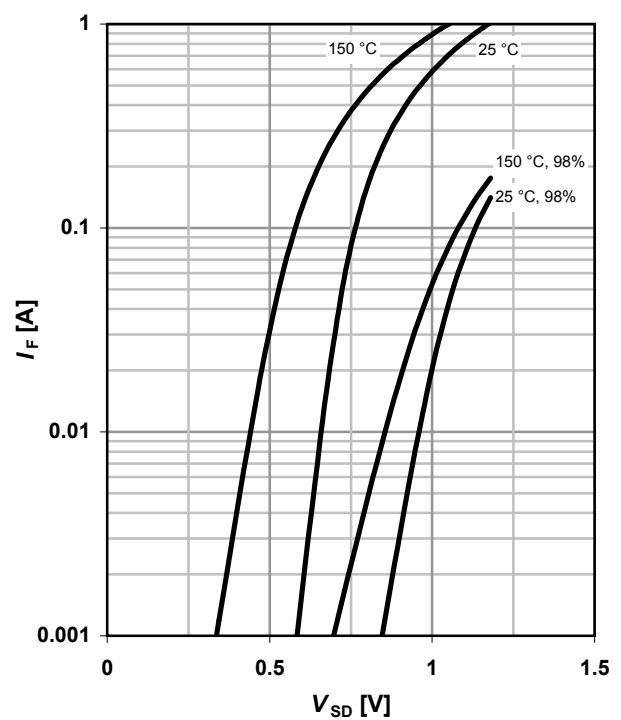

14 Typ. gate charge

$V_{GS}=f(Q_{gate}); I_D=0.16\text{ A pulsed}$

parameter: V_{DD}

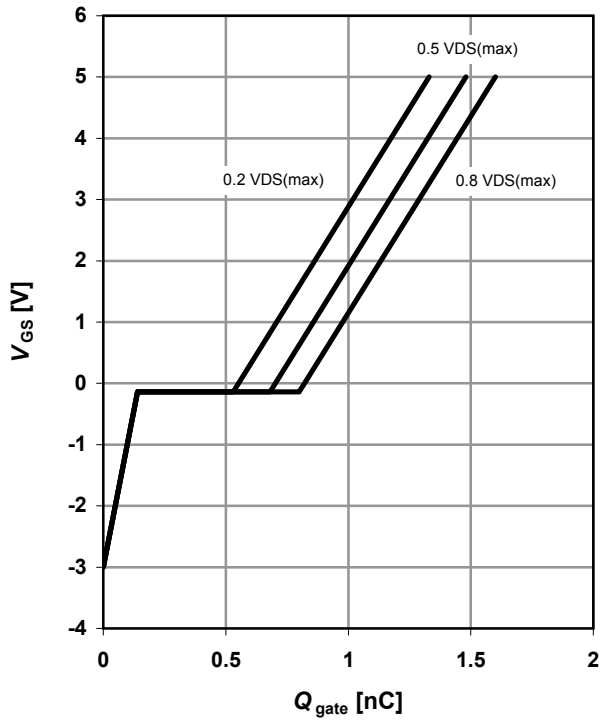

15 Drain-source breakdown voltage

$V_{BR(DSS)}=f(T_j); I_D=250\text{ }\mu\text{A}$

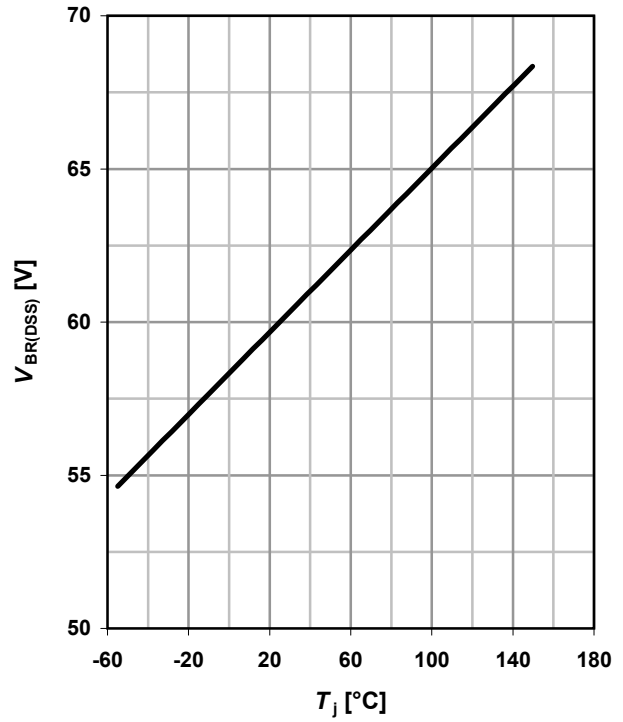

Package Outline:

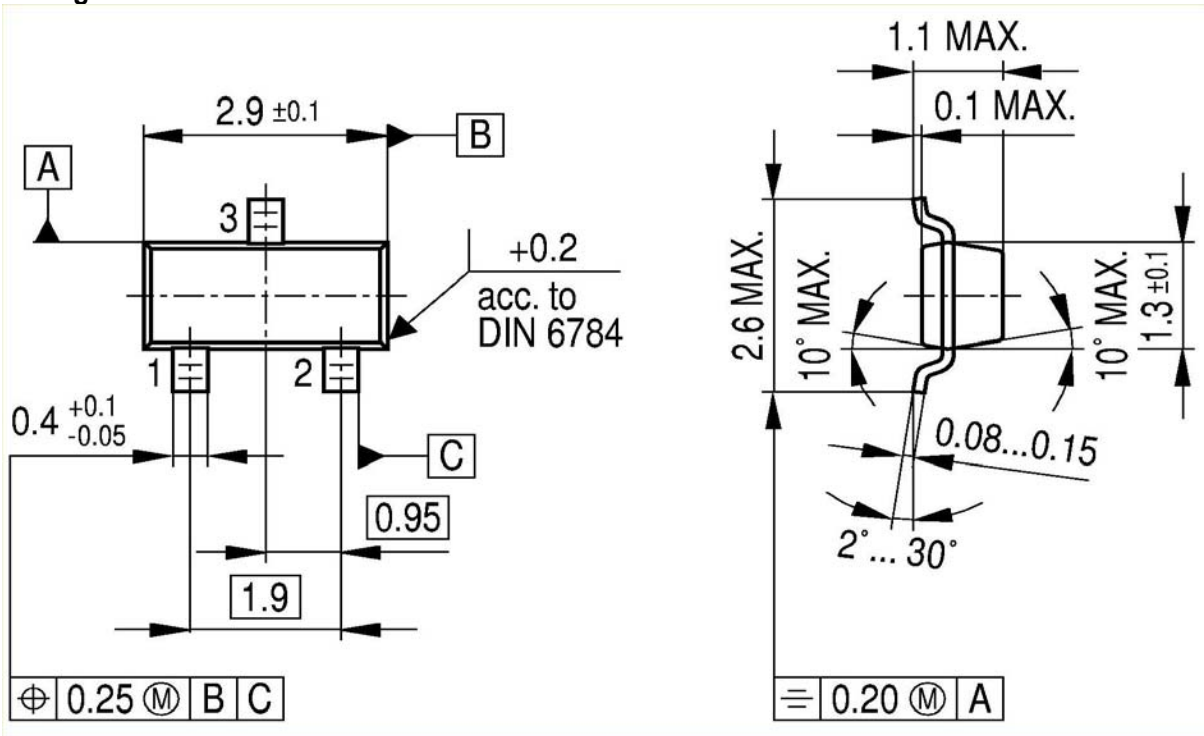

Footprint:

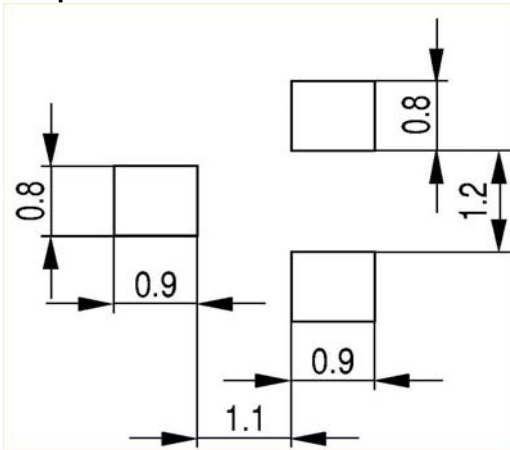

Packaging:

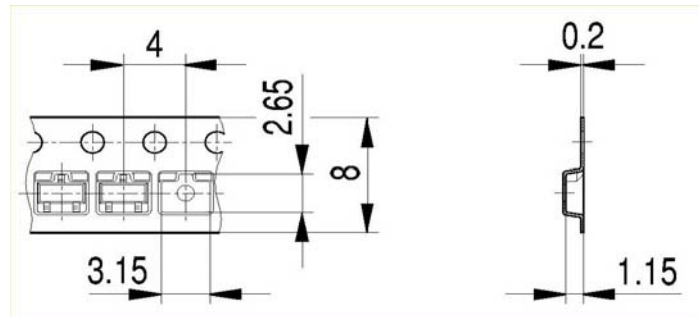

Published by
Infineon Technologies AG
Bereich Kommunikation
St.-Martin-Straße 53
D-81541 München
© Infineon Technologies AG 1999
All Rights Reserved.

Attention please!

The information herein is given to describe certain components and shall not be considered as warranted characteristics.

Terms of delivery and rights to technical change reserved.

We hereby disclaim any and all warranties, including but not limited to warranties of non-infringement, regarding circuits, descriptions and charts started herein.

Infineon Technologies is an approved CECC manufacturer.

Information

For further information on technology, delivery terms and conditions and prices, please contact your nearest Infineon Technologies office in Germany or our Infineon Technologies representatives worldwide (see address list).

Warnings

Due to technical requirements, components may contain dangerous substances.
For information on the types in question, please contact your nearest Infineon Technologies office.

Infineon Technologies' components may only be used in life-support devices or systems with the expressed written approval of Infineon Technologies if a failure of such components can reasonably be expected to cause the failure of that life-support device or system, or to affect the safety or effectiveness of that device or system. Life support devices or systems are intended to be implanted in the human body, or to support and/or maintain and sustain and/or protect human life. If they fail, it is reasonable to assume that the health of the user or other persons may be endangered.



LittleDiode supplies new, hard to find or obsolete electronic components and semiconductors all over the world.

With over two million different components listed you are sure to find the part you need.

Feel free to visit us today at our online store:

LittleDiode.com

Looking forward to providing you with the best possible service.