

INTERNATIONAL RECTIFIER



REPETITIVE AVALANCHE RATED AND  $dv/dt$  RATED

HEXFET<sup>®</sup> TRANSISTOR

IRFV460

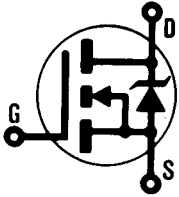

N-CHANNEL

500 Volt, 0.27 Ohm HEXFET

The HEXFET<sup>®</sup> technology is the key to International Rectifier's advanced line of power MOSFET transistors. The efficient geometry design achieves very low on-state resistance combined with high transconductance.

The HEXFET transistors also feature all of the well established advantages of MOSFETs such as voltage control, very fast switching, ease of paralleling and temperature stability of the electrical parameters.

They are well suited for applications such as switching power supplies and virtually any application where military and/or high reliability is required.

Product Summary

Part Number	$BV_{DSS}$	$R_{DS(on)}$	$I_D$
IRFV460	500V	0.27 $\Omega$	21A

FEATURES:

- Repetitive Avalanche Rating
- Dynamic  $dv/dt$  Rating
- Isolated and Hermetically Sealed
- Alternative to TO-3 Package
- Simple Drive Requirements
- Ease of Paralleling
- Ceramic Eyelets

CASE STYLE AND DIMENSIONS

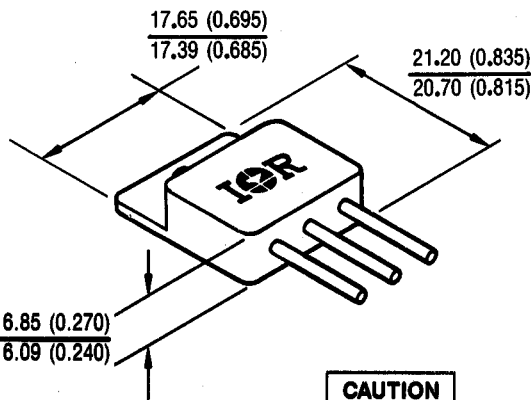

**CAUTION**

BERYLLIA WARNING PER MIL-S-19500  
SEE PAGE I-470

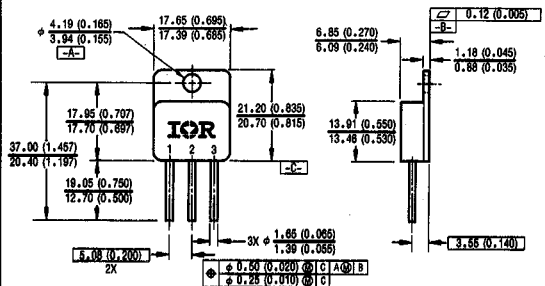

NOTES:

- 1 DIMENSIONING & TOLERANCING PER ANSI Y14.6M - 1982.
- 2 ALL DIMENSIONS ARE SHOWN IN MILLIMETERS (INCHES).

LEGEND

- 1 DRAIN
- 2 SOURCE
- 3 GATE

\*For optional leadforms see page I-470, fig. 15

Conforms to JEDEC Outline TO-258AA\*  
Dimensions in Millimeters and (Inches)

**Absolute Maximum Ratings**

Parameter		IRFV460	Units
$I_D$ @ $V_{GS} = 0V, T_C = 25^\circ C$	Continuous Drain Current	21	A
$I_D$ @ $V_{GS} = 0V, T_C = 100^\circ C$	Continuous Drain Current	13	
$I_{DM}$	Pulsed Drain Current ①	84	
$P_D$ @ $T_C = 25^\circ C$	Max. Power Dissipation	300	W
	Linear Derating Factor	2.4	W/K ⑤
$V_{GS}$	Gate-to-Source Voltage	$\pm 20$	V
$E_{AS}$	Single Pulse Avalanche Energy ②	480	mJ
$I_{AR}$	Avalanche Current ①	21	A
$E_{AR}$	Repetitive Avalanche Energy ①	30	mJ
$dv/dt$	Peak Diode Recovery $dv/dt$ ③	3.5	V/ns
$T_J$	Operating Junction	-55 to 150	°C
$T_{STG}$	Storage Temperature Range		
	Lead Temperature	300 (0.063 in. (1.6 mm) from case for 10s)	
	Weight	10.9 (typical)	g

**Electrical Characteristics @  $T_J = 25^\circ C$  (Unless Otherwise Specified)**

Parameter	Min.	Typ.	Max.	Units	Test Conditions
$BV_{DSS}$	500	—	—	V	$V_{GS} = 0V, I_D = 1.0 mA$
$\Delta BV_{DSS}/\Delta T_J$	—	0.63	—	V/°C	Reference to 25°C, $I_D = 1.0 mA$
$R_{DS(on)}$	—	—	0.27	$\Omega$	$V_{GS} = 10V, I_D = 13A$ ④
	—	—	0.31		$V_{GS} = 10V, I_D = 21A$
$V_{GS(th)}$	2.0	—	4.0	V	$V_{DS} = V_{GS}, I_D = 250 \mu A$
$g_{fs}$	13	—	—	S (Ω)	$V_{DS} = 15V, I_{DS} = 13A$ ④
$I_{DSS}$	—	—	25	$\mu A$	$V_{DS} = \text{Max. Rating}, V_{GS} = 0V$
	—	—	250		$V_{DS} = 0.8 \times \text{Max. Rating}$ $V_{GS} = 0V, T_J = 125^\circ C$
$I_{GSS}$	—	—	100	nA	$V_{GS} = 20V$
$I_{GSS}$	—	—	-100		$V_{GS} = -20V$
$Q_g$	—	—	190	nC	$V_{GS} = 10V, I_D = 21A$
$Q_{gs}$	—	—	27		$V_{DS} = 0.5 \times \text{Max. Rating}$
$Q_{gd}$	—	—	135		See Fig. 6 and 14
$t_d(on)$	—	—	35	ns	$V_{DD} = 250V, I_D = 21A, R_G = 2.350$
$t_r$	—	—	120		
$t_d(off)$	—	—	130		See Fig. 11
$t_f$	—	—	98		
$L_D$	—	8.7	—	nH	Measured from the drain lead, 6 mm (0.25 in.) from package to center of die.
$L_S$	—	8.7	—		Measured from the source lead, 6 mm (0.25 in.) from package to source bonding pad.
$C_{iss}$	—	4300	—	pF	$V_{GS} = 0V, V_{DS} = 25V$
$C_{oss}$	—	1000	—		$f = 1.0 MHz$
$C_{rss}$	—	250	—		See Fig. 5

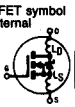

**Source-Drain Diode Ratings and Characteristics**

Parameter		Min.	Typ.	Max.	Units	Test Conditions
$I_S$	Continuous Source Current (Body Diode)	—	—	21	A	Modified MOSFET symbol showing the integral Reverse p-n junction rectifier. 
$I_{SM}$	Pulsed Source Current (Body Diode) ①	—	—	84		
$V_{SD}$	Diode Forward Voltage	—	—	1.8	V	$T_J = 25^\circ\text{C}$ , $I_S = 21\text{A}$ , $V_{GS} = 0\text{V}$ ④
$t_{rr}$	Reverse Recovery Time	—	—	580	nS	$T_J = 25^\circ\text{C}$ , $I_F = 21\text{A}$ , $di/dt \leq 100\text{ A}/\mu\text{s}$ ④
$Q_{RR}$	Reverse Recovery Charge	—	—	8.1	$\mu\text{C}$	$V_{DD} \leq 50\text{V}$
$t_{on}$	Forward Turn-On Time	Intrinsic turn-on time is negligible. Turn-on speed is substantially controlled by $L_S + L_D$ .				

**Thermal Resistance**

Parameter		Min.	Typ.	Max.	Units	Test Conditions
$R_{thJC}$	Junction-to-Case	—	—	0.42	K/W ⑤	
$R_{thCS}$	Case-to-Sink	—	0.21	—		Mounting surface flat, smooth, and greased
$R_{thJA}$	Junction-to-Ambient	—	—	30		Typical socket mount

① Repetitive Rating; Pulse width limited by maximum junction temperature (see figure 9) Refer to current HEXFET reliability report

② @  $V_{DD} = 50\text{V}$ , Starting  $T_J = 25^\circ\text{C}$ ,  $L \geq 2.0\text{ mH}$ ,  $R_G = 25\Omega$ , Peak  $I_L = 21\text{A}$

③  $I_{SD} \leq 21\text{A}$ ,  $di/dt \leq 160\text{ A}/\mu\text{s}$ ,  $V_{DD} \leq BVD_{SS}$ ,  $T_J \leq 150^\circ\text{C}$  Suggested  $R_G = 2.35\Omega$

④ Pulse width  $\leq 300\ \mu\text{s}$ ; Duty Cycle  $\leq 2\%$

⑤ K/W =  $^\circ\text{C}/\text{W}$   
W/K =  $\text{W}/^\circ\text{C}$

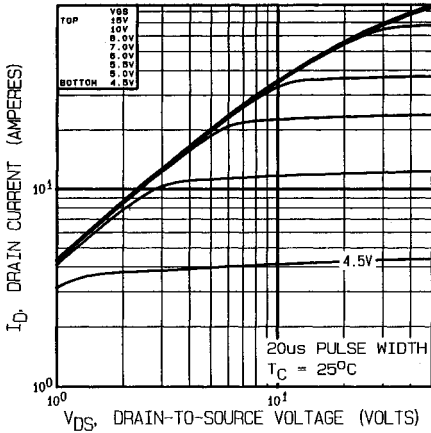

Fig. 1 — Typical Output Characteristics,  $T_C = 25^\circ\text{C}$

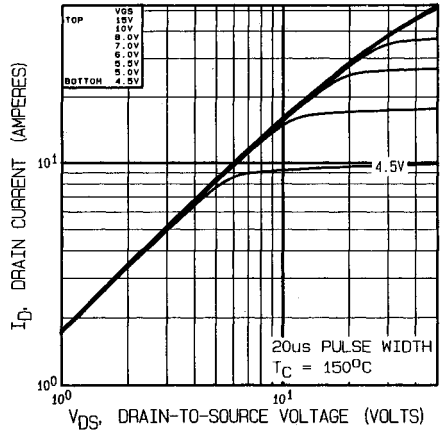

Fig. 2 — Typical Output Characteristics,  $T_C = 150^\circ\text{C}$

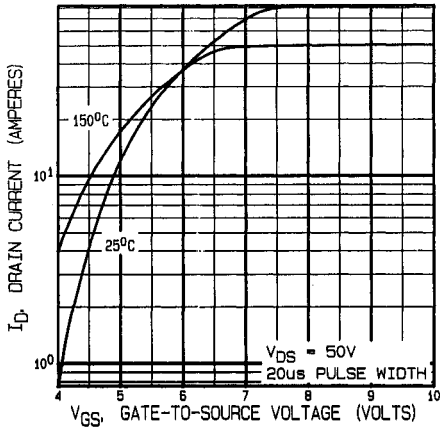

Fig. 3 — Typical Transfer Characteristics

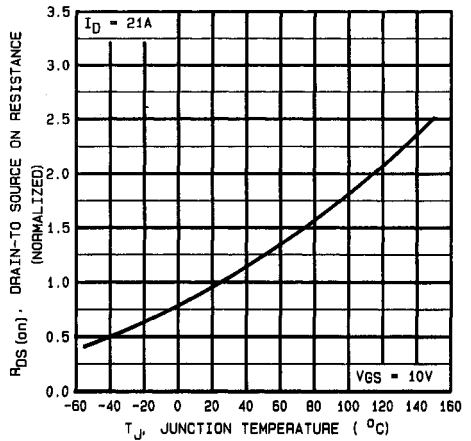
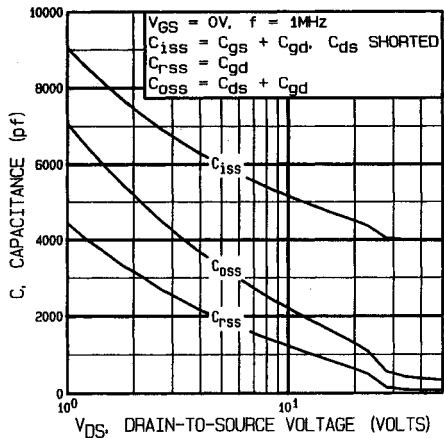
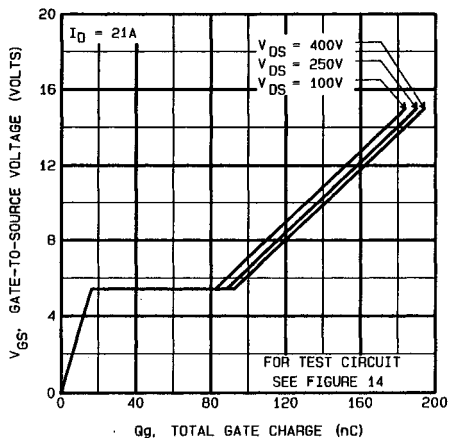
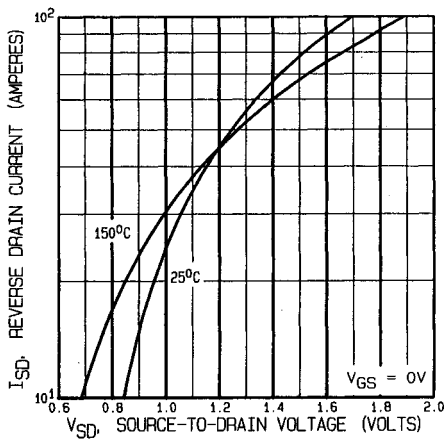
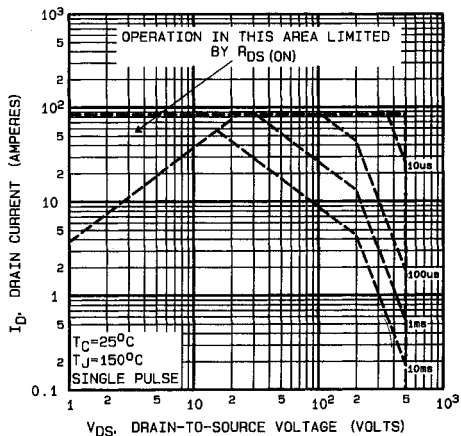

Fig. 4 — Normalized On-Resistance Vs. Temperature

**Fig. 5 -- Typical Capacitance Vs. Drain-to-Source Voltage**

**Fig. 6 -- Typical Gate Charge Vs. Gate-to-Source Voltage**

**Fig. 7 -- Typical Source-Drain Diode Forward Voltage**

**Fig. 8 -- Maximum Safe Operating Area**

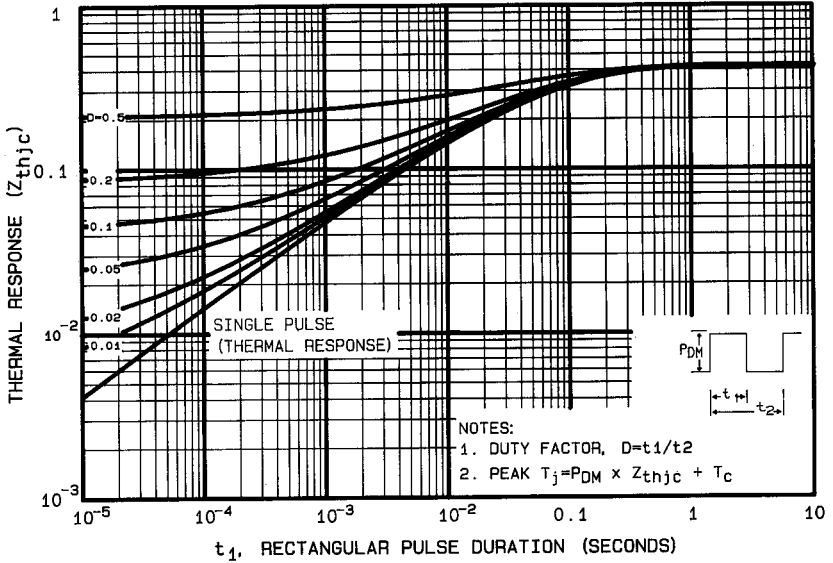

Fig. 9 — Maximum Effective Transient Thermal Impedance, Junction-to-Case Vs. Pulse Duration

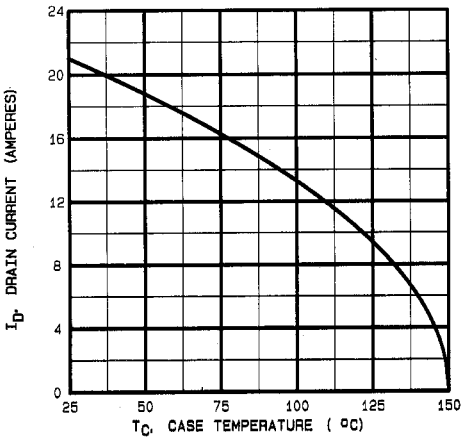

Fig. 10 — Maximum Drain Current Vs. Case Temperature

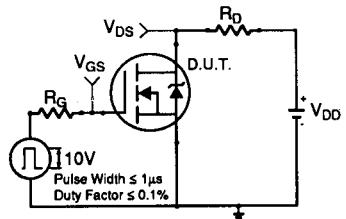

Fig. 11a — Switching Time Test Circuit

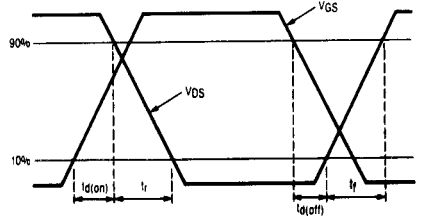
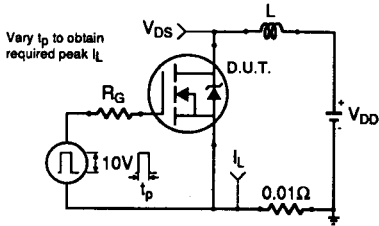
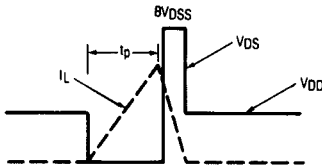
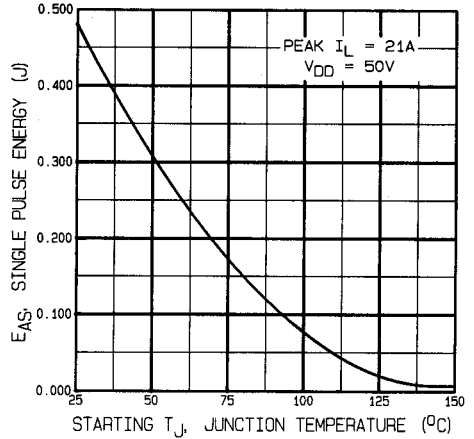
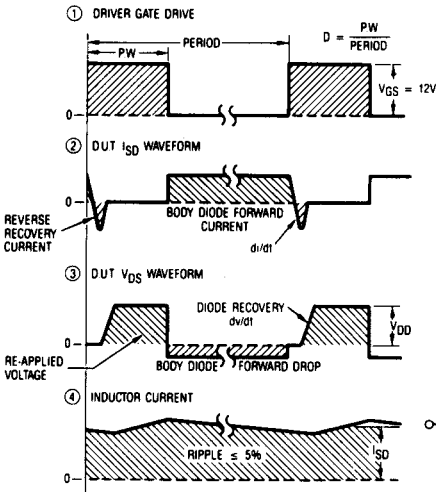
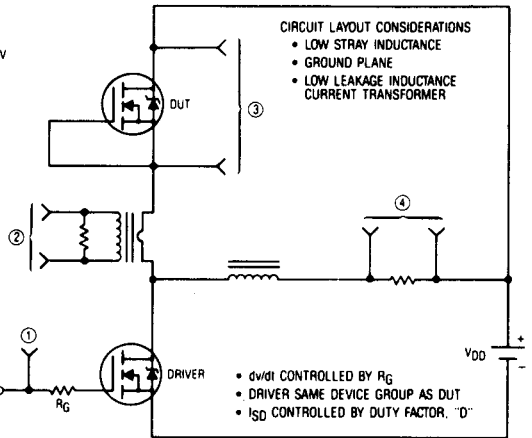

Fig. 11b — Switching Time Waveforms

**Fig. 12a — Unclamped Inductive Test Circuit**

**Fig. 12b — Unclamped Inductive Waveforms**

**Fig. 12c — Maximum Avalanche Energy Vs. Starting Junction Temperature**

**Fig. 13 — Peak Diode Recovery  $dv/dt$  Test Circuit**

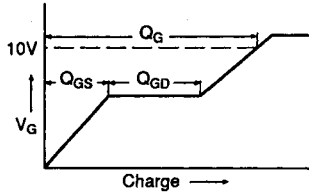

Fig. 14a — Basic Gate Charge Waveform

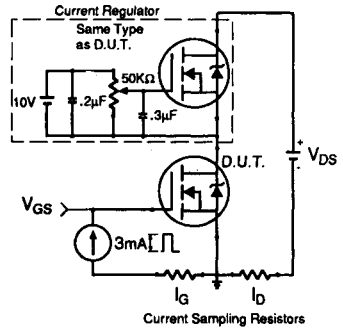

Fig. 14b — Gate Charge Test Circuit

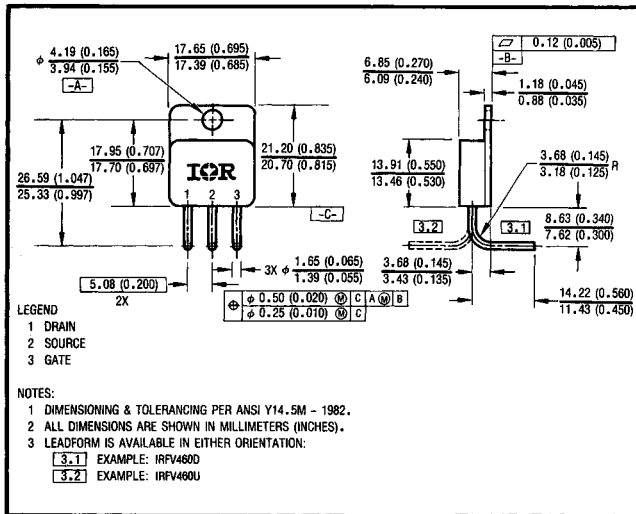

Fig. 15 — Optional Leadforms for Outline TO-258

**BERYLLIA WARNING PER MIL-S-19500**

Packages containing beryllia shall not be ground, sandblasted, machined, or have other operations performed on them which will produce beryllia or beryllium dust. Furthermore, beryllium oxide packages shall not be placed in acids that will produce fumes containing beryllium.



### IRFY Series Data Sheet

The IRFY Data Sheet describes 12 devices, 8 N-Channel and 4 P-Channel, all contained in the TO-257AB package. This data sheet is arranged to show common tabular and graphical information between devices.

Absolute maximum ratings and parametric data are presented in tabular format with devices grouped according to generically shared parameters. For each parametric rating, devices are categorized by N and P channel and listed in alpha-numeric order. The conditions specified for a given parametric test are provided in the right hand column of each table.

Graphical information is grouped by devices in

alphabetical order. Where the information is device specific, we have assigned a numeric character for the graph type and an alpha character to a given device. (See Table A below). Where graphs are polarity specific as in figures 10, 12, 14 and 15, we have indicated N-Channel or P-Channel. The Thermal Impedance Graph (Fig. 11) is the only exception where a graph is common to both N-Channel and P-Channel devices since the thermal impedance is only dependent on the die size and package.

In Table A below, a legend is provided cross referencing the part number to its assigned alpha code. A given device will retain this alpha code for each device specific graph.

Table A

DEVICE	ALPHA DESIGNATION
IRFY044	a
IRFY120	b
IRFY130	c
IRFY140	d
IRFY240	e
IRFY340	f
IRFY430	g
IRFY440	h
IRFY9120	i
IRFY9130	j
IRFY9140	k
IRFY9240	l

# IRFF Series Devices



## HEXFET, CECC Qualified — Europe

### TO257/HEXFET/N-Channel

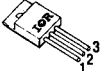
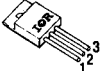
Basic Type	V <sub>DS</sub> (V)	R <sub>DS(on)</sub> (Ohms)	CECC Specification	Issue No.	Issue Date	Level of Quality Assessment and CECC 50 000 Screen Level Options	Case Outline												
IRFY044(M)	60	0.03	50 012-062	1	10/91	E-,EA,EB,EC,ED	<b>TO-257AA</b> <b>Y-PAK</b> 												
IRFY120(M)	100	0.31	50 012-060			E-,EA,EB,EC,ED													
IRFY130(M)	100	0.19	50 012-061			E-,EA,EB,EC,ED													
IRFY140(M)	100	0.092	50 012-062			E-,EA,EB,EC,ED													
IRFY240(M)	200	0.19	50 012-062			E-,EA,EB,EC,ED													
IRFY340(M)	400	0.55	50 012-062			E-,EA,EB,EC,ED													
IRFY430(M)	500	1.50	50 012-061			E-,EA,EB,EC,ED													
IRFY440(M)	500	0.85	50 012-062			E-,EA,EB,EC,ED													
TO257/HEXFET/P-Channel								 <table border="1" data-bbox="806 445 936 501"> <tr> <td></td> <td>1</td> <td>2</td> <td>3</td> </tr> <tr> <td>IRFY</td> <td>G</td> <td>D</td> <td>S</td> </tr> <tr> <td>IRFY(M)</td> <td>D</td> <td>S</td> <td>G</td> </tr> </table>		1	2	3	IRFY	G	D	S	IRFY(M)	D	S
	1	2	3																
IRFY	G	D	S																
IRFY(M)	D	S	G																
IRFY9120(M)	-100	0.60	50 012-063	1	10/91	E-,EA,EB,EC,ED													
IRFY9130(M)	-100	0.31	50 012-064			E-,EA,EB,EC,ED													
IRFY9140(M)	-100	0.21	50 012-065			E-,EA,EB,EC,ED													
IRFY9240(M)	-200	0.50	50 012-065			E-,EA,EB,EC,ED													
						E-,EA,EB,EC,ED													

FOR OTHER GOVERNMENT/SPACE QUALIFIED PRODUCTS SEE SECTION E.



LittleDiode supplies new, hard to find or obsolete electronic components and semiconductors all over the world.

With over two million different components listed you are sure to find the part you need.

Feel free to visit us today at our online store:

[LittleDiode.com](http://LittleDiode.com)

Looking forward to providing you with the best possible service.