

IRFL024N

HEXFET® Power MOSFET

- Surface Mount
- Advanced Process Technology
- Ultra Low On-Resistance
- Dynamic dv/dt Rating
- Fast Switching
- Fully Avalanche Rated

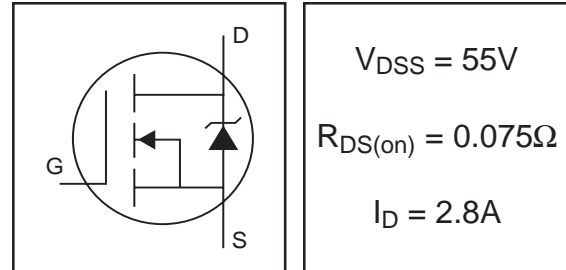

Description

Fifth Generation HEXFETs from International Rectifier utilize advanced processing techniques to achieve extremely low on-resistance per silicon area. This benefit, combined with the fast switching speed and ruggedized device design that HEXFET Power MOSFETs are well known for, provides the designer with an extremely efficient and reliable device for use in a wide variety of applications.

The SOT-223 package is designed for surface-mount using vapor phase, infra red, or wave soldering techniques. Its unique package design allows for easy automatic pick-and-place as with other SOT or SOIC packages but has the added advantage of improved thermal performance due to an enlarged tab for heatsinking. Power dissipation of 1.0W is possible in a typical surface mount application.

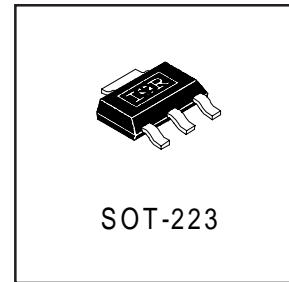

Absolute Maximum Ratings

| | Parameter | Max. | Units |
|--------------------------|---|--------------|-------|
| $I_D @ T_A = 25^\circ C$ | Continuous Drain Current, $V_{GS} @ 10V^{**}$ | 4.0 | A |
| $I_D @ T_A = 25^\circ C$ | Continuous Drain Current, $V_{GS} @ 10V^*$ | 2.8 | |
| $I_D @ T_A = 70^\circ C$ | Continuous Drain Current, $V_{GS} @ 10V^*$ | 2.3 | |
| I_{DM} | Pulsed Drain Current ① | 11.2 | |
| $P_D @ T_A = 25^\circ C$ | Power Dissipation (PCB Mount)** | 2.1 | W |
| $P_D @ T_A = 25^\circ C$ | Power Dissipation (PCB Mount)* | 1.0 | W |
| | Linear Derating Factor (PCB Mount)* | 8.3 | mW/°C |
| V_{GS} | Gate-to-Source Voltage | ± 20 | V |
| E_{AS} | Single Pulse Avalanche Energy② | 214 | mJ |
| I_{AR} | Avalanche Current① | 2.8 | A |
| E_{AR} | Repetitive Avalanche Energy①* | 0.1 | mJ |
| dv/dt | Peak Diode Recovery dv/dt ③ | 5.0 | V/ns |
| T_J, T_{STG} | Junction and Storage Temperature Range | -55 to + 150 | °C |

Thermal Resistance

| | Parameter | Typ. | Max. | Units |
|-----------------|--|------|------|-------|
| $R_{\theta JA}$ | Junction-to-Amb. (PCB Mount, steady state)* | 90 | 120 | °C/W |
| $R_{\theta JA}$ | Junction-to-Amb. (PCB Mount, steady state)** | 50 | 60 | |

* When mounted on FR-4 board using minimum recommended footprint.

** When mounted on 1 inch square copper board, for comparison with other SMD devices.

Electrical Characteristics @ $T_J = 25^\circ\text{C}$ (unless otherwise specified)

| | Parameter | Min. | Typ. | Max. | Units | Conditions |
|---------------------------------|--------------------------------------|------|-------|-------|---------------------|--|
| $V_{(BR)DSS}$ | Drain-to-Source Breakdown Voltage | 55 | — | — | V | $V_{GS} = 0V, I_D = 250\mu A$ |
| $\Delta V_{(BR)DSS}/\Delta T_J$ | Breakdown Voltage Temp. Coefficient | — | 0.056 | — | V/ $^\circ\text{C}$ | Reference to $25^\circ\text{C}, I_D = 1\text{mA}$ |
| $R_{DS(on)}$ | Static Drain-to-Source On-Resistance | — | — | 0.075 | Ω | $V_{GS} = 10V, I_D = 2.8A$ ④ |
| $V_{GS(th)}$ | Gate Threshold Voltage | 2.0 | — | 4.0 | V | $V_{DS} = V_{GS}, I_D = 250\mu A$ |
| g_{fs} | Forward Transconductance | 3.0 | — | — | S | $V_{DS} = 25V, I_D = 1.68A$ |
| I_{DSS} | Drain-to-Source Leakage Current | — | — | 25 | μA | $V_{DS} = 55V, V_{GS} = 0V$ |
| | | — | — | 250 | | $V_{DS} = 44V, V_{GS} = 0V, T_J = 125^\circ\text{C}$ |
| I_{GSS} | Gate-to-Source Forward Leakage | — | — | 100 | nA | $V_{GS} = 20V$ |
| | Gate-to-Source Reverse Leakage | — | — | -100 | | $V_{GS} = -20V$ |
| Q_g | Total Gate Charge | — | — | 18.3 | nC | $I_D = 1.68A$ |
| Q_{gs} | Gate-to-Source Charge | — | — | 3.0 | | $V_{DS} = 44V$ |
| Q_{gd} | Gate-to-Drain ("Miller") Charge | — | — | 7.7 | | $V_{GS} = 10V$, See Fig. 6 and 9 ④ |
| $t_{d(on)}$ | Turn-On Delay Time | — | 8.1 | — | ns | $V_{DD} = 28V$ |
| t_r | Rise Time | — | 13.4 | — | | $I_D = 1.68A$ |
| $t_{d(off)}$ | Turn-Off Delay Time | — | 22.2 | — | | $R_G = 24\Omega$ |
| t_f | Fall Time | — | 17.7 | — | | $R_D = 17\Omega$, See Fig. 10 ④ |
| C_{iss} | Input Capacitance | — | 400 | — | pF | $V_{GS} = 0V$ |
| C_{oss} | Output Capacitance | — | 145 | — | | $V_{DS} = 25V$ |
| C_{rss} | Reverse Transfer Capacitance | — | 60 | — | | $f = 1.0\text{MHz}$, See Fig. 5 |

Source-Drain Ratings and Characteristics

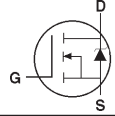
| | Parameter | Min. | Typ. | Max. | Units | Conditions |
|----------|--|---|------|------|-------|--|
| I_S | Continuous Source Current (Body Diode) | — | — | 2.8 | A | MOSFET symbol showing the integral reverse p-n junction diode.  |
| I_{SM} | Pulsed Source Current (Body Diode) ① | — | — | 11.2 | | |
| V_{SD} | Diode Forward Voltage | — | — | 1.0 | V | $T_J = 25^\circ\text{C}, I_S = 1.68A, V_{GS} = 0V$ ④ |
| t_{rr} | Reverse Recovery Time | — | 35 | 53 | ns | $T_J = 25^\circ\text{C}, I_F = 1.68A$ |
| Q_{rr} | Reverse Recovery Charge | — | 50 | 75 | nC | $di/dt = 100A/\mu s$ ④ |
| t_{on} | Forward Turn-On Time | Intrinsic turn-on time is negligible (turn-on is dominated by $L_S + L_D$) | | | | |

Notes:

- ① Repetitive rating; pulse width limited by max. junction temperature. (See fig. 11)
- ② Starting $T_J = 25^\circ\text{C}, L = 54.7\text{mH}$
 $R_G = 25\Omega, I_{AS} = 2.8A$. (See Figure 12)
- ③ $I_{SD} \leq 1.68A, di/dt \leq 155A/\mu s, V_{DD} \leq V_{(BR)DSS}, T_J \leq 150^\circ\text{C}$
- ④ Pulse width $\leq 300\mu s$; duty cycle $\leq 2\%$.

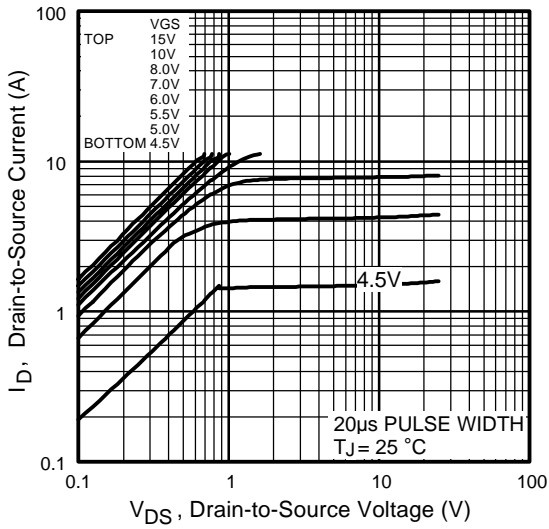

Fig 1. Typical Output Characteristics,

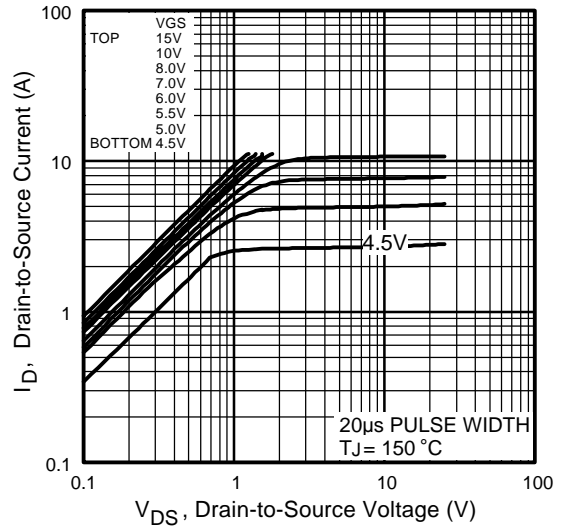

Fig 2. Typical Output Characteristics,

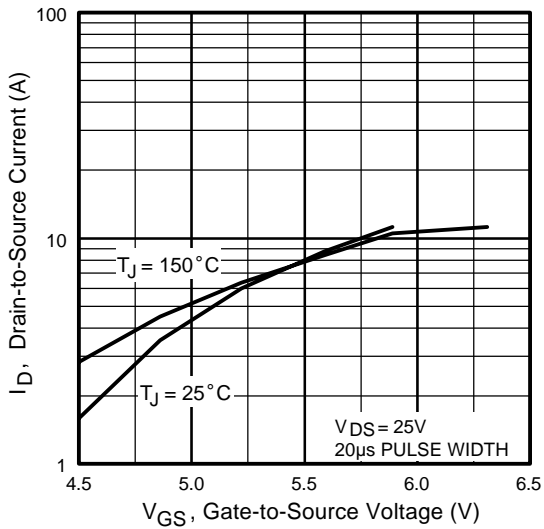

Fig 3. Typical Transfer Characteristics

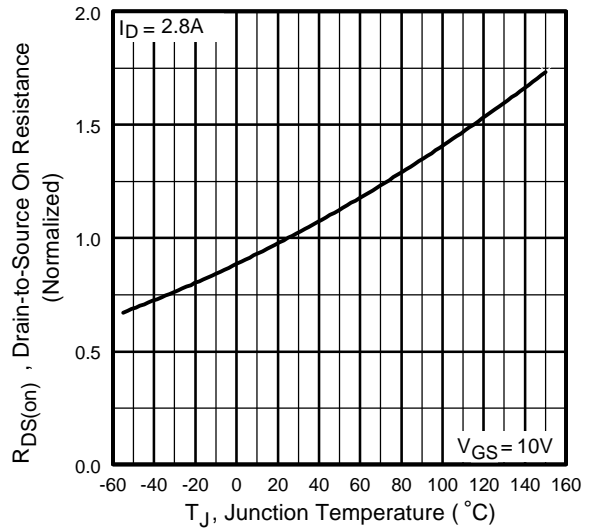

Fig 4. Normalized On-Resistance Vs. Temperature

IRFL024N

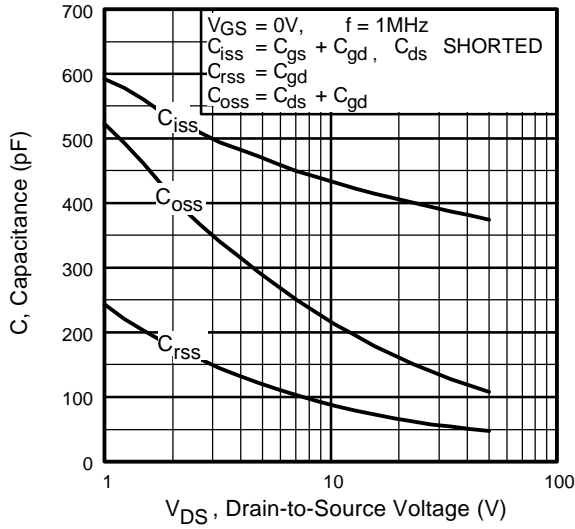

Fig 5. Typical Capacitance Vs. Drain-to-Source Voltage

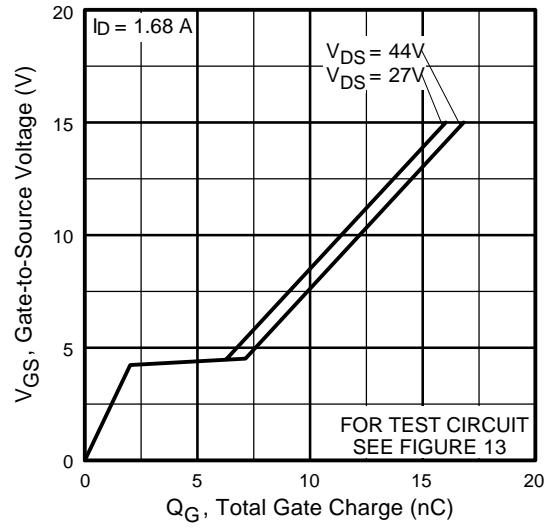

Fig 6. Typical Gate Charge Vs. Gate-to-Source Voltage

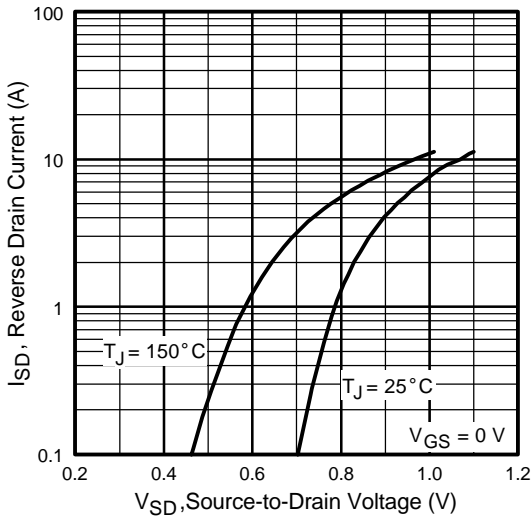

Fig 7. Typical Source-Drain Diode Forward Voltage

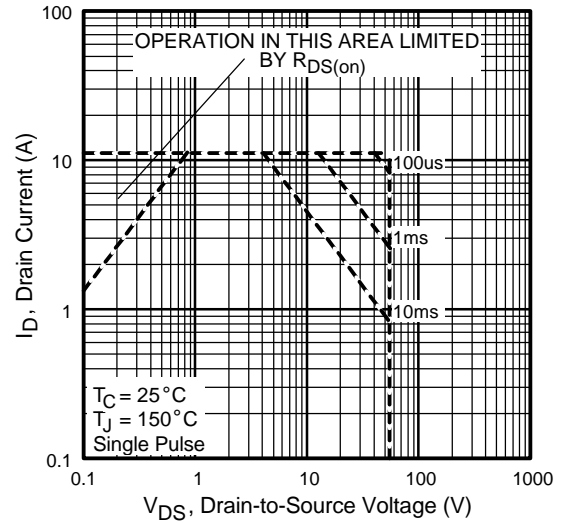

Fig 8. Maximum Safe Operating Area

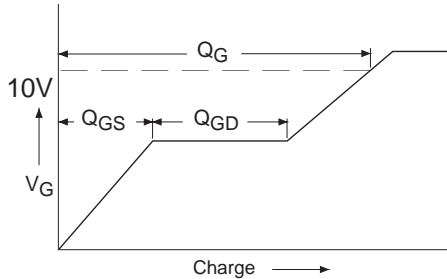

Fig 9a. Basic Gate Charge Waveform

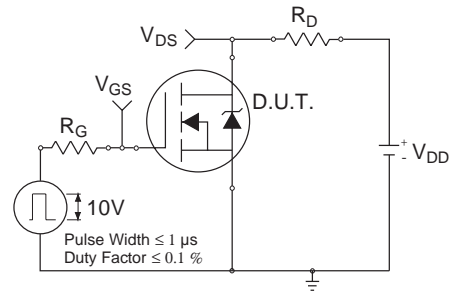

Fig 10a. Switching Time Test Circuit

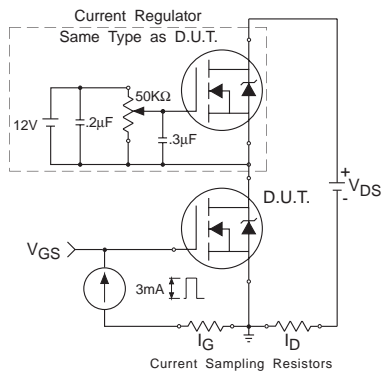

Fig 9b. Gate Charge Test Circuit

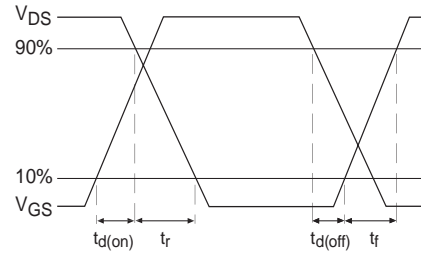

Fig 10b. Switching Time Waveforms

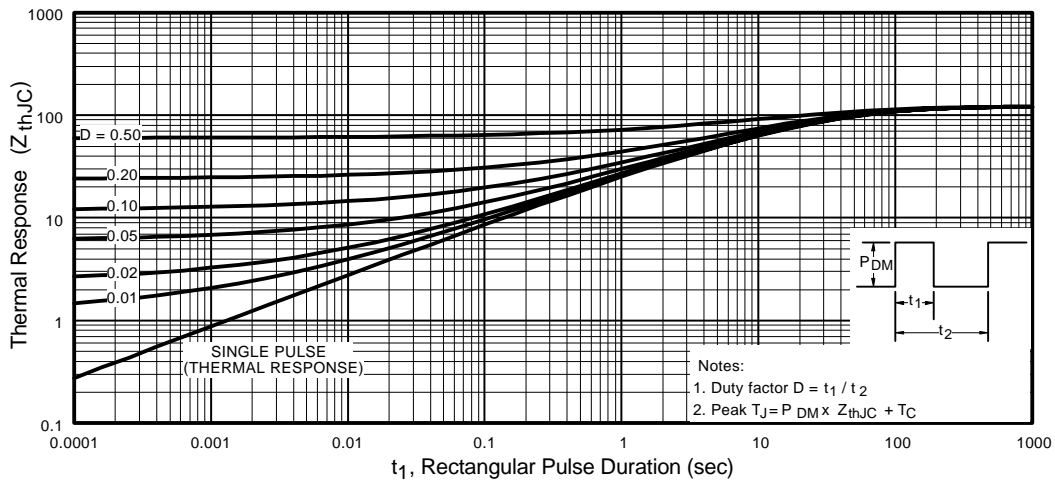

Fig 11. Maximum Effective Transient Thermal Impedance, Junction-to-Ambient

IRFL024N

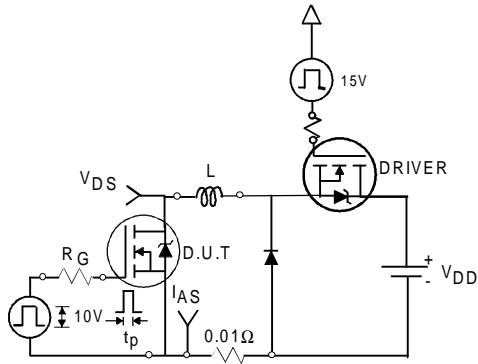

Fig 12a. Unclamped Inductive Test Circuit

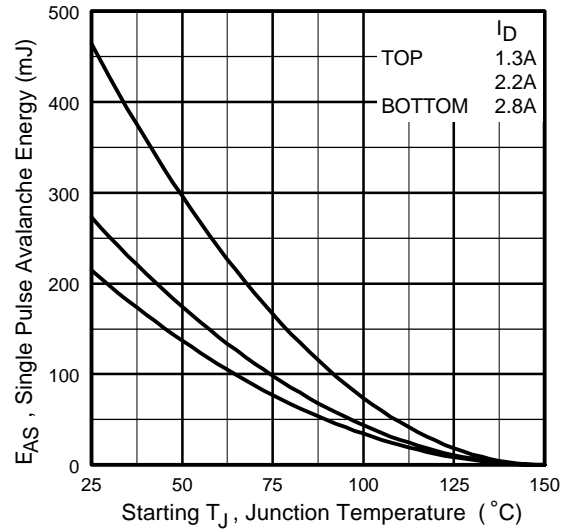

Fig 12c. Maximum Avalanche Energy Vs. Drain Current

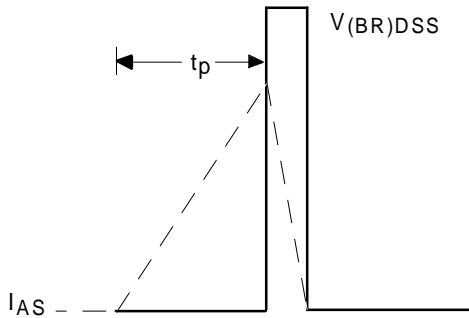
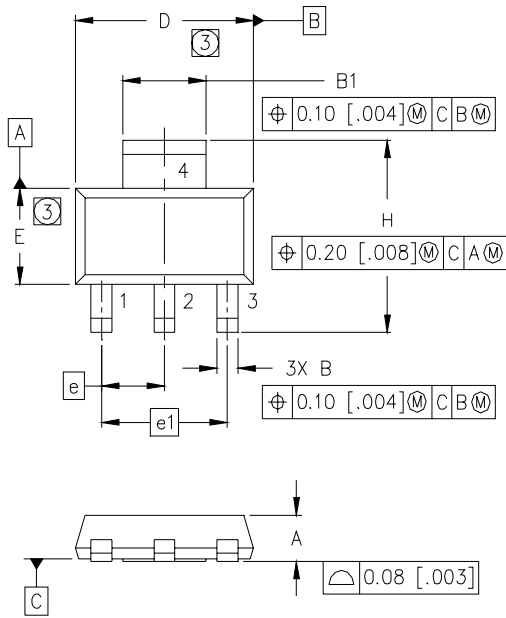

Fig 12b. Unclamped Inductive Waveforms

International
IR Rectifier
Package Outline
SOT-223 (TO-261AA) Outline

IRFL024N



| DIM | MILLIMETERS | | INCHES | |
|----------|-------------|------|--------|------|
| | MIN | MAX | MIN | MAX |
| A | 1.55 | 1.80 | .061 | .071 |
| B | 0.65 | 0.85 | .026 | .033 |
| B1 | 2.95 | 3.15 | .116 | .124 |
| C | 0.25 | 0.35 | .010 | .014 |
| D | 6.30 | 6.70 | .248 | .264 |
| E | 3.30 | 3.70 | .130 | .146 |
| e | 2.30 | BSC | .0905 | BSC |
| e1 | 4.60 | BSC | .181 | BSC |
| H | 6.71 | 7.29 | .264 | .287 |
| L | 0.91 | — | .036 | — |
| L1 | 0.061 | BSC | .0024 | BSC |
| θ | — | 10° | — | 10° |

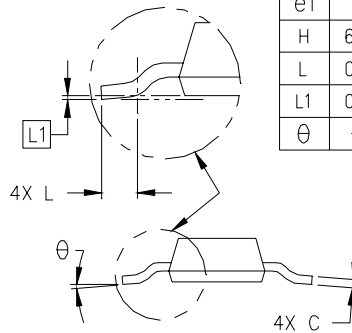

MINIMUM RECOMMENDED FOOTPRINT

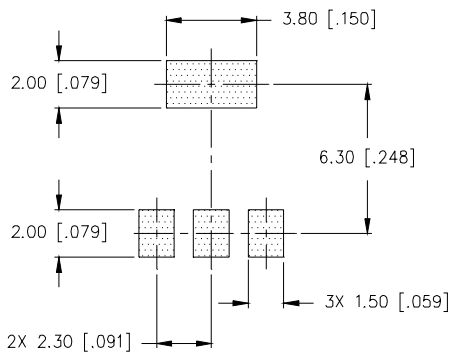

LEAD ASSIGNMENTS

- 1 = GATE
- 2 = DRAIN
- 3 = SOURCE
- 4 = DRAIN

NOTES:

1. DIMENSIONING & TOLERANCING PER ASME Y14.5M-1994.
2. CONTROLLING DIMENSION: INCH.
- ③ DIMENSIONS DO NOT INCLUDE MOLD FLASH.
4. OUTLINE CONFORMS TO JEDEC OUTLINE TO-261AA.
5. DIMENSIONS ARE SHOWN IN MILLIMETERS [INCHES].

Part Marking Information

SOT-223

EXAMPLE : THIS IS AN IRFL014

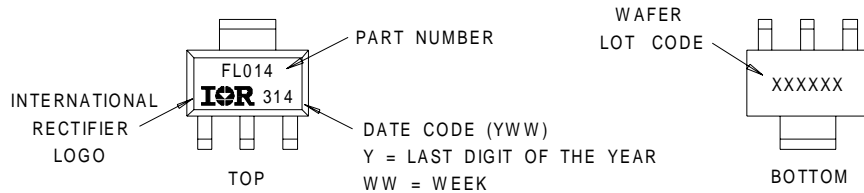



LittleDiode supplies new, hard to find or obsolete electronic components and semiconductors all over the world.

With over two million different components listed you are sure to find the part you need.

Feel free to visit us today at our online store:

LittleDiode.com

Looking forward to providing you with the best possible service.