

**Features**

- Advanced Process Technology
- Ultra Low On-Resistance
- 175°C Operating Temperature
- Fast Switching
- Repetitive Avalanche Allowed up to Tjmax

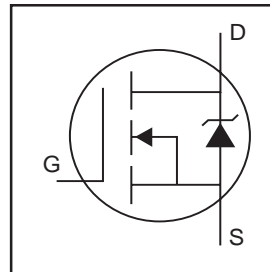

$V_{DS} = 40V$
$R_{DS(on)} = 9.0m\Omega$
$I_D = 42A$

**Description**

Specifically designed for Automotive applications, this HEXFET® Power MOSFET utilizes the latest processing techniques to achieve extremely low on-resistance per silicon area. Additional features of this design are a 175°C junction operating temperature, fast switching speed and improved repetitive avalanche rating. These features combine to make this design an extremely efficient and reliable device for use in Automotive applications and a wide variety of other applications.

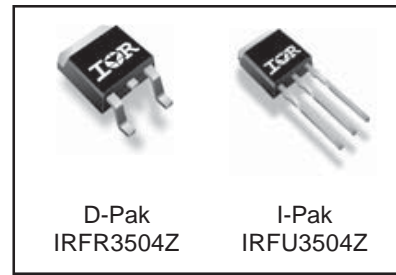

**Absolute Maximum Ratings**

	Parameter	Max.	Units
$I_D @ T_C = 25^\circ C$	Continuous Drain Current, $V_{GS} @ 10V$ (Silicon Limited)	77	A
$I_D @ T_C = 100^\circ C$	Continuous Drain Current, $V_{GS} @ 10V$	54	
$I_D @ T_C = 25^\circ C$	Continuous Drain Current, $V_{GS} @ 10V$ (Package Limited)	42	
$I_{DM}$	Pulsed Drain Current ①	310	
$P_D @ T_C = 25^\circ C$	Power Dissipation	90	W
	Linear Derating Factor	0.60	W/°C
$V_{GS}$	Gate-to-Source Voltage	$\pm 20$	V
$E_{AS}$ (Thermally limited)	Single Pulse Avalanche Energy②	77	mJ
$E_{AS}$ (Tested )	Single Pulse Avalanche Energy Tested Value ③	110	
$I_{AR}$	Avalanche Current ④	See Fig.12a, 12b, 15, 16	A
$E_{AR}$	Repetitive Avalanche Energy ⑤		mJ
$T_J$	Operating Junction and	-55 to + 175	°C
$T_{STG}$	Storage Temperature Range		
	Soldering Temperature, for 10 seconds	300 (1.6mm from case )	
	Mounting Torque, 6-32 or M3 screw	10 lbf•in (1.1N•m)	

**Thermal Resistance**

	Parameter	Typ.	Max.	Units
$R_{\theta JC}$	Junction-to-Case	—	1.66	°C/W
$R_{\theta JA}$	Junction-to-Ambient (PCB mount) ⑦	—	40	
$R_{\theta JA}$	Junction-to-Ambient	—	110	

HEXFET® is a registered trademark of International Rectifier.

### Electrical Characteristics @ T<sub>J</sub> = 25°C (unless otherwise specified)

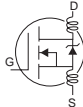
	Parameter	Min.	Typ.	Max.	Units	Conditions
V <sub>(BR)DSS</sub>	Drain-to-Source Breakdown Voltage	40	—	—	V	V <sub>GS</sub> = 0V, I <sub>D</sub> = 250μA
ΔV <sub>(BR)DSS</sub> /ΔT <sub>J</sub>	Breakdown Voltage Temp. Coefficient	—	0.032	—	V/°C	Reference to 25°C, I <sub>D</sub> = 1mA
R <sub>DS(on)</sub>	Static Drain-to-Source On-Resistance	—	8.23	9.0	mΩ	V <sub>GS</sub> = 10V, I <sub>D</sub> = 42A ③
V <sub>GS(th)</sub>	Gate Threshold Voltage	2.0	—	4.0	V	V <sub>DS</sub> = V <sub>GS</sub> , I <sub>D</sub> = 250μA
g <sub>fs</sub>	Forward Transconductance	32	—	—	S	V <sub>DS</sub> = 10V, I <sub>D</sub> = 42A
I <sub>DSS</sub>	Drain-to-Source Leakage Current	—	—	20	μA	V <sub>DS</sub> = 40V, V <sub>GS</sub> = 0V
		—	—	250		V <sub>DS</sub> = 40V, V <sub>GS</sub> = 0V, T <sub>J</sub> = 125°C
I <sub>GSS</sub>	Gate-to-Source Forward Leakage	—	—	200	nA	V <sub>GS</sub> = 20V
	Gate-to-Source Reverse Leakage	—	—	-200		V <sub>GS</sub> = -20V
Q <sub>g</sub>	Total Gate Charge	—	30	45	nC	I <sub>D</sub> = 42A
Q <sub>gs</sub>	Gate-to-Source Charge	—	9.6	—		V <sub>DS</sub> = 32V
Q <sub>gd</sub>	Gate-to-Drain ("Miller") Charge	—	12	—		V <sub>GS</sub> = 10V ③
t <sub>d(on)</sub>	Turn-On Delay Time	—	15	—	ns	V <sub>DD</sub> = 20V
t <sub>r</sub>	Rise Time	—	74	—		I <sub>D</sub> = 42A
t <sub>d(off)</sub>	Turn-Off Delay Time	—	30	—		R <sub>G</sub> = 15 Ω
t <sub>f</sub>	Fall Time	—	38	—		V <sub>GS</sub> = 10V ③
L <sub>D</sub>	Internal Drain Inductance	—	4.5	—	nH	Between lead, 6mm (0.25in.) from package and center of die contact
L <sub>S</sub>	Internal Source Inductance	—	7.5	—		
C <sub>iss</sub>	Input Capacitance	—	1510	—	pF	V <sub>GS</sub> = 0V
C <sub>oss</sub>	Output Capacitance	—	340	—		V <sub>DS</sub> = 25V
C <sub>rss</sub>	Reverse Transfer Capacitance	—	190	—		f = 1.0MHz
C <sub>oss</sub>	Output Capacitance	—	1100	—		V <sub>GS</sub> = 0V, V <sub>DS</sub> = 1.0V, f = 1.0MHz
C <sub>oss</sub>	Output Capacitance	—	340	—		V <sub>GS</sub> = 0V, V <sub>DS</sub> = 32V, f = 1.0MHz
C <sub>oss eff.</sub>	Effective Output Capacitance	—	460	—		V <sub>GS</sub> = 0V, V <sub>DS</sub> = 0V to 32V ④

### Source-Drain Ratings and Characteristics

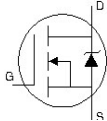
	Parameter	Min.	Typ.	Max.	Units	Conditions
I <sub>S</sub>	Continuous Source Current (Body Diode)	—	—	42	A	MOSFET symbol showing the integral reverse p-n junction diode.
I <sub>SM</sub>	Pulsed Source Current (Body Diode) ①	—	—	310		
V <sub>SD</sub>	Diode Forward Voltage	—	—	1.3	V	T <sub>J</sub> = 25°C, I <sub>S</sub> = 42A, V <sub>GS</sub> = 0V ③
t <sub>rr</sub>	Reverse Recovery Time	—	18	27	ns	T <sub>J</sub> = 25°C, I <sub>F</sub> = 42A, V <sub>DD</sub> = 20V
Q <sub>rr</sub>	Reverse Recovery Charge	—	9.2	14	nC	di/dt = 100A/μs ③
t <sub>on</sub>	Forward Turn-On Time	Intrinsic turn-on time is negligible (turn-on is dominated by LS+LD)				

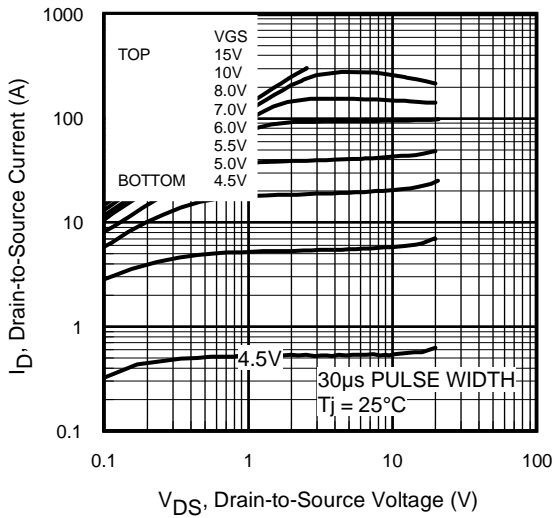

**Fig 1.** Typical Output Characteristics

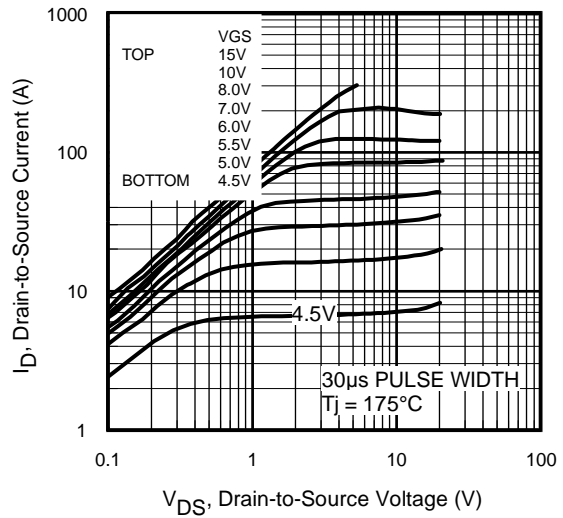

**Fig 2.** Typical Output Characteristics

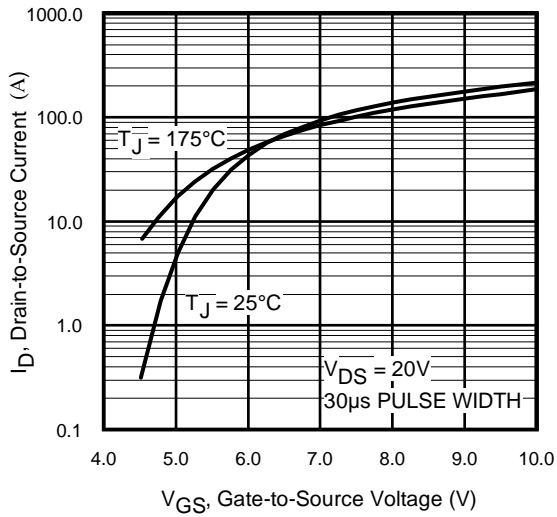

**Fig 3.** Typical Transfer Characteristics

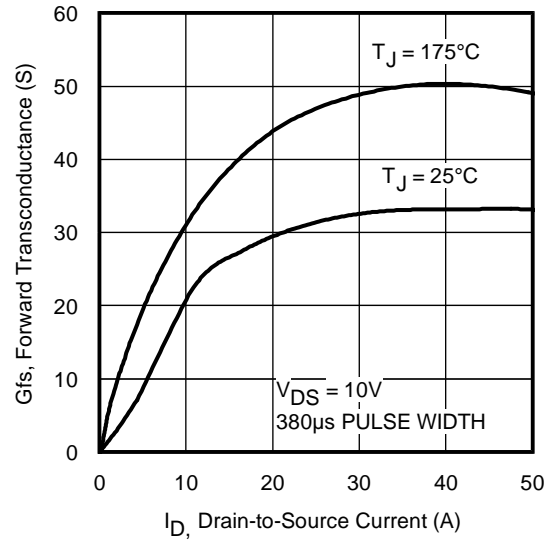

**Fig 4.** Typical Forward Transconductance Vs. Drain Current

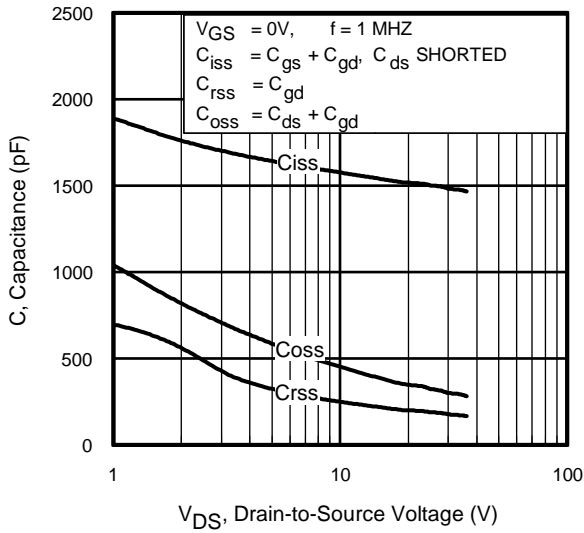

**Fig 5.** Typical Capacitance Vs. Drain-to-Source Voltage

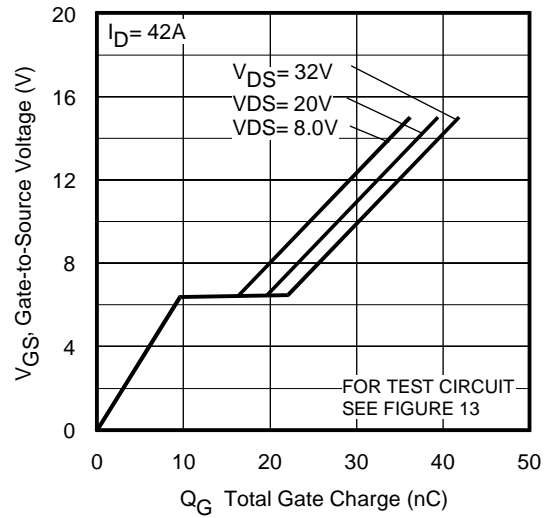

**Fig 6.** Typical Gate Charge Vs. Gate-to-Source Voltage

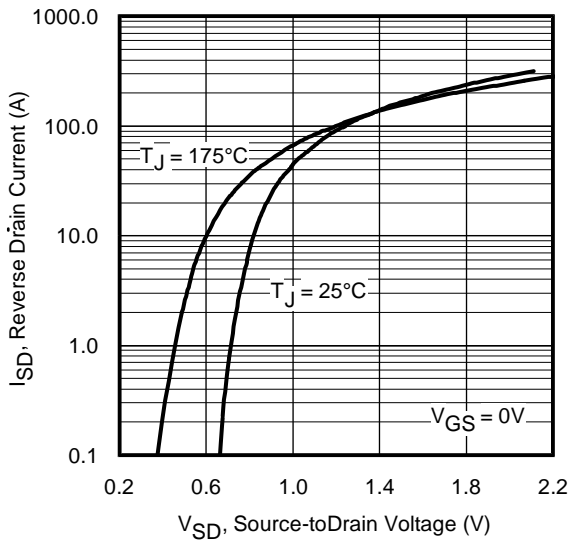

**Fig 7.** Typical Source-Drain Diode Forward Voltage

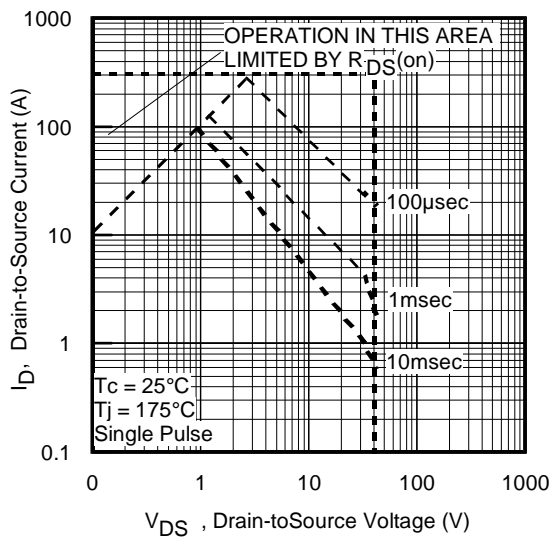

**Fig 8.** Maximum Safe Operating Area

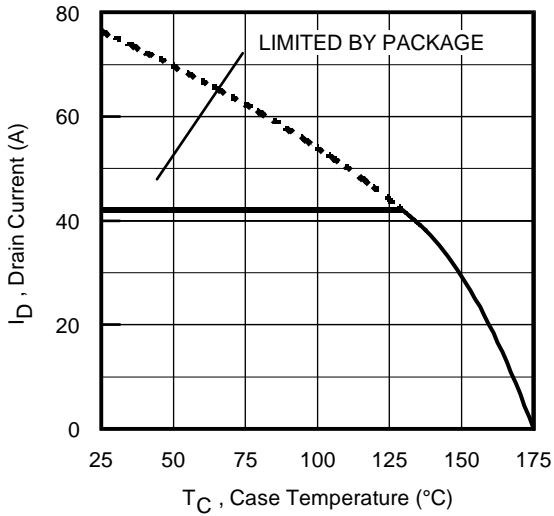

Fig 9. Maximum Drain Current Vs. Case Temperature

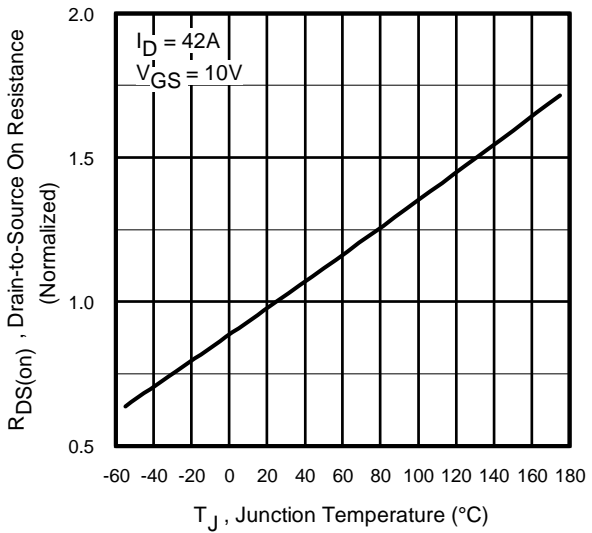

Fig 10. Normalized On-Resistance Vs. Temperature

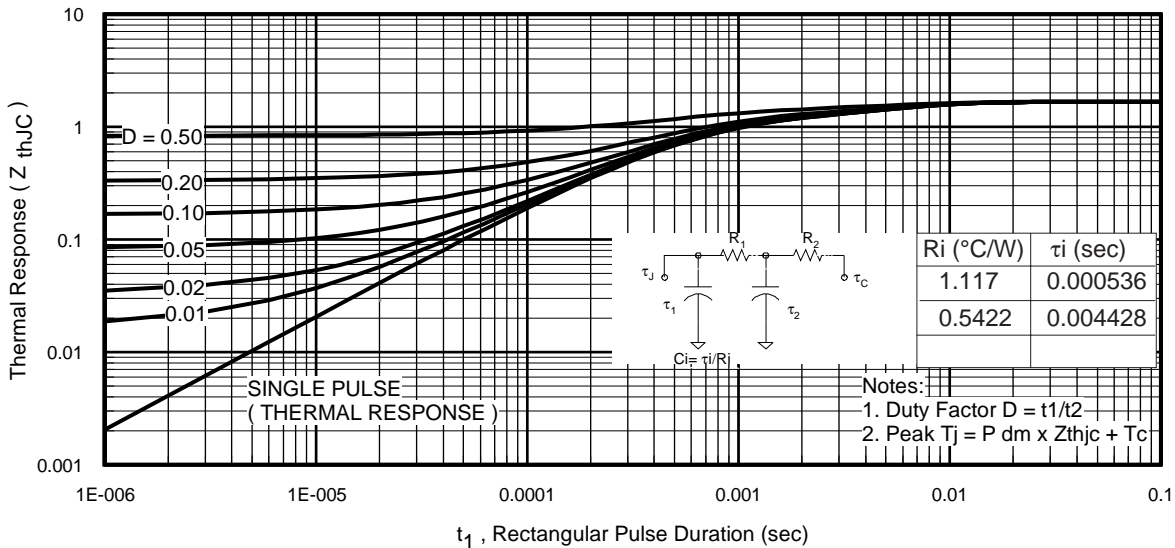
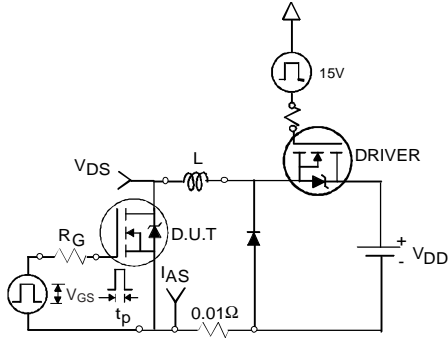
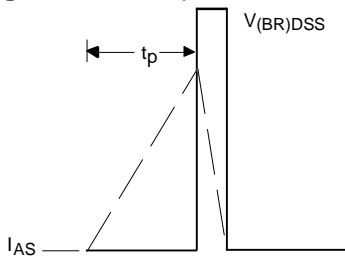

Fig 11. Maximum Effective Transient Thermal Impedance, Junction-to-Case

# IRFR/U3504Z



**Fig 12a.** Unclamped Inductive Test Circuit



**Fig 12b.** Unclamped Inductive Waveforms

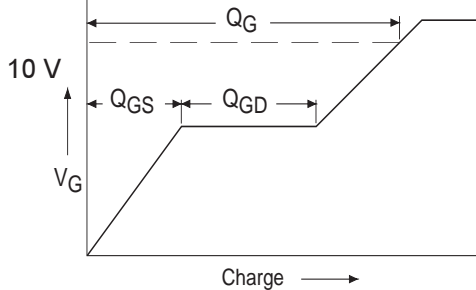

**Fig 13a.** Basic Gate Charge Waveform

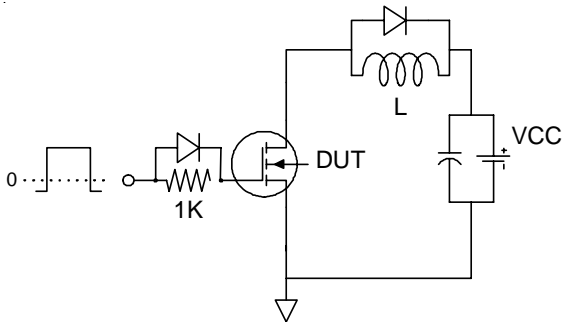

**Fig 13b.** Gate Charge Test Circuit

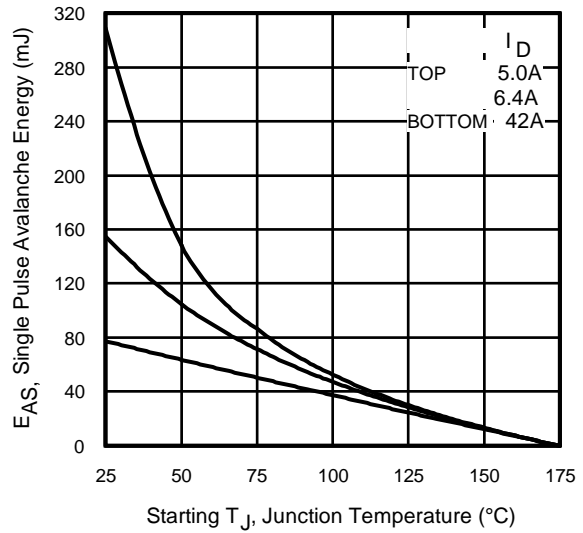

**Fig 12c.** Maximum Avalanche Energy Vs. Drain Current

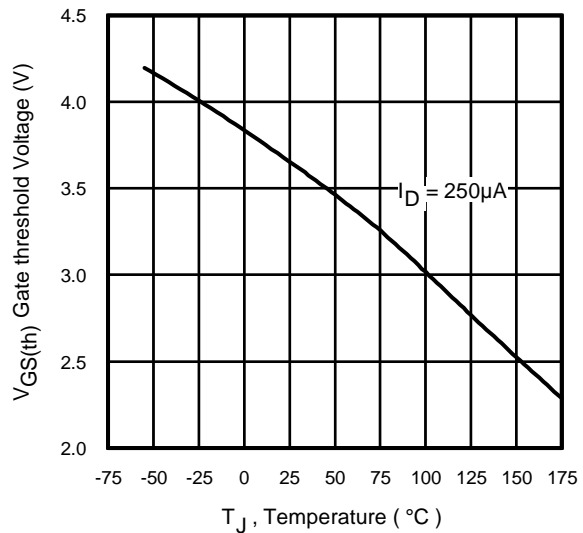

**Fig 14.** Threshold Voltage Vs. Temperature

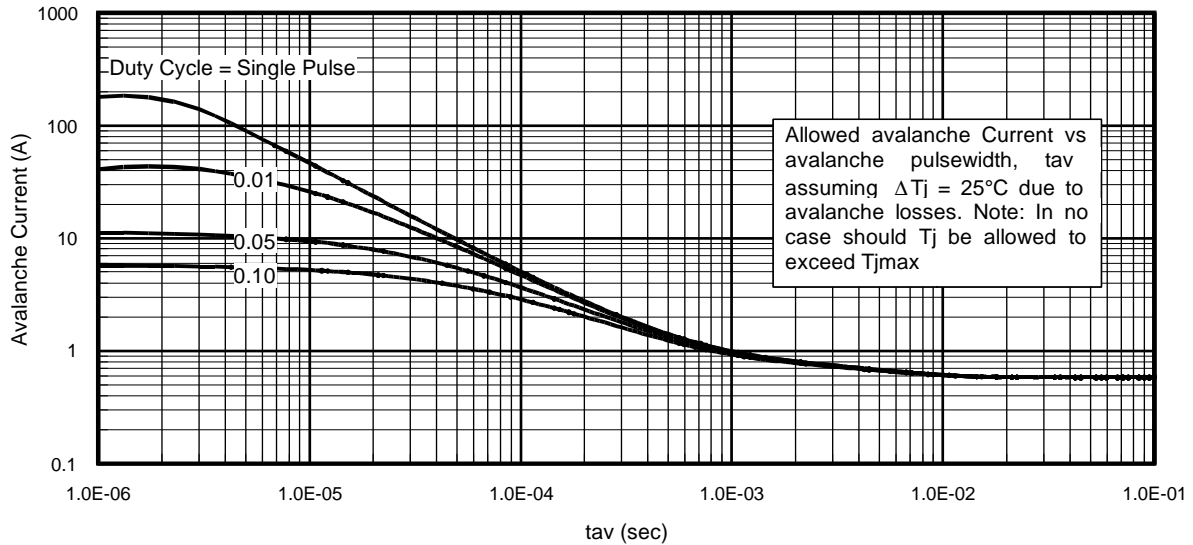

Fig 15. Typical Avalanche Current Vs.Pulsewidth

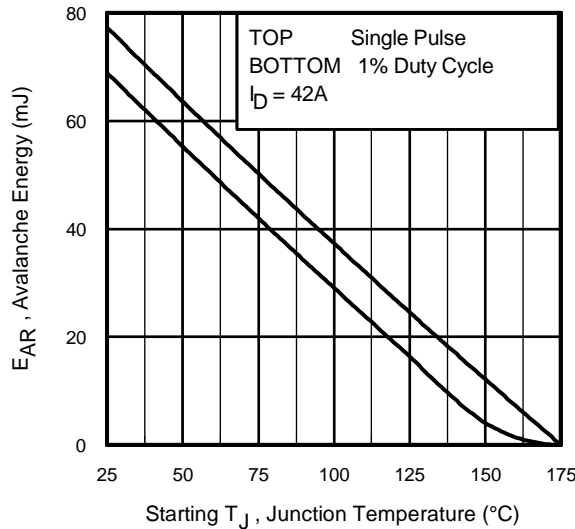

Fig 16. Maximum Avalanche Energy Vs. Temperature

**Notes on Repetitive Avalanche Curves , Figures 15, 16:**  
**(For further info, see AN-1005 at www.irf.com)**

1. Avalanche failures assumption:  
Purely a thermal phenomenon and failure occurs at a temperature far in excess of  $T_{jmax}$ . This is validated for every part type.
2. Safe operation in Avalanche is allowed as long as  $T_{jmax}$  is not exceeded.
3. Equation below based on circuit and waveforms shown in Figures 12a, 12b.
4.  $P_{D(ave)}$  = Average power dissipation per single avalanche pulse.
5.  $BV$  = Rated breakdown voltage (1.3 factor accounts for voltage increase during avalanche).
6.  $I_{av}$  = Allowable avalanche current.
7.  $\Delta T$  = Allowable rise in junction temperature, not to exceed  $T_{jmax}$  (assumed as 25°C in Figure 15, 16).  
 $t_{av}$  = Average time in avalanche.  
 $D$  = Duty cycle in avalanche =  $t_{av} \cdot f$   
 $Z_{thJC}(D, t_{av})$  = Transient thermal resistance, see figure 11)

$$P_{D(ave)} = 1/2 ( 1.3 \cdot BV \cdot I_{av} ) = \Delta T / Z_{thJC}$$

$$I_{av} = 2\Delta T / [1.3 \cdot BV \cdot Z_{th}]$$

$$E_{AS(AR)} = P_{D(ave)} \cdot t_{av}$$

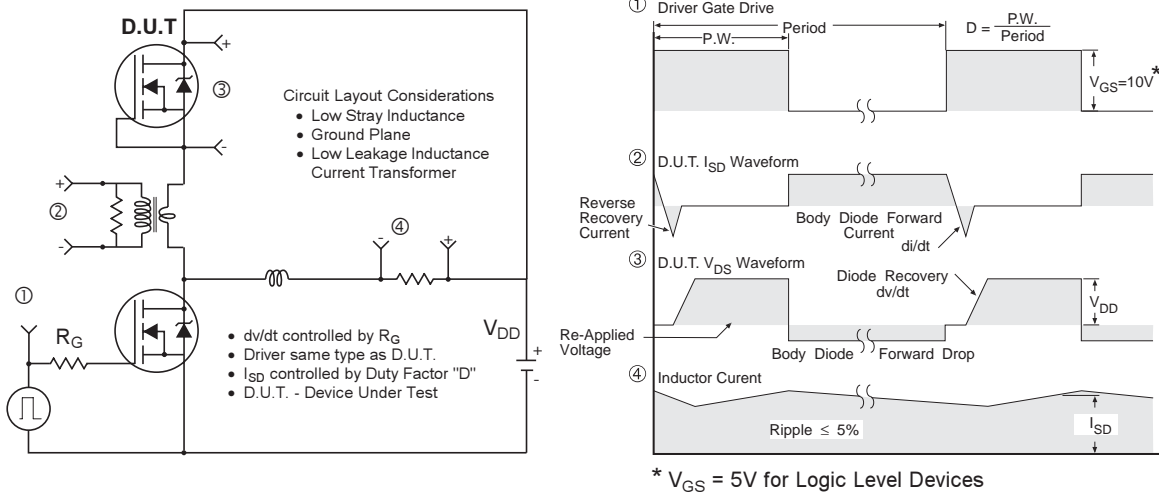

**Fig 17. Peak Diode Recovery  $dv/dt$  Test Circuit for N-Channel HEXFET® Power MOSFETs**

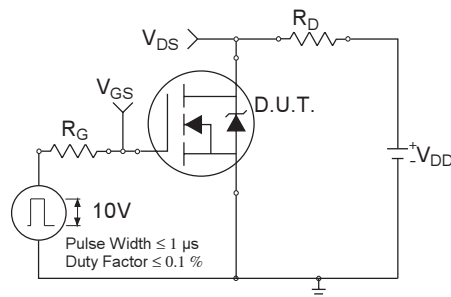

**Fig 18a. Switching Time Test Circuit**

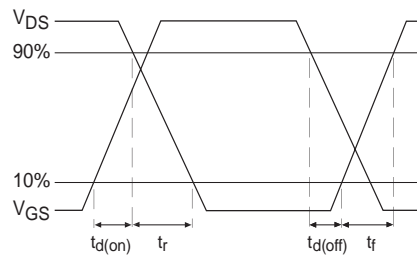

**Fig 18b. Switching Time Waveforms**

## D-Pak (TO-252AA) Package Outline

Dimensions are shown in millimeters (inches)

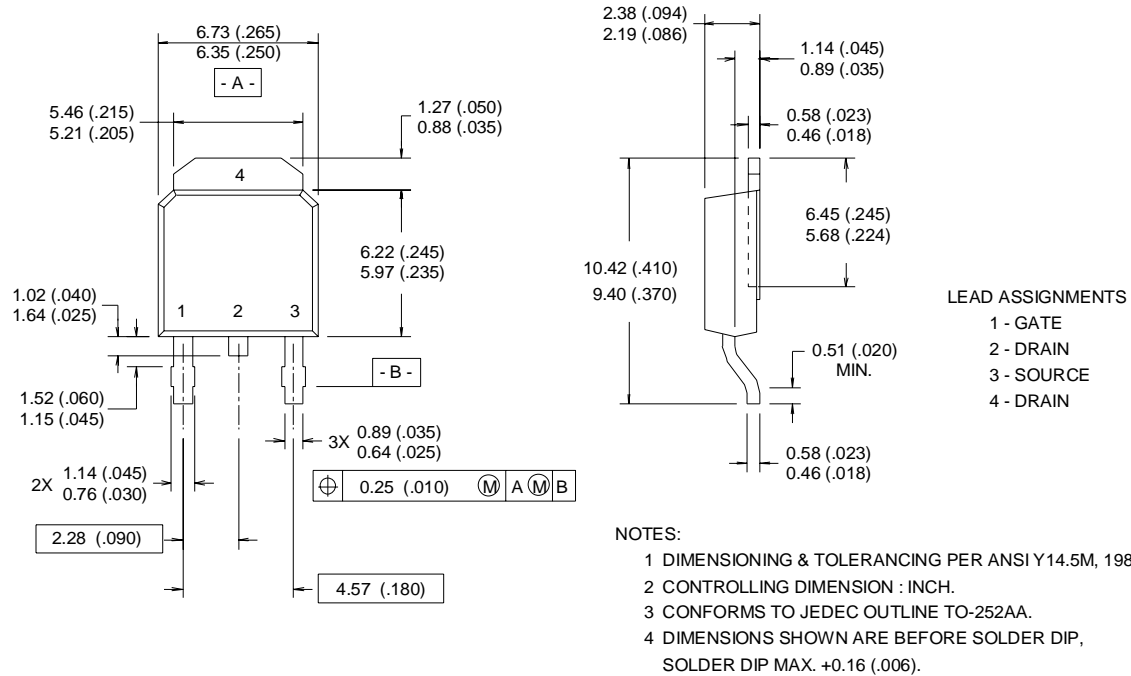

## D-Pak (TO-252AA) Part Marking Information

Notes: This part marking information applies to devices produced before 02/26/2001

EXAMPLE: THIS IS AN IRFR120  
 WITH ASSEMBLY  
 LOT CODE 9U1P

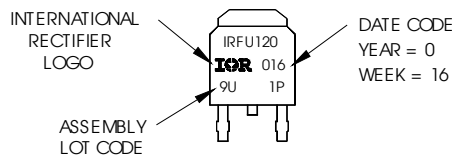

Notes: This part marking information applies to devices produced after 02/26/2001

EXAMPLE: THIS IS AN IRFR120  
 WITH ASSEMBLY  
 LOT CODE 1234  
 ASSEMBLED ON WW 16, 1999  
 IN THE ASSEMBLY LINE "A"

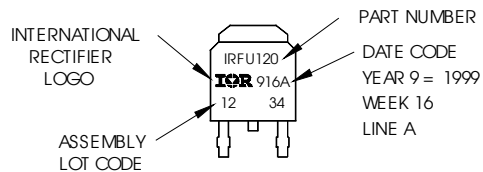

# IRFR/U3504Z

## I-Pak (TO-251AA) Package Outline

Dimensions are shown in millimeters (inches)

International  
**IR** Rectifier

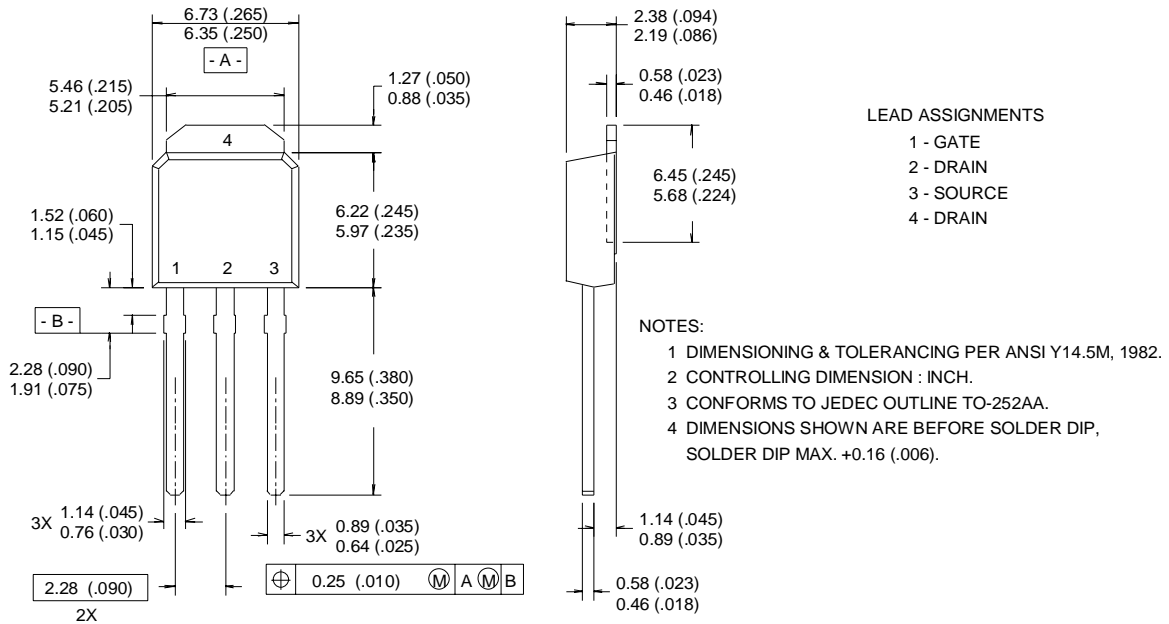

## I-Pak (TO-251AA) Part Marking Information

Notes: This part marking information applies to devices produced before 02/26/2001

EXAMPLE: THIS IS AN IRFR120  
WITH ASSEMBLY  
LOT CODE 9U1P

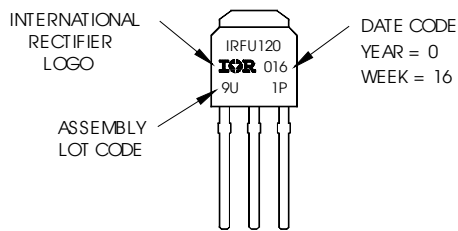

Notes: This part marking information applies to devices produced after 02/26/2001

EXAMPLE: THIS IS AN IRFR120  
WITH ASSEMBLY  
LOT CODE 5678  
ASSEMBLED ON WW 19, 1999  
IN THE ASSEMBLY LINE "A"

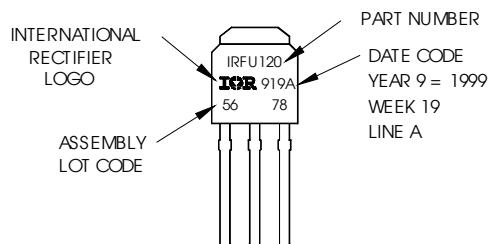

## D-Pak (TO-252AA) Tape & Reel Information

Dimensions are shown in millimeters (inches)

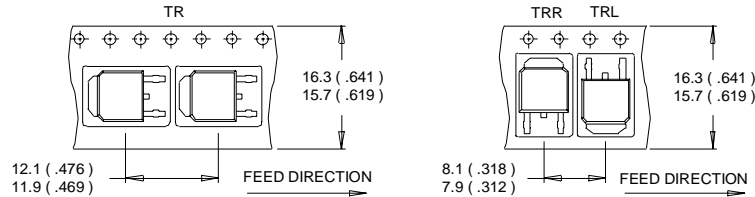

- NOTES :
1. CONTROLLING DIMENSION : MILLIMETER.
  2. ALL DIMENSIONS ARE SHOWN IN MILLIMETERS ( INCHES ).
  3. OUTLINE CONFORMS TO EIA-481 & EIA-541.

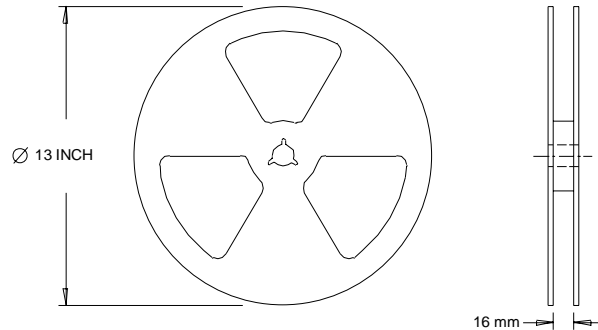

- NOTES :
1. OUTLINE CONFORMS TO EIA-481.

### Notes:

- ① Repetitive rating; pulse width limited by max. junction temperature. (See fig. 11).
- ② Limited by  $T_{Jmax}$ ; starting  $T_J = 25^\circ\text{C}$ ,  $L = 0.09\text{mH}$ ,  $R_G = 25\Omega$ ,  $I_{AS} = 42\text{A}$ ,  $V_{GS} = 10\text{V}$ . Part not recommended for use above this value.
- ③ Pulse width  $\leq 1.0\text{ms}$ ; duty cycle  $\leq 2\%$ .
- ④  $C_{OSS}$  eff. is a fixed capacitance that gives the same charging time as  $C_{OSS}$  while  $V_{DS}$  is rising from 0 to 80%  $V_{DSS}$ .
- ⑤ Limited by  $T_{Jmax}$ , see Fig.12a, 12b, 15, 16 for typical repetitive avalanche performance.
- ⑥ This value determined from sample failure population. 100% tested to this value in production.
- ⑦ When mounted on 1" square PCB (FR-4 or G-10 Material). For recommended footprint and soldering techniques refer to application note #AN-994

Data and specifications subject to change without notice.  
 This product has been designed and qualified for the Automotive [Q101] market.  
 Qualification Standards can be found on IR's Web site.



LittleDiode supplies new, hard to find or obsolete electronic components and semiconductors all over the world.

With over two million different components listed you are sure to find the part you need.

Feel free to visit us today at our online store:

[LittleDiode.com](http://LittleDiode.com)

Looking forward to providing you with the best possible service.