

**RADIATION HARDENED
 POWER MOSFET
 THRU-HOLE (TO-254AA)**

**IRHM57064
 60V, N-CHANNEL
 R5 TECHNOLOGY**

Product Summary

Part Number	Radiation Level	RDS(on)	ID
IRHM57064	100K Rads (Si)	0.012Ω	35A*
IRHM53064	300K Rads (Si)	0.012Ω	35A*
IRHM54064	600K Rads (Si)	0.012Ω	35A*
IRHM58064	1000K Rads (Si)	0.013Ω	35A*



International Rectifier's R5™ technology provides high performance power MOSFETs for space applications. These devices have been characterized for Single Event Effects (SEE) with useful performance up to an LET of 80 (MeV/(mg/cm²)). The combination of low RDS(on) and low gate charge reduces the power losses in switching applications such as DC to DC converters and motor control. These devices retain all of the well established advantages of MOSFETs such as voltage control, fast switching, ease of paralleling and temperature stability of electrical parameters.

Features:

- Single Event Effect (SEE) Hardened
- Neutron Tolerant
- Identical Pre- and Post-Electrical Test Conditions
- Repetitive Avalanche Ratings
- Dynamic dv/dt Ratings
- Simple Drive Requirements
- Ease of Paralleling
- Hermetically Sealed
- Electrically Isolated
- Ceramic Eyelets
- Light Weight

Absolute Maximum Ratings

Pre-Irradiation

	Parameter		Units
ID @ VGS = 12V, TC = 25°C	Continuous Drain Current	35*	A
ID @ VGS = 12V, TC = 100°C	Continuous Drain Current	35*	
IDM	Pulsed Drain Current ①	140	
PD @ TC = 25°C	Max. Power Dissipation	250	W
	Linear Derating Factor	2.0	W/°C
VGS	Gate-to-Source Voltage	±20	V
EAS	Single Pulse Avalanche Energy ②	500	mJ
IAR	Avalanche Current ①	35	A
EAR	Repetitive Avalanche Energy ①	25	mJ
dv/dt	Peak Diode Recovery dv/dt ③	4.8	V/ns
TJ	Operating Junction	-55 to 150	°C
TSTG	Storage Temperature Range		
	Lead Temperature	300 (0.063 in. (1.6 mm from case for 10s)	
	Weight	9.3 (Typical)	g

* Current is limited by internal wire diameter
 For footnotes refer to the last page

Electrical Characteristics @ T_J = 25°C (Unless Otherwise Specified)

	Parameter	Min	Typ	Max	Units	Test Conditions
BV _{DSS}	Drain-to-Source Breakdown Voltage	60	—	—	V	V _{GS} = 0V, I _D = 1.0mA
ΔBV _{DSS} /ΔT _J	Temperature Coefficient of Breakdown Voltage	—	0.063	—	V/°C	Reference to 25°C, I _D = 1.0mA
R _{DS(on)}	Static Drain-to-Source On-State Resistance	—	—	0.012	Ω	V _{GS} = 12V, I _D = 35A ④
V _{GS(th)}	Gate Threshold Voltage	2.0	—	4.0	V	V _{DS} = V _{GS} , I _D = 1.0mA
g _{fs}	Forward Transconductance	42	—	—	S (Ω)	V _{DS} > 15V, I _{DS} = 35A ④
I _{DSS}	Zero Gate Voltage Drain Current	—	—	10	μA	V _{DS} = 48V, V _{GS} = 0V
		—	—	25		V _{DS} = 48V, V _{GS} = 0V, T _J = 125°C
I _{GSS}	Gate-to-Source Leakage Forward	—	—	100	nA	V _{GS} = 20V
I _{GSS}	Gate-to-Source Leakage Reverse	—	—	-100		V _{GS} = -20V
Q _g	Total Gate Charge	—	—	160	nC	V _{GS} = 12V, I _D = 35A
Q _{gs}	Gate-to-Source Charge	—	—	55		V _{DS} = 50V
Q _{gd}	Gate-to-Drain ('Miller') Charge	—	—	65		
t _{d(on)}	Turn-On Delay Time	—	—	35	ns	V _{DD} = 30V, I _D = 35A V _{GS} = 12V, R _G = 2.35Ω
t _r	Rise Time	—	—	125		
t _{d(off)}	Turn-Off Delay Time	—	—	75		
t _f	Fall Time	—	—	50		
LS + LD	Total Inductance	—	6.8	—	nH	Measured from Drain lead (6mm /0.25in. from package) to Source lead (6mm /0.25in. from package) with Source wires internally bonded from Source Pin to Drain Pad
C _{iss}	Input Capacitance	—	6300	—	pF	V _{GS} = 0V, V _{DS} = 25V f = 1.0MHz
C _{oss}	Output Capacitance	—	2300	—		
C _{rss}	Reverse Transfer Capacitance	—	70	—		

Source-Drain Diode Ratings and Characteristics

	Parameter	Min	Typ	Max	Units	Test Conditions
I _S	Continuous Source Current (Body Diode)	—	—	35*	A	
I _{SM}	Pulse Source Current (Body Diode) ①	—	—	140		
V _{SD}	Diode Forward Voltage	—	—	1.2	V	T _J = 25°C, I _S = 35A, V _{GS} = 0V ④
t _{rr}	Reverse Recovery Time	—	—	200	ns	T _J = 25°C, I _F = 35A, di/dt ≤ 100A/μs
Q _{RR}	Reverse Recovery Charge	—	—	818	nC	V _{DD} ≤ 25V ④
t _{on}	Forward Turn-On Time	Intrinsic turn-on time is negligible. Turn-on speed is substantially controlled by L _S + L _D .				

* Current is limited by internal wire diameter

Thermal Resistance

	Parameter	Min	Typ	Max	Units	Test Conditions
R _{thJC}	Junction-to-Case	—	—	0.50	°C/W	
R _{thCS}	Case-to-Sink	—	0.21	—		
R _{thJA}	Junction-to-Ambient	—	—	48		Typical socket mount

Note: Corresponding Spice and Saber models are available on the G&S Website.

For footnotes refer to the last page

Radiation Characteristics

IRHM57064

International Rectifier Radiation Hardened MOSFETs are tested to verify their radiation hardness capability. The hardness assurance program at International Rectifier is comprised of two radiation environments. Every manufacturing lot is tested for total ionizing dose (per notes 5 and 6) using the TO-3 package. Both pre- and post-irradiation performance are tested and specified using the same drive circuitry and test conditions in order to provide a direct comparison.

Table 1. Electrical Characteristics @ Tj = 25°C, Post Total Dose Irradiation ⑤⑥

	Parameter	Up to 600K Rads(Si) ¹		1000K Rads (Si) ²		Units	Test Conditions
		Min	Max	Min	Max		
BV _{DSS}	Drain-to-Source Breakdown Voltage	60	—	60	—	V	V _{GS} = 0V, I _D = 1.0mA
V _{GS(th)}	Gate Threshold Voltage	2.0	4.0	1.5	4.0		V _{GS} = V _{DS} , I _D = 1.0mA
I _{GSS}	Gate-to-Source Leakage Forward	—	100	—	100	nA	V _{GS} = 20V
I _{GSS}	Gate-to-Source Leakage Reverse	—	-100	—	-100		V _{GS} = -20 V
I _{DSS}	Zero Gate Voltage Drain Current	—	10	—	25	μA	V _{DS} = 48V, V _{GS} = 0V
R _{DS(on)}	Static Drain-to-Source ④ On-State Resistance (TO-3)	—	0.0061	—	0.0071	Ω	V _{GS} = 12V, I _D = 35A
R _{DS(on)}	Static Drain-to-Source ④ On-State Resistance (TO-254)	—	0.012	—	0.013	Ω	V _{GS} = 12V, I _D = 35A
V _{SD}	Diode Forward Voltage ④	—	1.2	—	1.2	V	V _{GS} = 0V, I _S = 35A

1. Part numbers IRHM57064, IRHM53064 and IRHM54064

2. Part number IRHM58064

International Rectifier radiation hardened MOSFETs have been characterized in heavy ion environment for Single Event Effects (SEE). Single Event Effects characterization is illustrated in Fig. a and Table 2.

Table 2. Single Event Effect Safe Operating Area

Ion	LET MeV/(mg/cm ²)	Energy (MeV)	Range (μm)	V _{DS} (V)				
				@ V _{GS} =0V	@ V _{GS} =-5V	@ V _{GS} =-10V	@ V _{GS} =-15V	@ V _{GS} =-20V
Kr	39.2	300	37.4	60	60	60	52	34
Xe	63.3	300	29.2	46	46	35	25	15
Au	86.6	2068	106	35	35	27	20	14

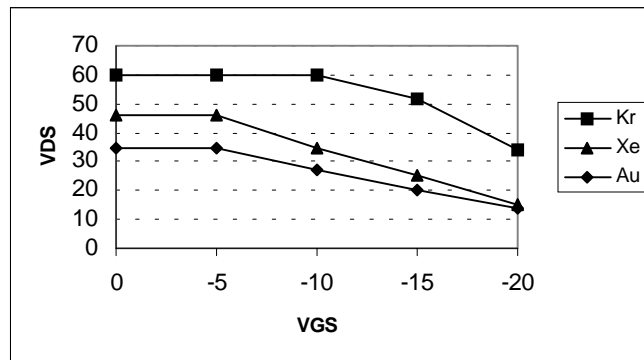

Fig a. Single Event Effect, Safe Operating Area

For footnotes refer to the last page

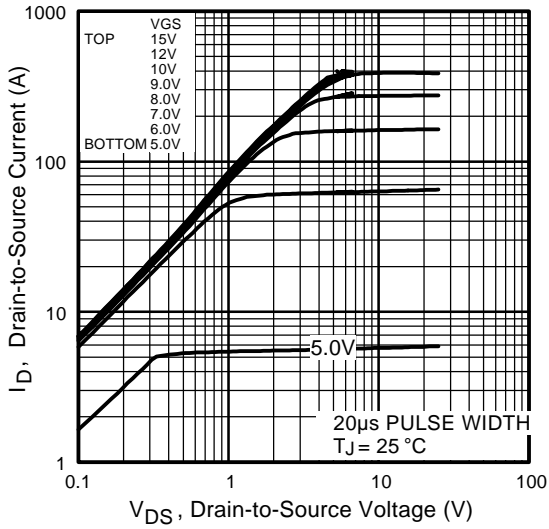

Fig 1. Typical Output Characteristics

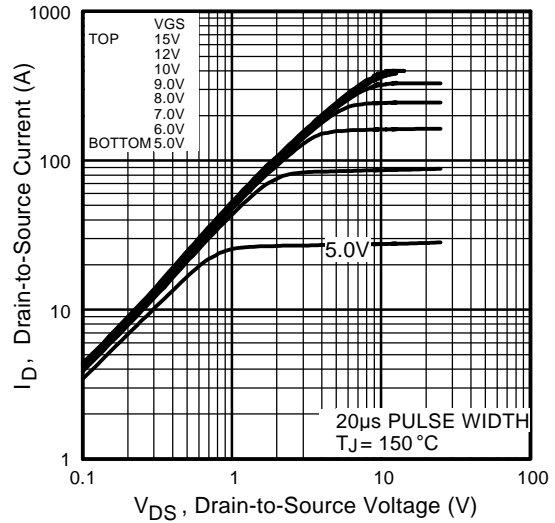

Fig 2. Typical Output Characteristics

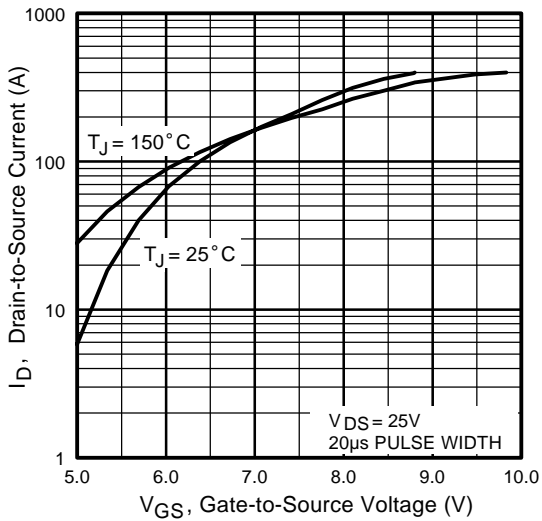

Fig 3. Typical Transfer Characteristics

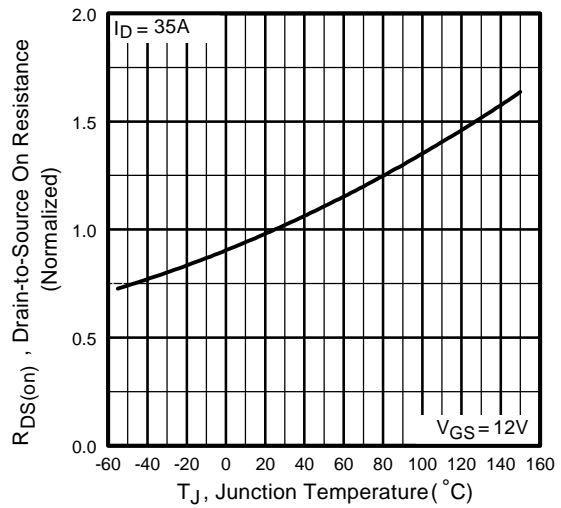

Fig 4. Normalized On-Resistance Vs. Temperature

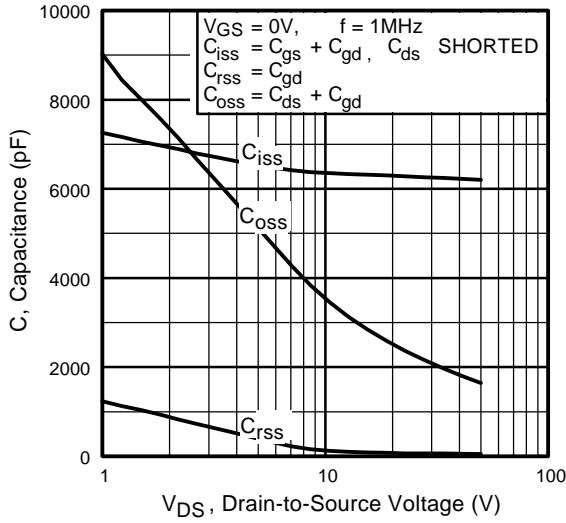

Fig 5. Typical Capacitance Vs. Drain-to-Source Voltage

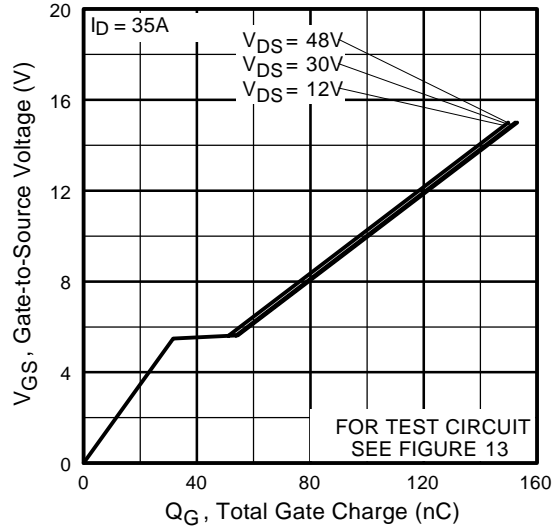

Fig 6. Typical Gate Charge Vs. Gate-to-Source Voltage

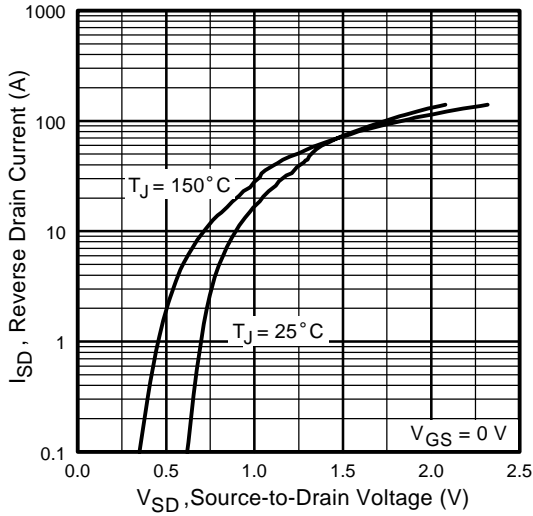

Fig 7. Typical Source-Drain Diode Forward Voltage

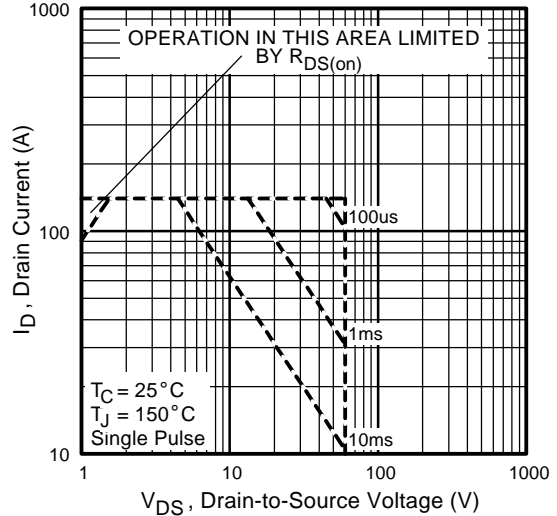

Fig 8. Maximum Safe Operating Area

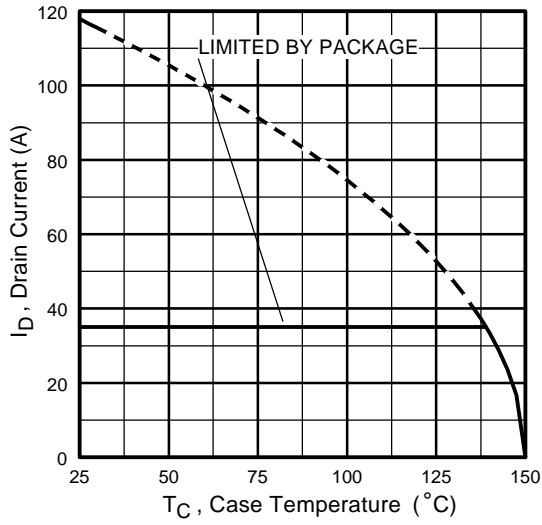

Fig 9. Maximum Drain Current Vs. Case Temperature

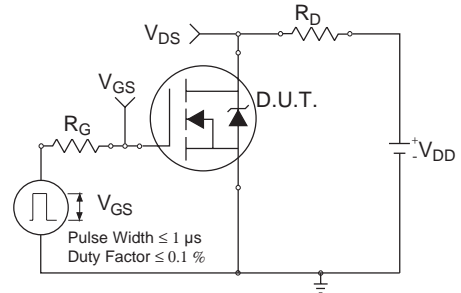

Fig 10a. Switching Time Test Circuit

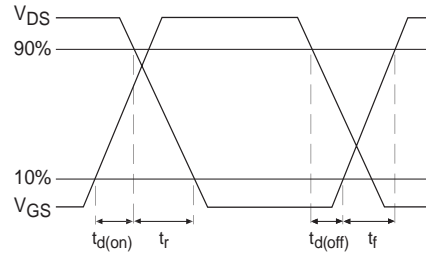

Fig 10b. Switching Time Waveforms

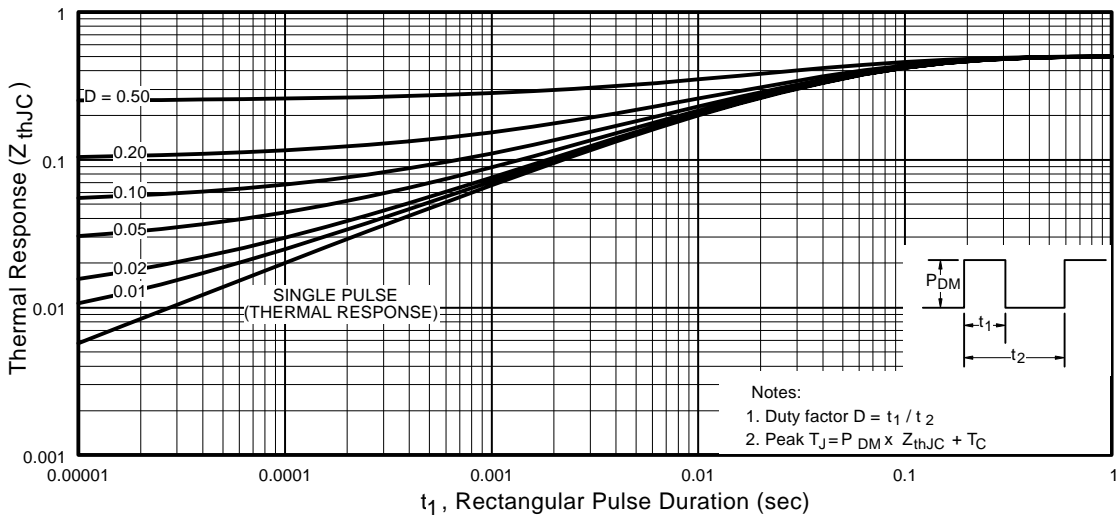

Fig 11. Maximum Effective Transient Thermal Impedance, Junction-to-Case

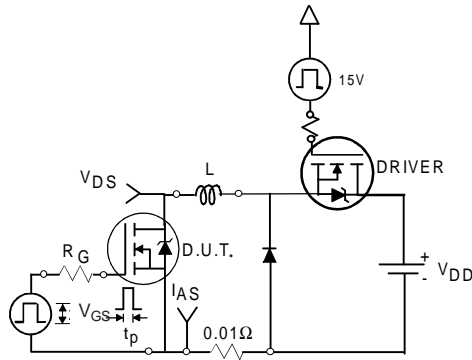

Fig 12a. Unclamped Inductive Test Circuit

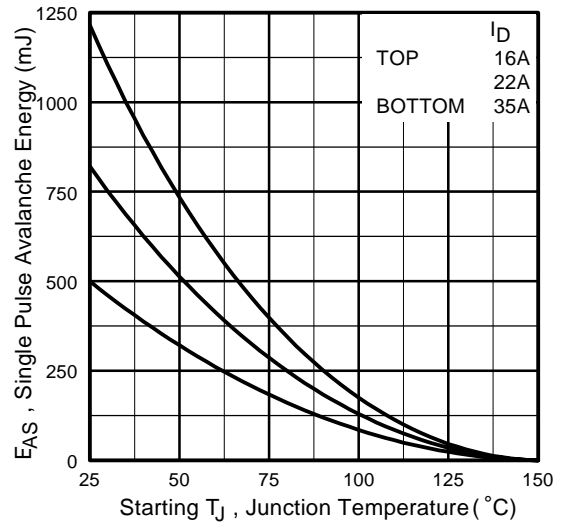

Fig 12c. Maximum Avalanche Energy Vs. Drain Current

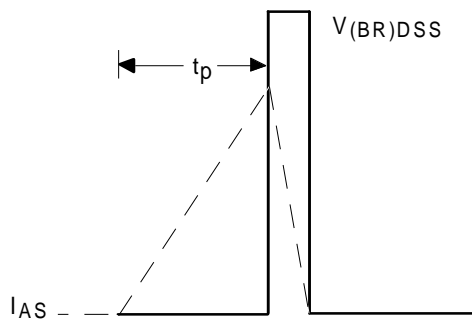

Fig 12b. Unclamped Inductive Waveforms

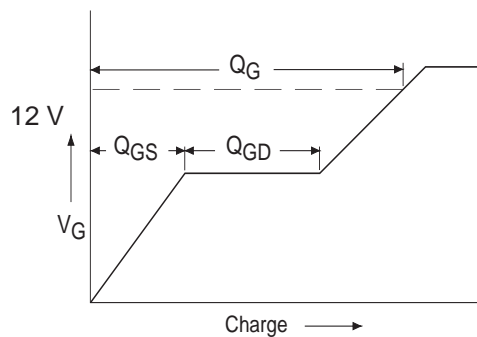

Fig 13a. Basic Gate Charge Waveform

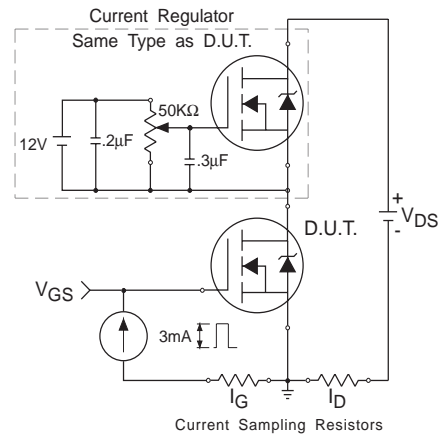
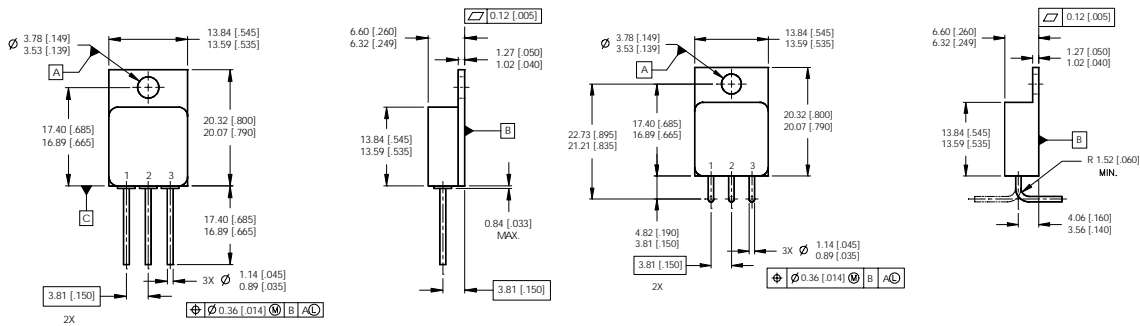

Fig 13b. Gate Charge Test Circuit

Footnotes:

- ① Repetitive Rating; Pulse width limited by maximum junction temperature.
- ② $V_{DD} = 25V$, starting $T_J = 25^\circ C$, $L = 0.8\text{ mH}$
Peak $I_L = 35A$, $V_{GS} = 12V$
- ③ $I_{SD} \leq 35A$, $di/dt \leq 265A/\mu s$,
 $V_{DD} \leq 60V$, $T_J \leq 150^\circ C$
- ④ Pulse width $\leq 300\ \mu s$; Duty Cycle $\leq 2\%$
- ⑤ **Total Dose Irradiation with V_{GS} Bias.**
12 volt V_{GS} applied and $V_{DS} = 0$ during irradiation per MIL-STD-750, method 1019, condition A.
- ⑥ **Total Dose Irradiation with V_{DS} Bias.**
48 volt V_{DS} applied and $V_{GS} = 0$ during irradiation per MIL-STD-750, method 1019, condition A.

Case Outline and Dimensions — TO-254AA



- NOTES:
- DIMENSIONING & TOLERANCING PER ASME Y14.5M-1994.
 - ALL DIMENSIONS ARE SHOWN IN MILLIMETERS [INCHES].
 - CONTROLLING DIMENSION: INCH.
 - CONFORMS TO JEDEC OUTLINE TO-254AA.

- PIN ASSIGNMENTS
- 1 = DRAIN
 - 2 = SOURCE
 - 3 = GATE

CAUTION

BERYLLIA WARNING PER MIL-PRF-19500

Packages containing beryllia shall not be ground, sandblasted, machined, or have other operations performed on them which will produce beryllia or beryllium dust. Furthermore, beryllium oxide packages shall not be placed in acids that will produce fumes containing beryllium.



IR WORLD HEADQUARTERS: 233 Kansas St., El Segundo, California 90245, USA Tel: (310) 252-7105
TAC Fax: (310) 252-7903

Visit us at www.irf.com for sales contact information.
Data and specifications subject to change without notice. 08/02



LittleDiode supplies new, hard to find or obsolete electronic components and semiconductors all over the world.

With over two million different components listed you are sure to find the part you need.

Feel free to visit us today at our online store:

LittleDiode.com

Looking forward to providing you with the best possible service.