

**HEXFET® POWER MOSFET
 THRU-HOLE (TO-257AA)**

**IRF5Y31N20
 200V, N-CHANNEL**

Product Summary

Part Number	BV _{DSS}	R _{DS(on)}	I _D
IRF5Y31N20	200V	0.092Ω	18A*

Fifth Generation HEXFET® power MOSFETs from International Rectifier utilize advanced processing techniques to achieve the lowest possible on-resistance per silicon unit area. This benefit, combined with the fast switching speed and ruggedized device design that HEXFET power MOSFETs are well known for, provides the designer with an extremely efficient device for use in a wide variety of applications.

These devices are well-suited for applications such as switching power supplies, motor controls, inverters, choppers, audio amplifiers and high-energy pulse circuits.

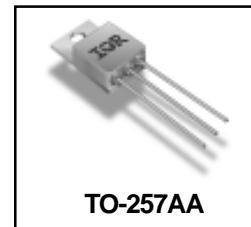

TO-257AA

Features:

- Low R_{DS(on)}
- Avalanche Energy Ratings
- Dynamic dv/dt Rating
- Simple Drive Requirements
- Ease of Paralleling
- Hermetically Sealed
- Light Weight

Absolute Maximum Ratings

	Parameter		Units
I _D @ V _{GS} = 10V, T _C = 25°C	Continuous Drain Current	18*	A
I _D @ V _{GS} = 10V, T _C = 100°C	Continuous Drain Current	14	
I _{DM}	Pulsed Drain Current ①	72	
P _D @ T _C = 25°C	Max. Power Dissipation	100	W
	Linear Derating Factor	0.8	W/°C
V _{GS}	Gate-to-Source Voltage	±20	V
EAS	Single Pulse Avalanche Energy ②	170	mJ
I _{AR}	Avalanche Current ①	18	A
EAR	Repetitive Avalanche Energy ①	10	mJ
dv/dt	Peak Diode Recovery dv/dt ③	1.7	V/ns
T _J	Operating Junction	-55 to 150	°C
T _{STG}	Storage Temperature Range		
	Lead Temperature	300 (0.063in./1.6mm from case for 10s)	
	Weight	4.3 (Typical)	g

* Current is limited by package

For footnotes refer to the last page

Electrical Characteristics @ T_j = 25°C (Unless Otherwise Specified)

	Parameter	Min	Typ	Max	Units	Test Conditions
BV _{DSS}	Drain-to-Source Breakdown Voltage	200	—	—	V	V _{GS} = 0V, I _D = 250μA
ΔBV _{DSS} /ΔT _J	Temperature Coefficient of Breakdown Voltage	—	0.27	—	V/°C	Reference to 25°C, I _D = 1.0mA
R _{DSON}	Static Drain-to-Source On-State Resistance	—	—	0.092	Ω	V _{GS} = 10V, I _D = 14A ④
V _{GS(th)}	Gate Threshold Voltage	3.0	—	5.5	V	V _{DS} = V _{GS} , I _D = 250μA
g _{fs}	Forward Transconductance	14	—	—	S (r)	V _{DS} = 15V, I _{DS} = 14A ④
I _{DSS}	Zero Gate Voltage Drain Current	—	—	25	μA	V _{DS} = 200V, V _{GS} = 0V
		—	—	250		V _{DS} = 160V, V _{GS} = 0V, T _J = 125°C
I _{GSS}	Gate-to-Source Leakage Forward	—	—	100	nA	V _{GS} = 20V
I _{GSS}	Gate-to-Source Leakage Reverse	—	—	-100		V _{GS} = -20V
Q _g	Total Gate Charge	—	—	100	nC	V _{GS} = 10V, I _D = 18A
Q _{gs}	Gate-to-Source Charge	—	—	32		V _{DS} = 160V
Q _{gd}	Gate-to-Drain ('Miller') Charge	—	—	46		
t _{d(on)}	Turn-On Delay Time	—	—	30	ns	V _{DD} = 100V, I _D = 18A, V _{GS} = 10V, R _G = 2.5Ω
t _r	Rise Time	—	—	148		
t _{d(off)}	Turn-Off Delay Time	—	—	50		
t _f	Fall Time	—	—	27		
L _S + L _D	Total Inductance	—	6.8	—	nH	Measured from drain lead (6mm / 0.25in. from package) to source lead (6mm/0.25in. from package)
C _{iss}	Input Capacitance	—	2480	—	pF	V _{GS} = 0V, V _{DS} = 25V f = 1.0MHz
C _{OSS}	Output Capacitance	—	370	—		
C _{rSS}	Reverse Transfer Capacitance	—	73	—		

Source-Drain Diode Ratings and Characteristics

	Parameter	Min	Typ	Max	Units	Test Conditions
I _S	Continuous Source Current (Body Diode)	—	—	18*	A	T _j = 25°C, I _S = 18A, V _{GS} = 0V ④
I _{SM}	Pulse Source Current (Body Diode) ①	—	—	72		
V _{SD}	Diode Forward Voltage	—	—	1.3	V	T _j = 25°C, I _F = 18A, di/dt ≤ 100A/μs
t _{rr}	Reverse Recovery Time	—	—	300	ns	V _{DD} ≤ 25V ④
Q _{RR}	Reverse Recovery Charge	—	—	2.3	μC	
t _{on}	Forward Turn-On Time	Intrinsic turn-on time is negligible. Turn-on speed is substantially controlled by L _S + L _D .				

* Current is limited by package

Thermal Resistance

	Parameter	Min	Typ	Max	Units	Test Conditions
R _{thJC}	Junction-to-Case	—	—	1.25	°C/W	

Note: Corresponding Spice and Saber models are available on the G&S Website.

For footnotes refer to the last page

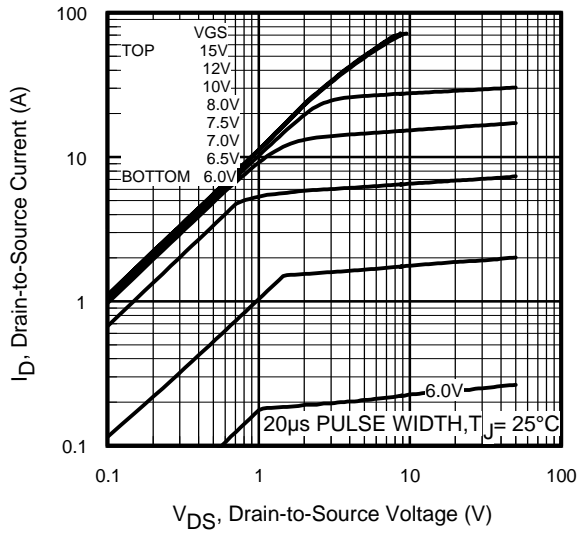

Fig 1. Typical Output Characteristics

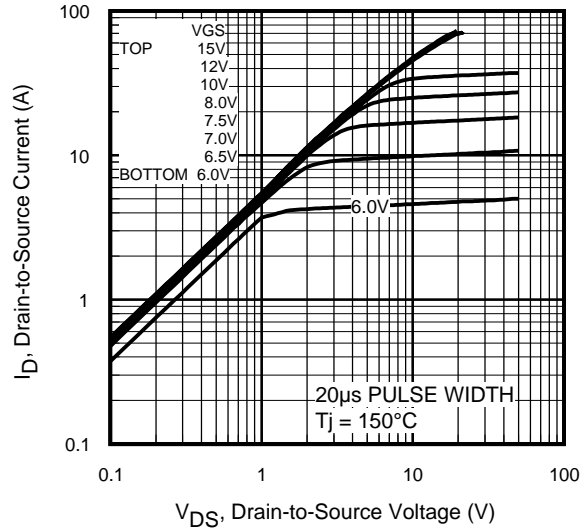

Fig 2. Typical Output Characteristics

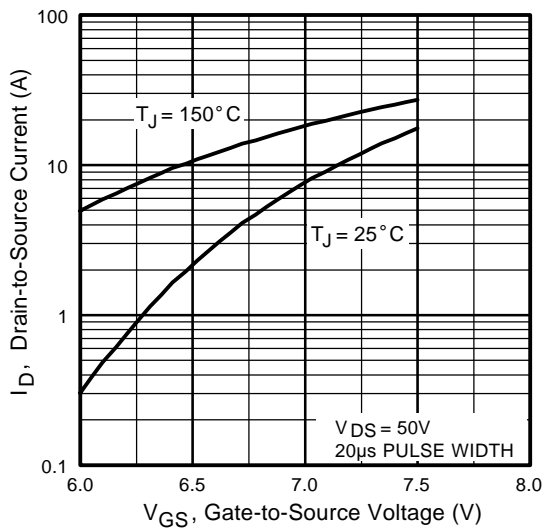

Fig 3. Typical Transfer Characteristics

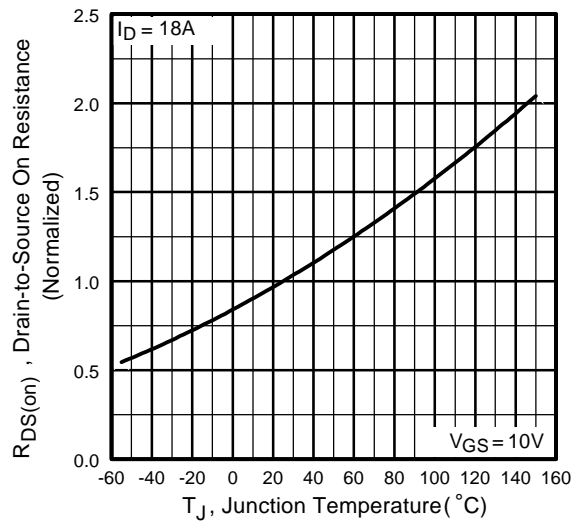

Fig 4. Normalized On-Resistance Vs. Temperature

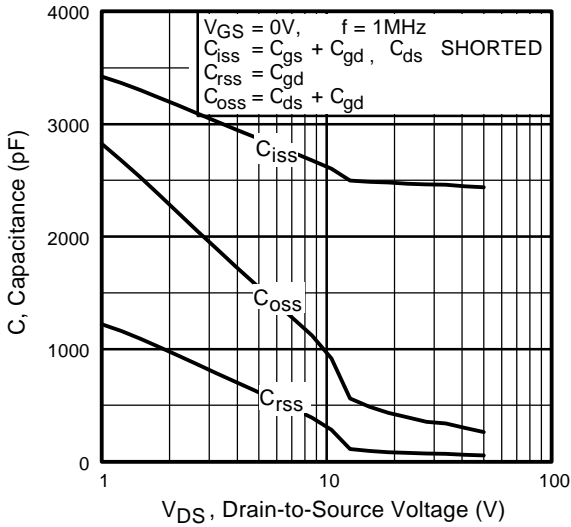

Fig 5. Typical Capacitance Vs. Drain-to-Source Voltage

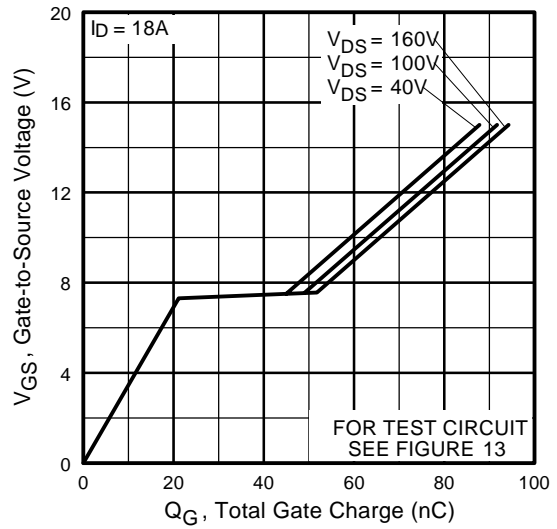

Fig 6. Typical Gate Charge Vs. Gate-to-Source Voltage

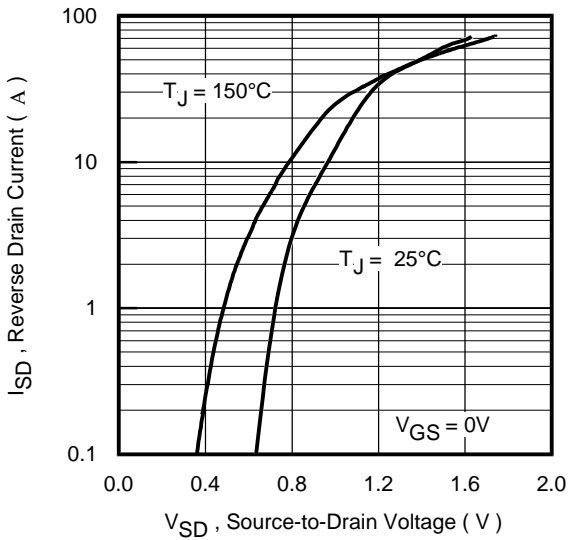

Fig 7. Typical Source-Drain Diode Forward Voltage

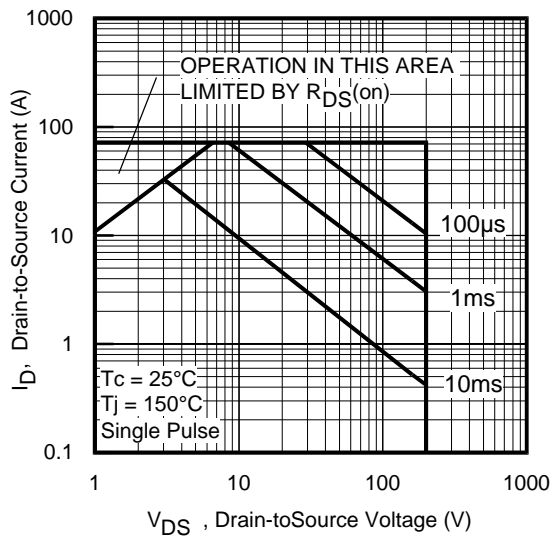

Fig 8. Maximum Safe Operating Area

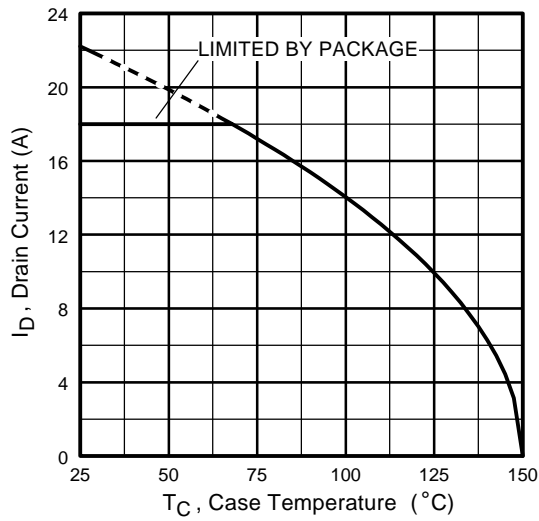

Fig 9. Maximum Drain Current Vs. Case Temperature

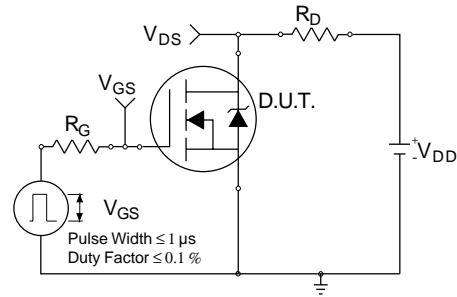

Fig 10a. Switching Time Test Circuit

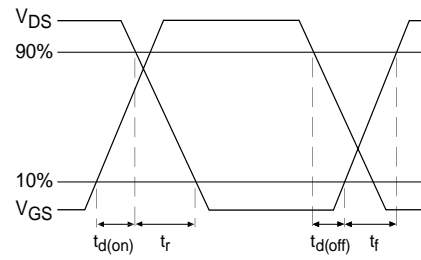

Fig 10b. Switching Time Waveforms

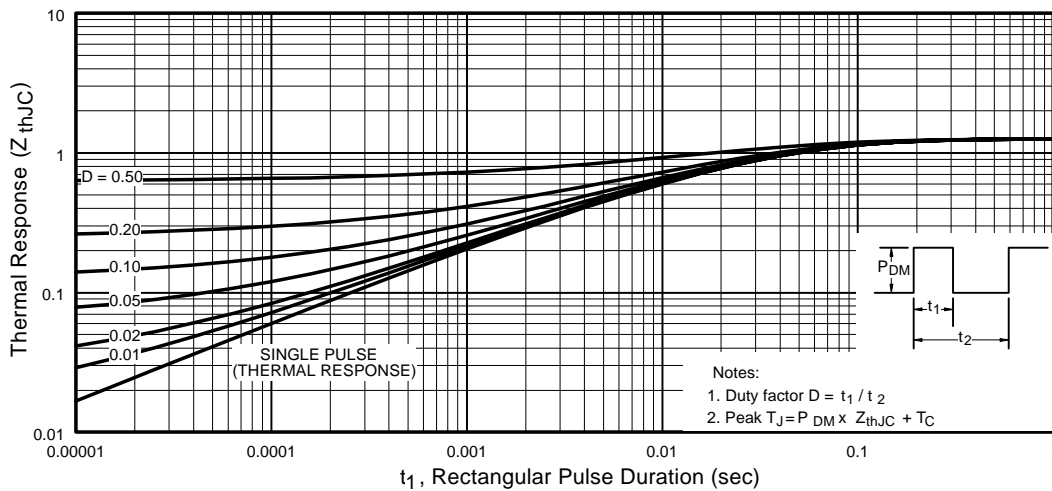

Fig 11. Maximum Effective Transient Thermal Impedance, Junction-to-Case

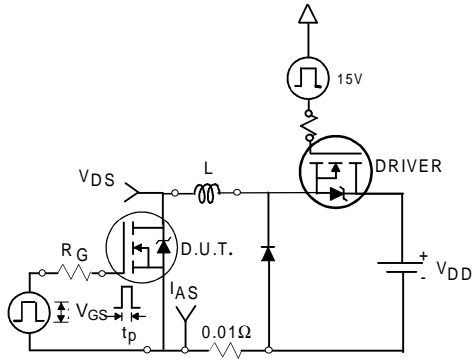

Fig 12a. Unclamped Inductive Test Circuit

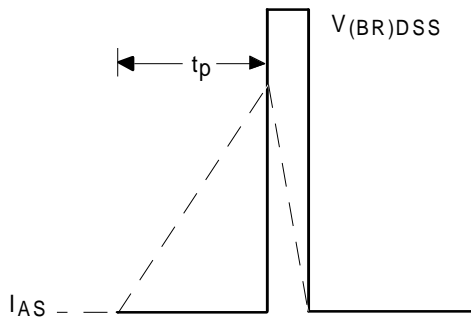

Fig 12b. Unclamped Inductive Waveforms

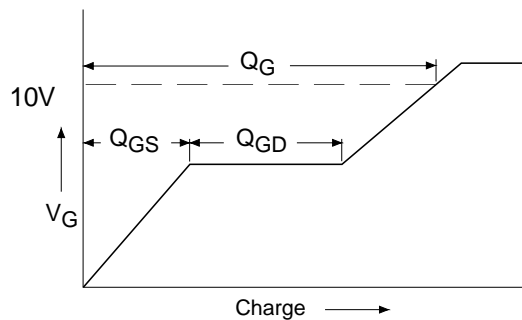

Fig 13a. Basic Gate Charge Waveform

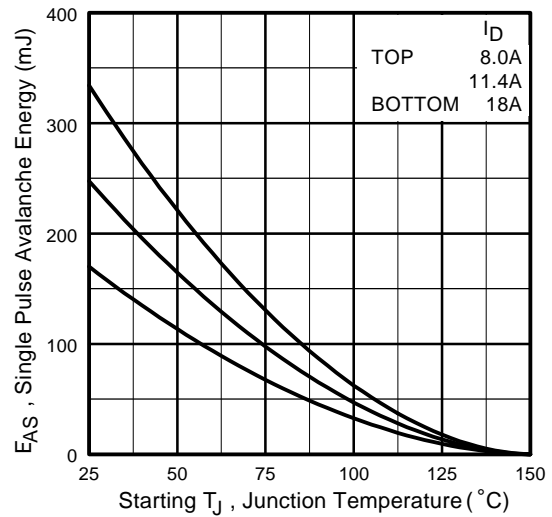

Fig 12c. Maximum Avalanche Energy Vs. Drain Current

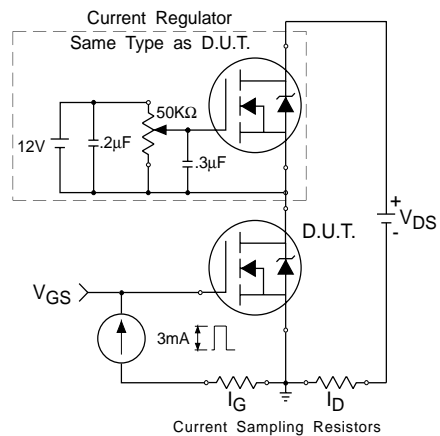
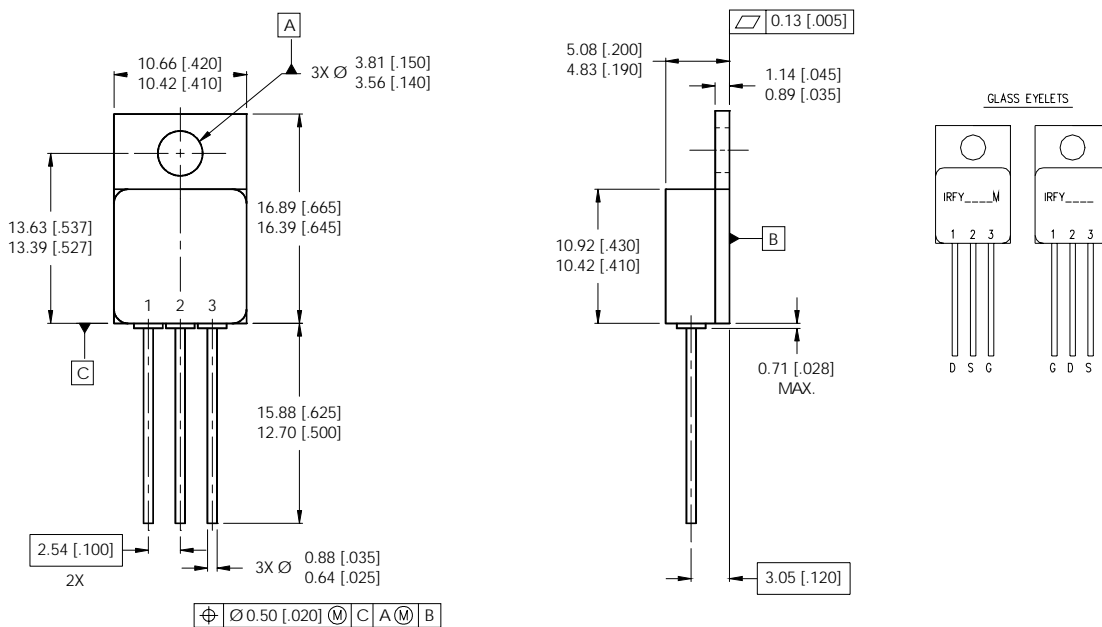

Fig 13b. Gate Charge Test Circuit

Footnotes:

- ① Repetitive Rating; Pulse width limited by maximum junction temperature.
- ② $V_{DD} = 25\text{ V}$, Starting $T_J = 25^\circ\text{C}$, $L = 1.0\text{ mH}$
Peak $I_{AS} = 18\text{ A}$, $V_{GS} = 10\text{ V}$, $R_G = 25\Omega$
- ③ $I_{SD} \leq 18\text{ A}$, $di/dt \leq 100\text{ A}/\mu\text{s}$,
 $V_{DD} \leq 200\text{ V}$, $T_J \leq 150^\circ\text{C}$
- ④ Pulse width $\leq 300\ \mu\text{s}$; Duty Cycle $\leq 2\%$

Case Outline and Dimensions — TO-257AA



NOTES:

- 1. DIMENSIONING & TOLERANCING PER ANSI Y14.5M-1994.
- 2. CONTROLLING DIMENSION: INCH.
- 3. DIMENSIONS ARE SHOWN IN MILLIMETERS [INCHES].
- 4. OUTLINE CONFORMS TO JEDEC OUTLINE TO-257AA.

PIN ASSIGNMENTS

- 1 = GATE
- 2 = DRAIN
- 3 = SOURCE



LittleDiode supplies new, hard to find or obsolete electronic components and semiconductors all over the world.

With over two million different components listed you are sure to find the part you need.

Feel free to visit us today at our online store:

LittleDiode.com

Looking forward to providing you with the best possible service.