

IRF7807VD2

FETKY™ MOSFET / SCHOTTKY DIODE

- Co-Pack N-channel HEXFET® Power MOSFET and Schottky Diode
- Ideal for Synchronous Rectifiers in DC-DC Converters Up to 5A Output
- Low Conduction Losses
- Low Switching Losses
- Low Vf Schottky Rectifier

Description

The FETKY™ family of Co-Pack HEXFET® MOSFETs and Schottky diodes offers the designer an innovative, board space saving solution for switching regulator and power management applications. HEXFET power MOSFETs utilize advanced processing techniques to achieve extremely low on-resistance per silicon area. Combining this technology with International Rectifier's low forward drop Schottky rectifiers results in an extremely efficient device suitable for use in a wide variety of portable electronics applications.

The SO-8 has been modified through a customized leadframe for enhanced thermal characteristics. The SO-8 package is designed for vapor phase, infrared or wave soldering techniques.

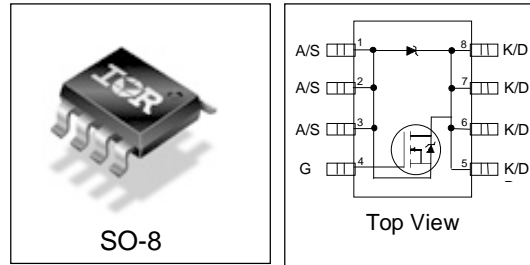

DEVICE CHARACTERISTICS^⑤

IRF7807VD2	
$R_{DS(on)}$	17mΩ
Q_G	9.5nC
Q_{sw}	3.4nC
Q_{oss}	12nC

Absolute Maximum Ratings

Parameter	Symbol	Max.	Units
Drain-Source Voltage	V_{DS}	30	V
Gate-Source Voltage	V_{GS}	±20	
Continuous Drain or Source Current ($V_{GS} \geq 4.5V$)	I_D	25°C	8.3
		70°C	6.6
Pulsed Drain Current ^①	I_{DM}	66	A
Power Dissipation ^③	P_D	25°C	2.5
		70°C	1.6
Schottky and Body Diode	$I_F (AV)$	25°C	3.7
Average Forward Current ^④		70°C	2.3
Junction & Storage Temperature Range	T_J, T_{STG}	-55 to 150	°C

Thermal Resistance

Parameter	Symbol	Max.	Units
Maximum Junction-to-Ambient ^③	$R_{\theta JA}$	50	°C/W
Maximum Junction-to-Lead	$R_{\theta JL}$	20	°C/W

Electrical Characteristics

Parameter		Min	Typ	Max	Units	Conditions
Drain-to-Source Breakdown Voltage	V_{DSS}	30	–	–	V	$V_{GS} = 0V, I_D = 250\mu A$
Static Drain-Source on Resistance	$R_{DS(on)}$		17	25	$m\Omega$	$V_{GS} = 4.5V, I_D = 7.0A^{\textcircled{2}}$
Gate Threshold Voltage	$V_{GS(th)}$	1.0			V	$V_{DS} = V_{GS}, I_D = 250\mu A$
Drain-Source Leakage Current	I_{DSS}			50	μA	$V_{DS} = 24V, V_{GS} = 0$
				6.0	mA	$V_{DS} = 24V, V_{GS} = 0,$ $T_j = 100^\circ C$
Gate-Source Leakage Current*	I_{GSS}			± 100	nA	$V_{GS} = \pm 20V$
Total Gate Charge*	Q_G		9.5	14	nC	$V_{GS} = 4.5V, I_D = 7.0A$ $V_{DS} = 16V$
Pre-Vth Gate-Source Charge	Q_{GS1}		2.3			
Post-Vth Gate-Source Charge	Q_{GS2}		1.0			
Gate to Drain Charge	Q_{GD}		2.4			
Switch Chg($Q_{GS2} + Q_{GD}$)	Q_{SW}		3.4	5.2		
Output Charge*	Q_{OSS}		12	16.8		
Gate Resistance	R_G		2.0		Ω	
Turn-on Delay Time	$t_{d(on)}$		6.3		ns	$V_{DD} = 16V, I_D = 7.0A$ $V_{GS} = 5V, R_G = 2\Omega$ Resistive Load
Rise Time	t_r		1.2			
Turn-off Delay Time	$t_{d(off)}$		11			
Fall Time	t_f		2.2			

Schottky Diode & Body Diode Ratings and Characteristics

Parameter		Min	Typ	Max	Units	Conditions
Diode Forward Voltage	V_{SD}			0.54	V	$T_j = 25^\circ C, I_s = 3.0A, V_{GS} = 0V^{\textcircled{2}}$
				0.43		$T_j = 125^\circ C, I_s = 3.0A, V_{GS} = 0V^{\textcircled{2}}$
Reverse Recovery Time	trr		36		ns	$T_j = 25^\circ C, I_s = 7.0A, V_{DS} = 16V$
Reverse Recovery Charge	Qrr		41		nC	di/dt = 100A/ μs
Forward Turn-On Time	t_{on}	Intrinsic turn-on time is negligible (turn-on is dominated by $L_s + L_D$)				

- Notes:**
- ① Repetitive rating; pulse width limited by max. junction temperature.
 - ② Pulse width $\leq 400 \mu s$; duty cycle $\leq 2\%$.
 - ③ When mounted on 1 inch square copper board
 - ④ 50% Duty Cycle, Rectangular
 - ⑤ Typical values of $R_{DS(on)}$ measured at $V_{GS} = 4.5V$, Q_G , Q_{SW} and Q_{OSS} measured at $V_{GS} = 5.0V, I_D = 7.0A$.
 - * Device are 100% tested to these parameters.

Power MOSFET Selection for DC/DC Converters

Control FET

Special attention has been given to the power losses in the switching elements of the circuit - Q1 and Q2. Power losses in the high side switch Q1, also called the Control FET, are impacted by the $R_{ds(on)}$ of the MOSFET, but these conduction losses are only about one half of the total losses.

Power losses in the control switch Q1 are given by;

$$P_{loss} = P_{conduction} + P_{switching} + P_{drive} + P_{output}$$

This can be expanded and approximated by;

$$P_{loss} = (I_{rms}^2 \times R_{ds(on)}) + \left(I \times \frac{Q_{gd}}{i_g} \times V_{in} \times f \right) + \left(I \times \frac{Q_{gs2}}{i_g} \times V_{in} \times f \right) + (Q_g \times V_g \times f) + \left(\frac{Q_{oss}}{2} \times V_{in} \times f \right)$$

This simplified loss equation includes the terms Q_{gs2} and Q_{oss} which are new to Power MOSFET data sheets. Q_{gs2} is a sub element of traditional gate-source charge that is included in all MOSFET data sheets. The importance of splitting this gate-source charge into two sub elements, Q_{gs1} and Q_{gs2} , can be seen from Fig 1.

Q_{gs2} indicates the charge that must be supplied by the gate driver between the time that the threshold voltage has been reached (t1) and the time the drain current rises to I_{dmax} (t2) at which time the drain voltage begins to change. Minimizing Q_{gs2} is a critical factor in reducing switching losses in Q1.

Q_{oss} is the charge that must be supplied to the output capacitance of the MOSFET during every switching cycle. Figure 2 shows how Q_{oss} is formed by the parallel combination of the voltage dependant (non-linear) capacitance's C_{ds} and C_{dg} when multiplied by the power supply input buss voltage.

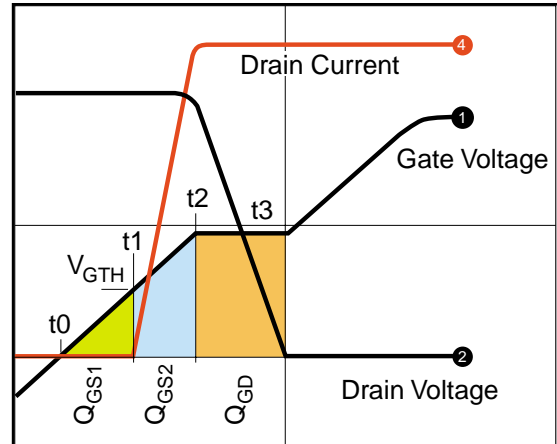

Figure 1: Typical MOSFET switching waveform

Synchronous FET

The power loss equation for Q2 is approximated by;

$$P_{loss} = P_{conduction} + P_{drive} + P_{output}^* \\ P_{loss} = (I_{rms}^2 \times R_{ds(on)}) + (Q_g \times V_g \times f) + \left(\frac{Q_{oss}}{2} \times V_{in} \times f \right) + (Q_{rr} \times V_{in} \times f)$$

*dissipated primarily in Q1.

IRF7807VD2

International
IR Rectifier

For the synchronous MOSFET Q2, $R_{ds(on)}$ is an important characteristic; however, once again the importance of gate charge must not be overlooked since it impacts three critical areas. Under light load the MOSFET must still be turned on and off by the control IC so the gate drive losses become much more significant. Secondly, the output charge Q_{oss} and reverse recovery charge Q_{rr} both generate losses that are transferred to Q1 and increase the dissipation in that device. Thirdly, gate charge will impact the MOSFETs' susceptibility to Cdv/dt turn on.

The drain of Q2 is connected to the switching node of the converter and therefore sees transitions between ground and V_{in} . As Q1 turns on and off there is a rate of change of drain voltage dV/dt which is capacitively coupled to the gate of Q2 and can induce a voltage spike on the gate that is sufficient to turn

the MOSFET on, resulting in shoot-through current. The ratio of Q_{gd}/Q_{gs1} must be minimized to reduce the potential for Cdv/dt turn on.

Spice model for IRF7807V can be downloaded in machine readable format at www.irf.com.

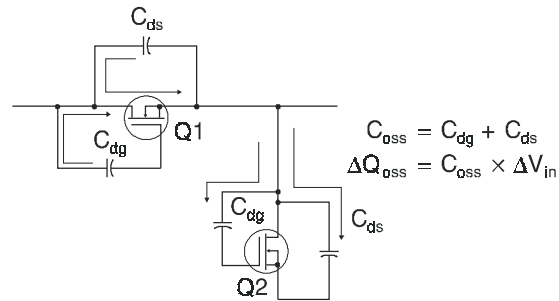

Figure 2: Q_{oss} Characteristic

Typical Mobile PC Application

The performance of these new devices has been tested in circuit and correlates well with performance predictions generated by the system models. An advantage of this new technology platform is that the MOSFETs it produces are suitable for both control FET and synchronous FET applications. This has been demonstrated with the 3.3V and 5V converters. (Fig 3 and Fig 4). In these applications the same MOSFET IRF7807V was used for both the control FET (Q1) and the synchronous FET (Q2). This provides a highly effective cost/performance solution.

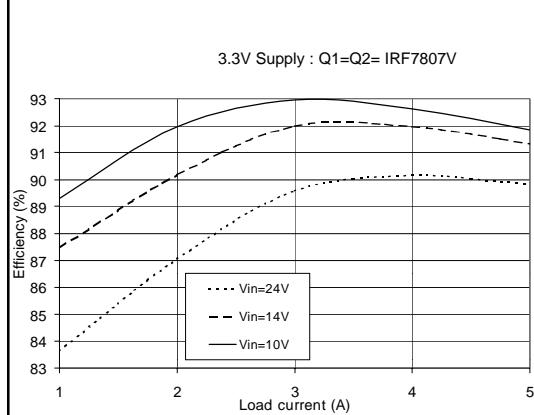

Figure 3

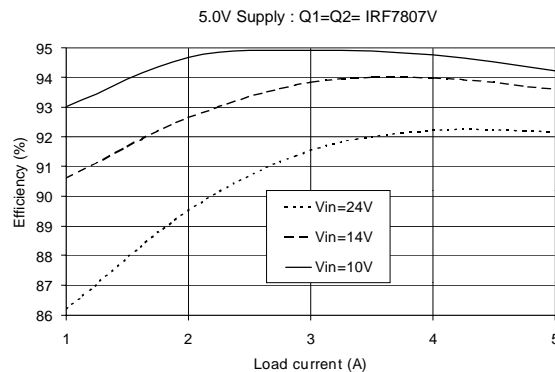

Figure 4

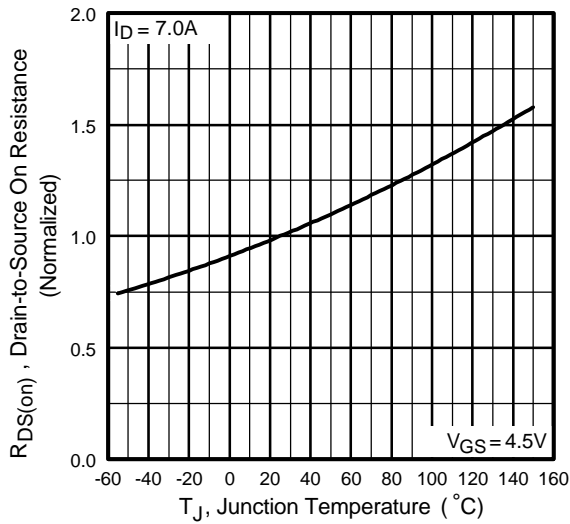

Fig 5. Normalized On-Resistance Vs. Temperature

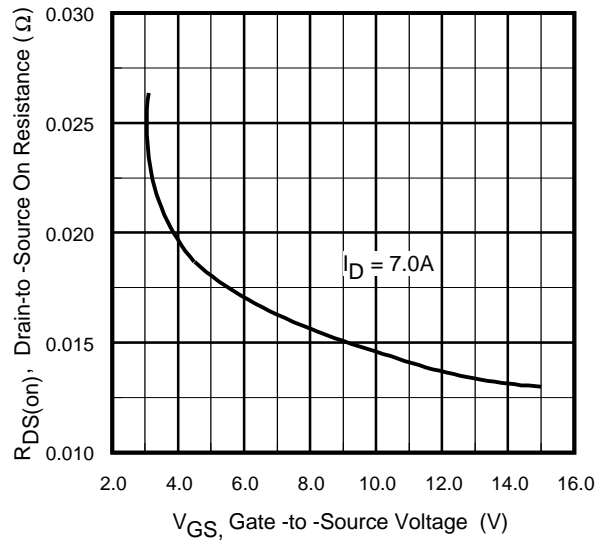

Fig 7. On-Resistance Vs. Gate Voltage

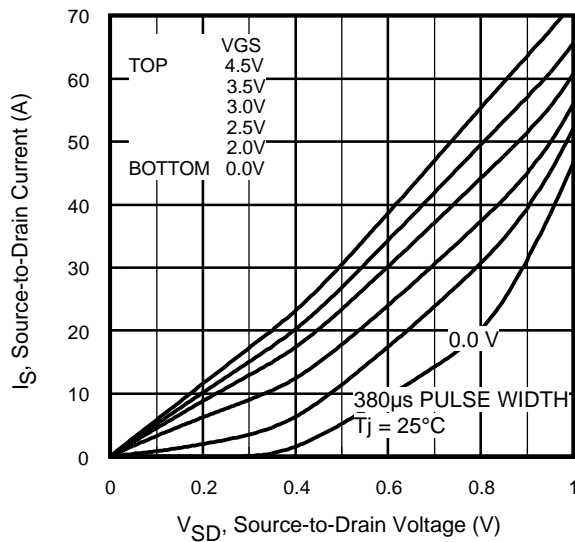

Fig 7. Typical Reverse Output Characteristics

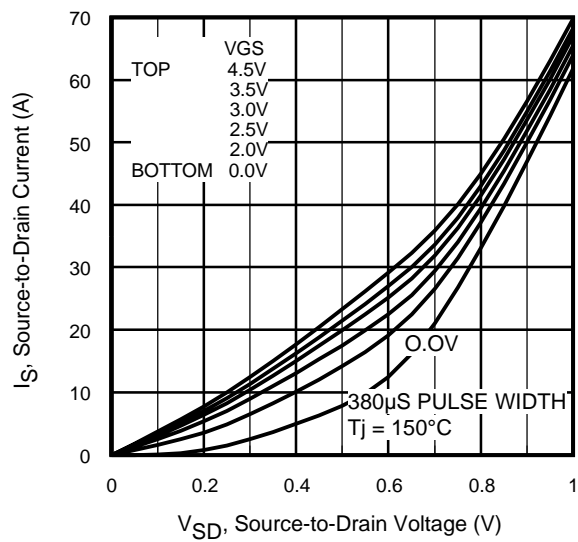

Fig 8. Typical Reverse Output Characteristics

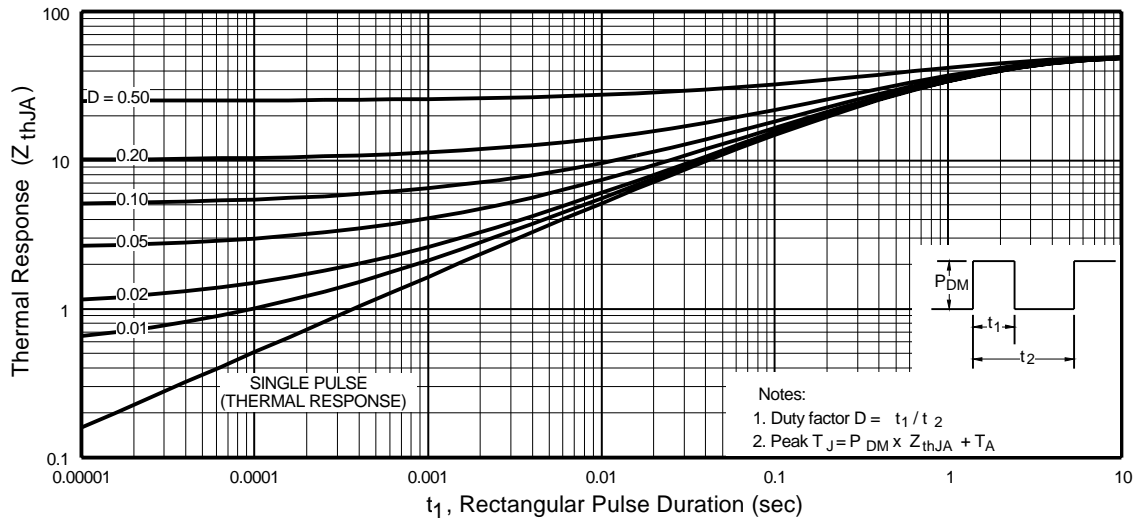

Figure 9. Maximum Effective Transient Thermal Impedance, Junction-to-Ambient

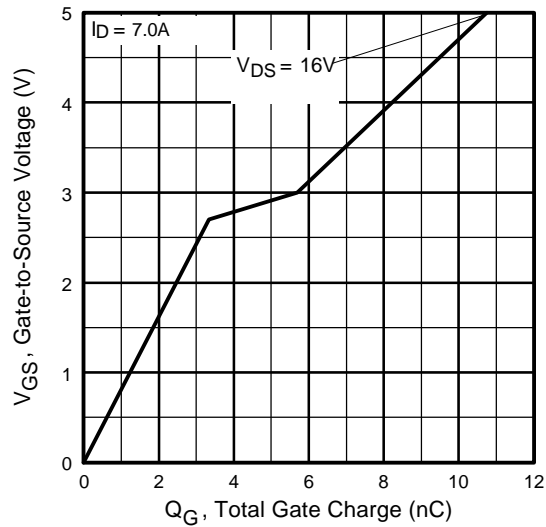

Fig 10. Typical Gate Charge Vs. Gate-to-Source Voltage

MOSFET , Body Diode & Schottky Diode Characteristics

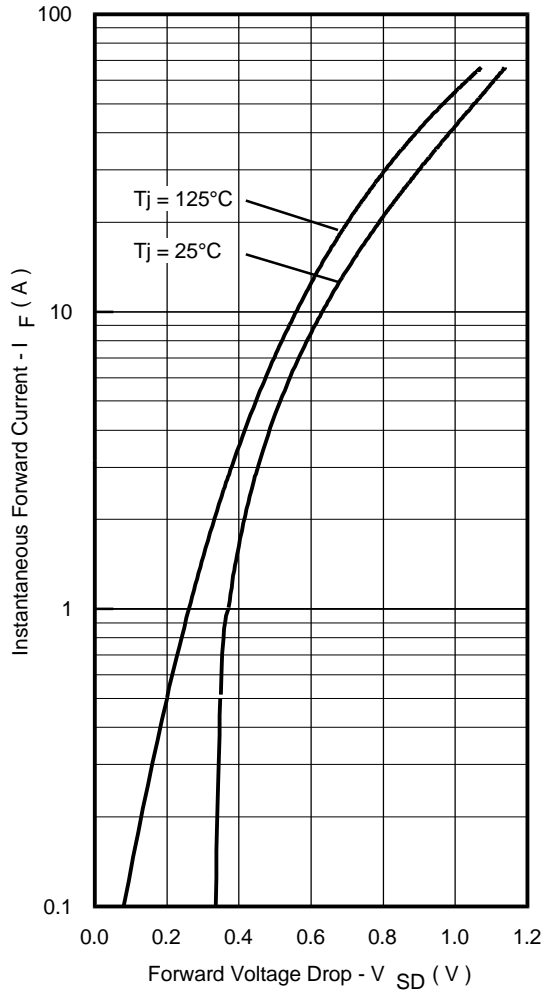

Fig. 11 - Typical Forward Voltage Drop Characteristics

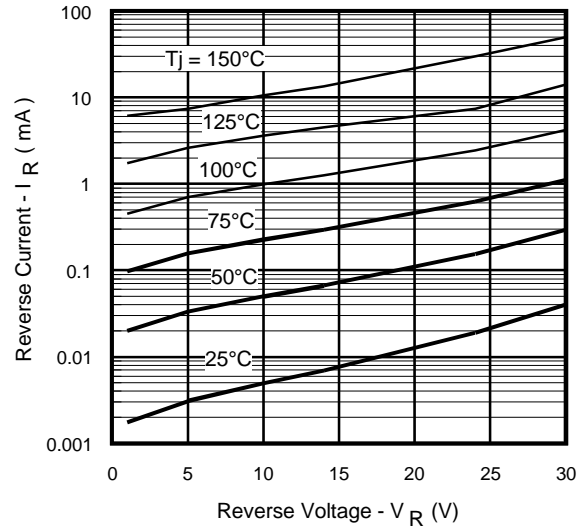
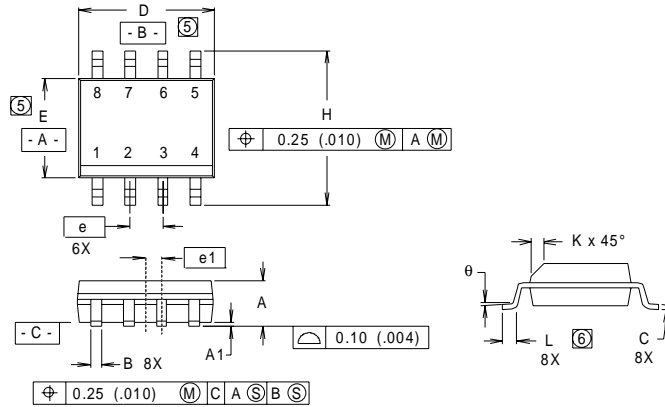

Fig. 12 - Typical Values of Reverse Current Vs. Reverse Voltage

IRF7807VD2

International
IR Rectifier

SO-8 Package Details



DIM	INCHES		MILLIMETERS	
	MIN	MAX	MIN	MAX
A	.0532	.0688	1.35	1.75
A1	.0040	.0098	0.10	0.25
B	.014	.018	0.36	0.46
C	.0075	.0098	0.19	0.25
D	.189	.196	4.80	4.98
E	.150	.157	3.81	3.99
e	.050 BASIC		1.27 BASIC	
e1	.025 BASIC		0.635 BASIC	
H	.2284	.2440	5.80	6.20
K	.011	.019	0.28	0.48
L	0.16	.050	0.41	1.27
θ	0°	8°	0°	8°

RECOMMENDED FOOTPRINT

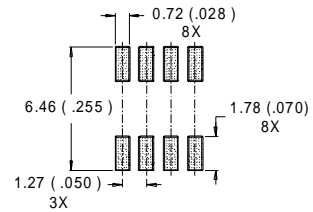

NOTES:

1. DIMENSIONING AND TOLERANCING PER ANS Y14.5M-1982.
2. CONTROLLING DIMENSION : INCH.
3. DIMENSIONS ARE SHOWN IN MILLIMETERS (INCHES).
4. OUTLINE CONFORMS TO JEDEC OUTLINE MS-012AA.
- ⑤ DIMENSION DOES NOT INCLUDE MOLD PROTRUSIONS
MOLD PROTRUSIONS NOT TO EXCEED 0.25 (.006).
- ⑥ DIMENSIONS IS THE LENGTH OF LEAD FOR SOLDERING TO A SUBSTRATE..

SO-8 Part Marking

SO-8 (MS-012AA)

EXAMPLE: THIS IS AN IRF7807D1 (FETKY)

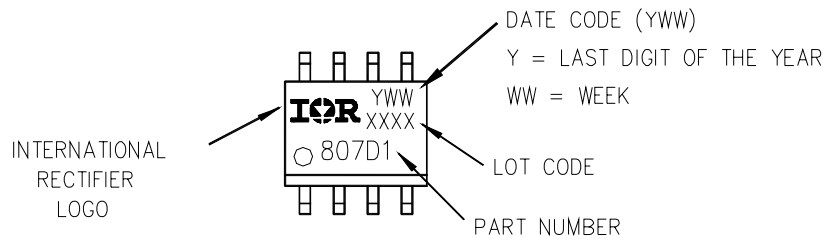

SO-8 Tape and Reel

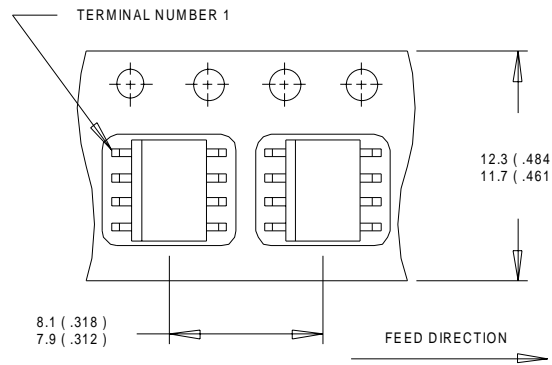

- NOTES:
1. CONTROLLING DIMENSION : MILLIMETER.
 2. ALL DIMENSIONS ARE SHOWN IN MILLIMETERS(INCHES).
 3. OUTLINE CONFORMS TO EIA-481 & EIA-541.

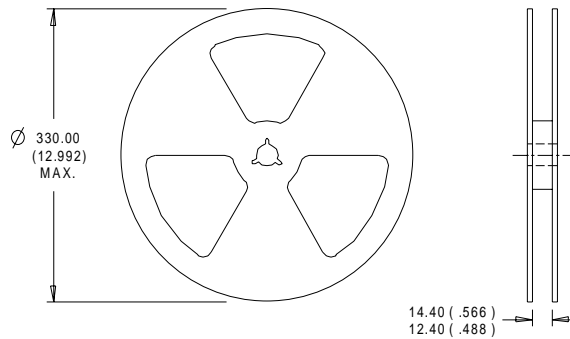

- NOTES :
1. CONTROLLING DIMENSION : MILLIMETER.
 2. OUTLINE CONFORMS TO EIA-481 & EIA-541.

This product has been designed and qualified for the commercial market.
 Qualification Standards can be found on IR's Web site.

International
IR Rectifier

IR WORLD HEADQUARTERS: 233 Kansas St., El Segundo, California 90245, USA Tel: (310) 252-7105
 TAC Fax: (310) 252-7903

Visit us at www.irf.com for sales contact information.
 Data and specifications subject to change without notice. 03/01



LittleDiode supplies new, hard to find or obsolete electronic components and semiconductors all over the world.

With over two million different components listed you are sure to find the part you need.

Feel free to visit us today at our online store:

LittleDiode.com

Looking forward to providing you with the best possible service.