

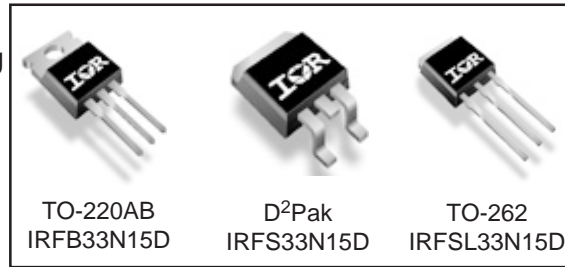
**Applications**

- High frequency DC-DC converters

$V_{DSS}$	$R_{DS(on) \max}$	$I_D$
150V	0.056Ω	33A

**Benefits**

- Low Gate-to-Drain Charge to Reduce Switching Losses
- Fully Characterized Capacitance Including Effective  $C_{OSS}$  to Simplify Design, (See App. Note AN1001)
- Fully Characterized Avalanche Voltage and Current



**Absolute Maximum Ratings**

	Parameter	Max.	Units
$I_D @ T_C = 25^\circ\text{C}$	Continuous Drain Current, $V_{GS} @ 10\text{V}$	33	A
$I_D @ T_C = 100^\circ\text{C}$	Continuous Drain Current, $V_{GS} @ 10\text{V}$	24	
$I_{DM}$	Pulsed Drain Current ①	130	
$P_D @ T_A = 25^\circ\text{C}$	Power Dissipation ⑦	3.8	W
$P_D @ T_C = 25^\circ\text{C}$	Power Dissipation	170	
	Linear Derating Factor	1.1	W/°C
$V_{GS}$	Gate-to-Source Voltage	± 30	V
dv/dt	Peak Diode Recovery dv/dt ③	4.4	V/ns
$T_J$	Operating Junction and	-55 to + 175	°C
$T_{STG}$	Storage Temperature Range		
	Soldering Temperature, for 10 seconds		
	Mounting torque, 6-32 or M3 screw ⑥	10 lbf•in (1.1N•m)	

**Typical SMPS Topologies**

- Telecom 48V input Active Clamp Forward Converter

Notes ① through ⑦ are on page 11

www.irf.com

# IRFB/IRFS/IRFSL33N15D

Static @  $T_J = 25^\circ\text{C}$  (unless otherwise specified)

International  
IR Rectifier

	Parameter	Min.	Typ.	Max.	Units	Conditions
$V_{(BR)DSS}$	Drain-to-Source Breakdown Voltage	150	—	—	V	$V_{GS} = 0V, I_D = 250\mu A$
$\Delta V_{(BR)DSS}/\Delta T_J$	Breakdown Voltage Temp. Coefficient	—	0.18	—	$V/^\circ\text{C}$	Reference to $25^\circ\text{C}, I_D = 1\text{mA}$ ⑥
$R_{DS(on)}$	Static Drain-to-Source On-Resistance	—	—	0.056	$\Omega$	$V_{GS} = 10V, I_D = 20A$ ④
$V_{GS(th)}$	Gate Threshold Voltage	3.0	—	5.5	V	$V_{DS} = V_{GS}, I_D = 250\mu A$
$I_{DSS}$	Drain-to-Source Leakage Current	—	—	25	$\mu A$	$V_{DS} = 150V, V_{GS} = 0V$
		—	—	250		$V_{DS} = 120V, V_{GS} = 0V, T_J = 150^\circ\text{C}$
$I_{GSS}$	Gate-to-Source Forward Leakage	—	—	100	nA	$V_{GS} = 30V$
	Gate-to-Source Reverse Leakage	—	—	-100		$V_{GS} = -30V$

Dynamic @  $T_J = 25^\circ\text{C}$  (unless otherwise specified)

	Parameter	Min.	Typ.	Max.	Units	Conditions
$g_{fs}$	Forward Transconductance	14	—	—	S	$V_{DS} = 50V, I_D = 20A$
$Q_g$	Total Gate Charge	—	60	90	nC	$I_D = 20A$ $V_{DS} = 120V$ $V_{GS} = 10V, ④⑥$
$Q_{gs}$	Gate-to-Source Charge	—	17	26		
$Q_{gd}$	Gate-to-Drain ("Miller") Charge	—	27	41		
$t_{d(on)}$	Turn-On Delay Time	—	13	—	ns	$V_{DD} = 75V$ $I_D = 20A$ $R_G = 3.6\Omega$ $V_{GS} = 10V\Omega$ ④
$t_r$	Rise Time	—	38	—		
$t_{d(off)}$	Turn-Off Delay Time	—	23	—		
$t_f$	Fall Time	—	21	—		
$C_{iss}$	Input Capacitance	—	2020	—	pF	$V_{GS} = 0V$ $V_{DS} = 25V$ $f = 1.0\text{MHz}$ ⑥ $V_{GS} = 0V, V_{DS} = 1.0V, f = 1.0\text{MHz}$ $V_{GS} = 0V, V_{DS} = 120V, f = 1.0\text{MHz}$ $V_{GS} = 0V, V_{DS} = 0V \text{ to } 120V$ ⑤
$C_{oss}$	Output Capacitance	—	400	—		
$C_{rss}$	Reverse Transfer Capacitance	—	91	—		
$C_{oss}$	Output Capacitance	—	2440	—		
$C_{oss}$	Output Capacitance	—	180	—		
$C_{oss \text{ eff.}}$	Effective Output Capacitance	—	320	—		

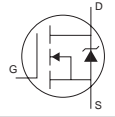
## Avalanche Characteristics

	Parameter	Typ.	Max.	Units
$E_{AS}$	Single Pulse Avalanche Energy②⑥	—	330	mJ
$I_{AR}$	Avalanche Current①	—	20	A
$E_{AR}$	Repetitive Avalanche Energy①	—	17	mJ

## Thermal Resistance

	Parameter	Typ.	Max.	Units
$R_{\theta JC}$	Junction-to-Case	—	0.90	$^\circ\text{C/W}$
$R_{\theta CS}$	Case-to-Sink, Flat, Greased Surface ⑥	0.50	—	
$R_{\theta JA}$	Junction-to-Ambient⑥	—	62	
$R_{\theta JA}$	Junction-to-Ambient⑦	—	40	

## Diode Characteristics

	Parameter	Min.	Typ.	Max.	Units	Conditions
$I_S$	Continuous Source Current (Body Diode)	—	—	33	A	MOSFET symbol showing the integral reverse p-n junction diode. 
$I_{SM}$	Pulsed Source Current (Body Diode) ①⑥	—	—	130		
$V_{SD}$	Diode Forward Voltage	—	—	1.3	V	$T_J = 25^\circ\text{C}, I_S = 20A, V_{GS} = 0V$ ④
$t_{rr}$	Reverse Recovery Time	—	150	—	ns	$T_J = 25^\circ\text{C}, I_F = 20A$
$Q_{rr}$	Reverse Recovery Charge	—	920	—	nC	$di/dt = 100A/\mu s$ ④
$t_{on}$	Forward Turn-On Time	Intrinsic turn-on time is negligible (turn-on is dominated by $L_S+L_D$ )				

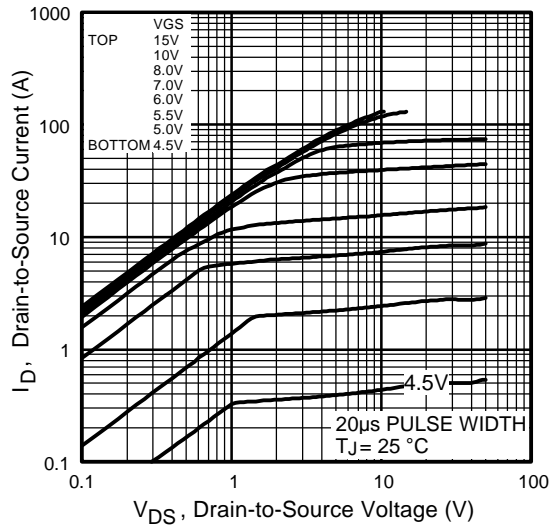


Fig 1. Typical Output Characteristics

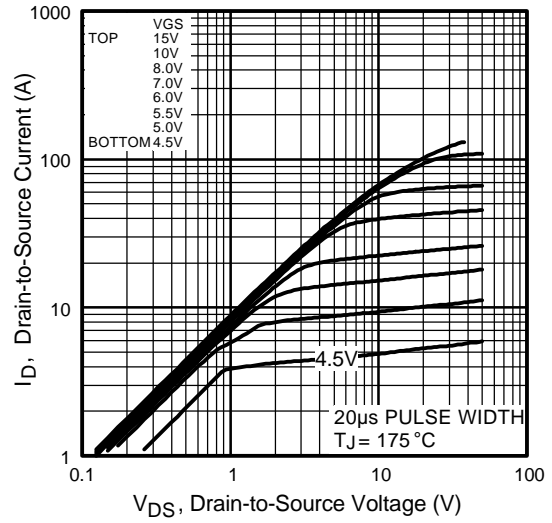


Fig 2. Typical Output Characteristics

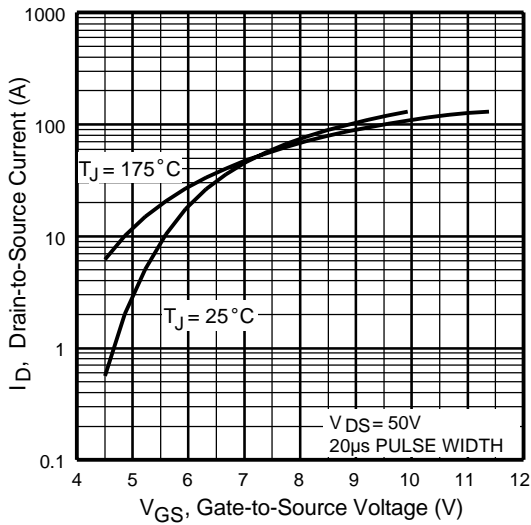


Fig 3. Typical Transfer Characteristics

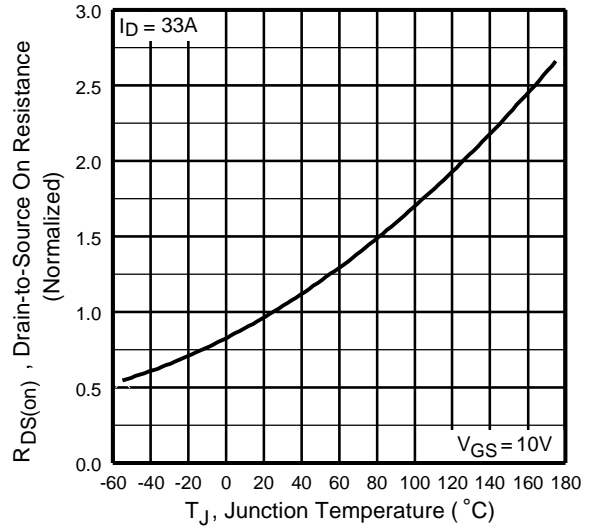
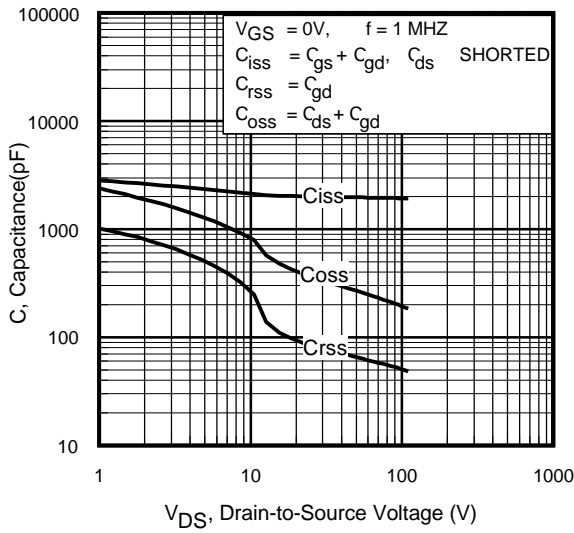
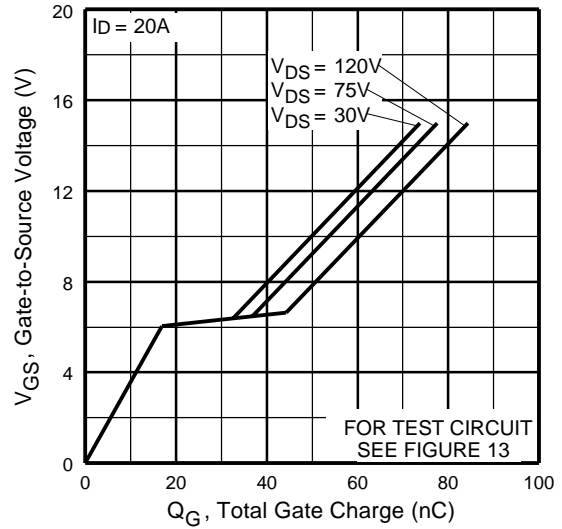


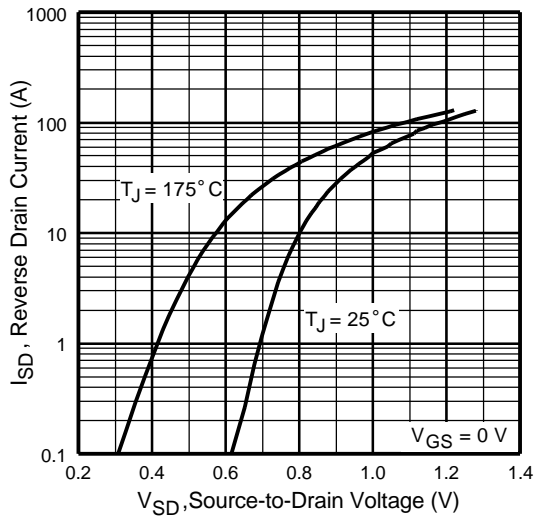
Fig 4. Normalized On-Resistance Vs. Temperature



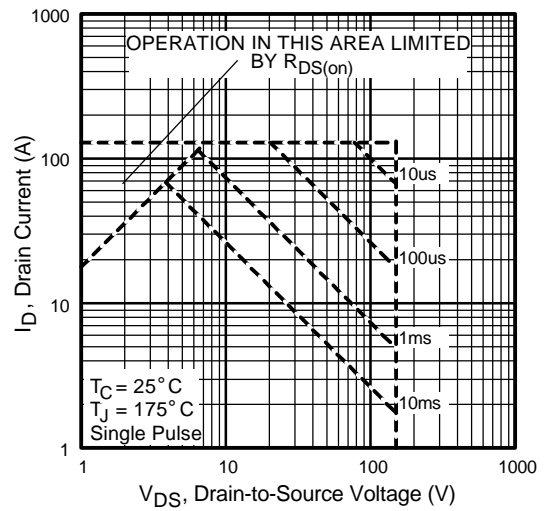
**Fig 5.** Typical Capacitance Vs. Drain-to-Source Voltage



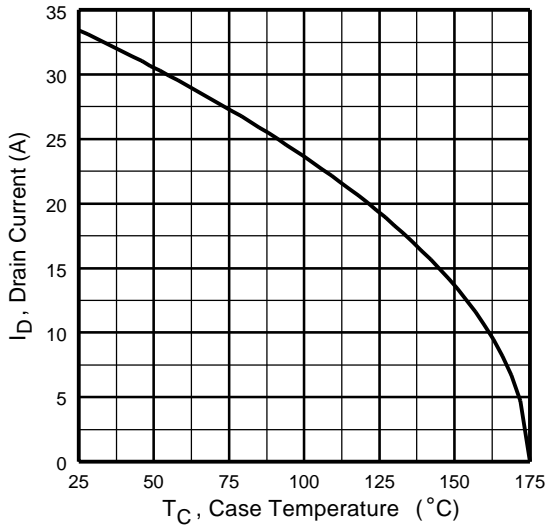
**Fig 6.** Typical Gate Charge Vs. Gate-to-Source Voltage



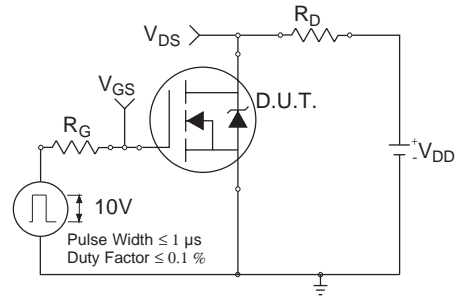
**Fig 7.** Typical Source-Drain Diode Forward Voltage



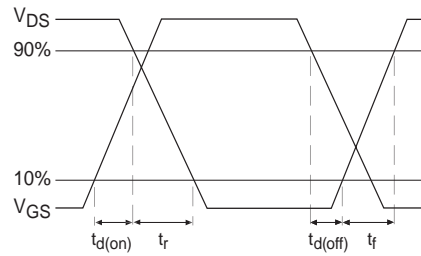
**Fig 8.** Maximum Safe Operating Area



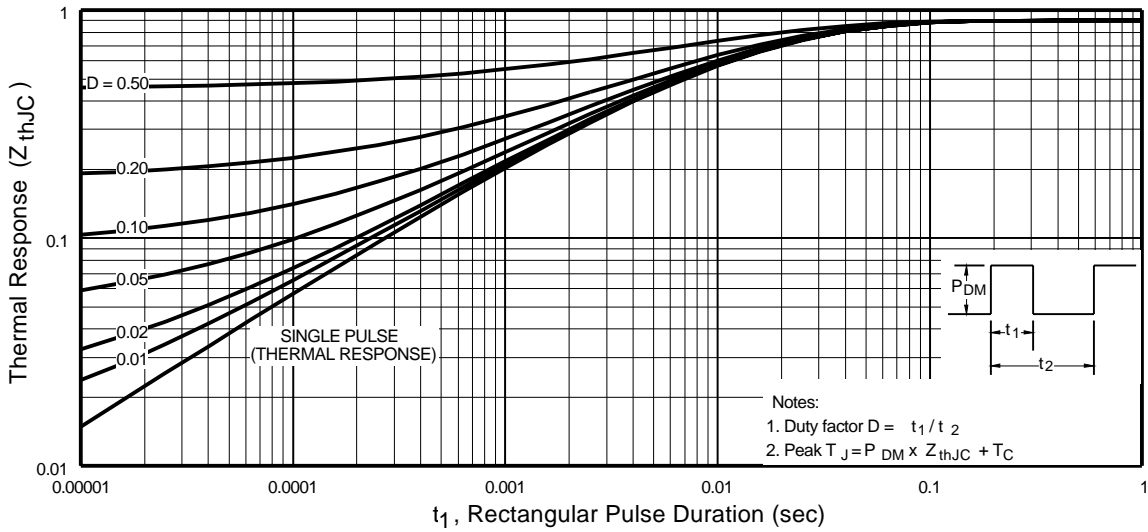
**Fig 9.** Maximum Drain Current Vs. Case Temperature



**Fig 10a.** Switching Time Test Circuit



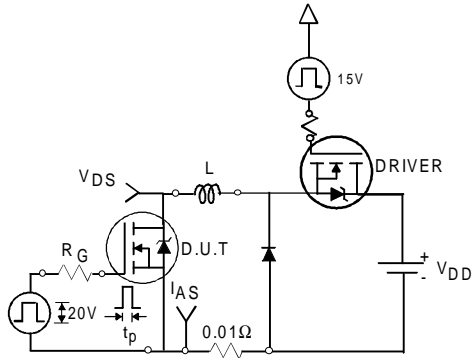
**Fig 10b.** Switching Time Waveforms



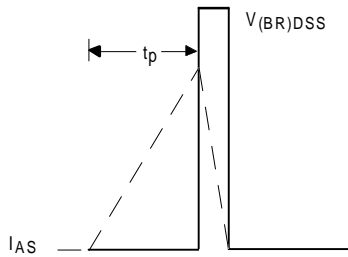
**Fig 11.** Maximum Effective Transient Thermal Impedance, Junction-to-Case

# IRFB/IRFS/IRFSL33N15D

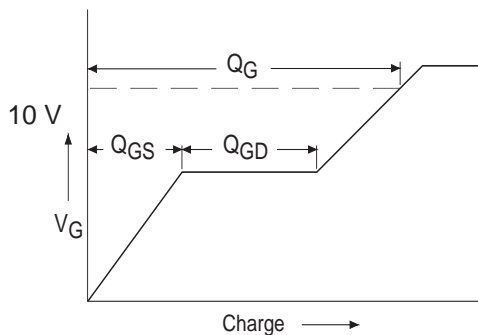
International  
**IR** Rectifier



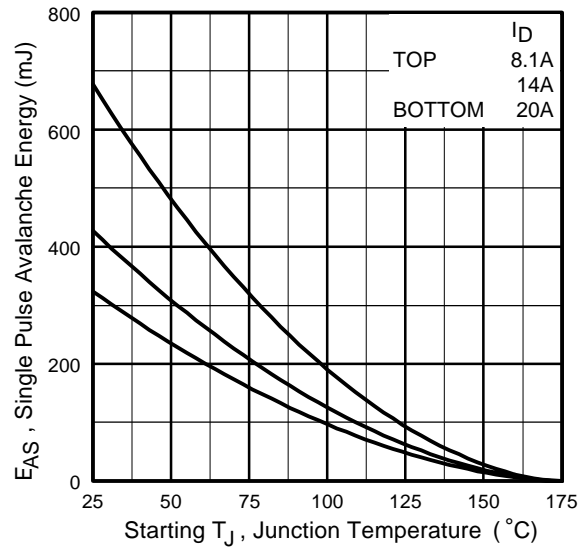
**Fig 12a.** Unclamped Inductive Test Circuit



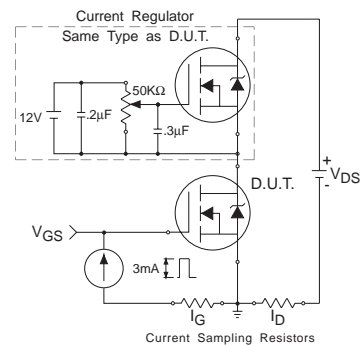
**Fig 12b.** Unclamped Inductive Waveforms



**Fig 13a.** Basic Gate Charge Waveform

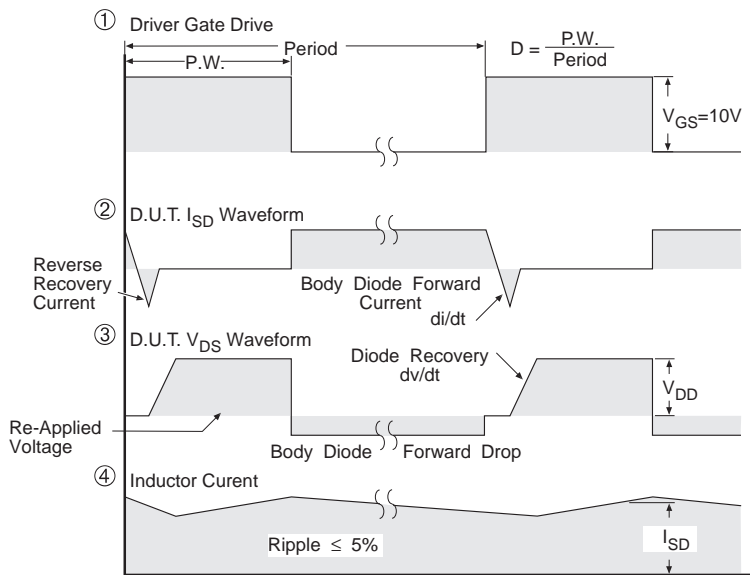
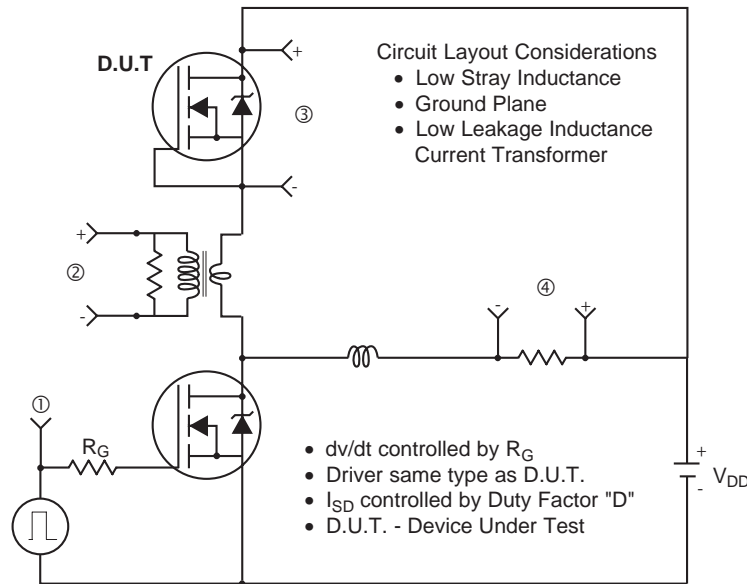


**Fig 12c.** Maximum Avalanche Energy Vs. Drain Current



**Fig 13b.** Gate Charge Test Circuit

**Peak Diode Recovery dv/dt Test Circuit**



\*  $V_{GS} = 5V$  for Logic Level Devices

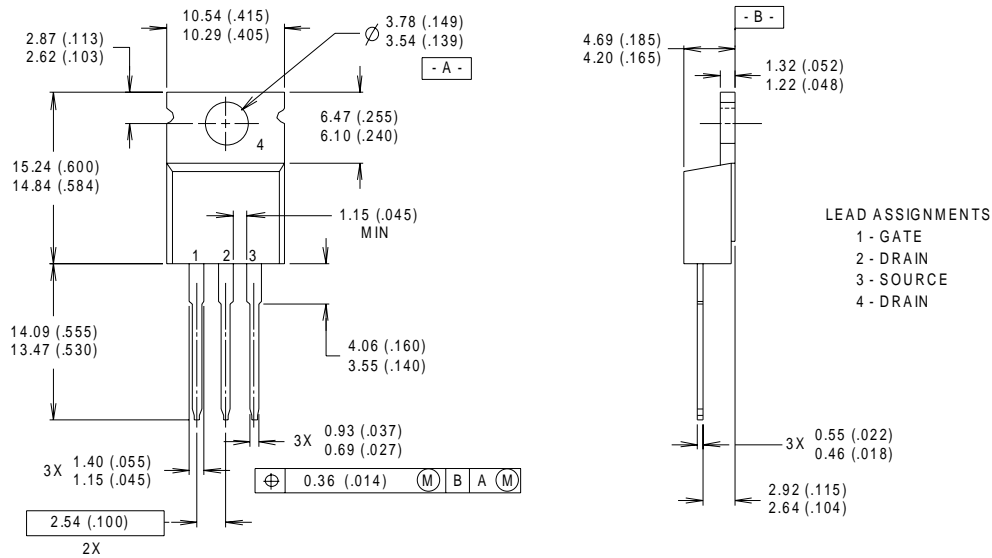
**Fig 14.** For N-Channel HEXFET® Power MOSFETs

# IRFB/IRFS/IRFSL33N15D



## TO-220AB Package Outline

Dimensions are shown in millimeters (inches)



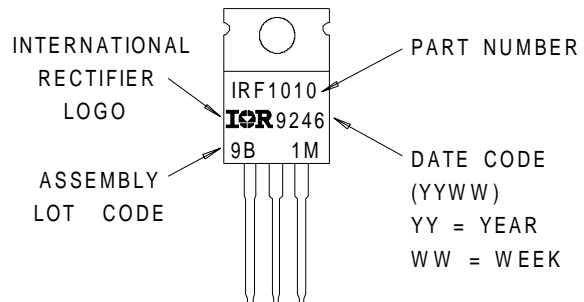
### NOTES:

- 1 DIMENSIONING & TOLERANCING PER ANSI Y14.5M, 1982.
- 2 CONTROLLING DIMENSION : INCH

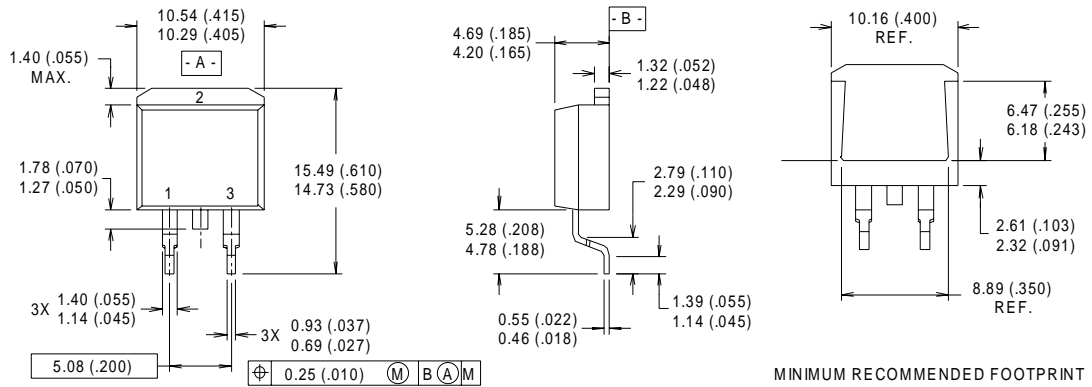
- 3 OUTLINE CONFORMS TO JEDEC OUTLINE TO-220AB.
- 4 HEATSINK & LEAD MEASUREMENTS DO NOT INCLUDE BURRS.

## TO-220AB Part Marking Information

EXAMPLE : THIS IS AN IRF1010  
WITH ASSEMBLY  
LOT CODE 9B1M



## D<sup>2</sup>Pak Package Outline



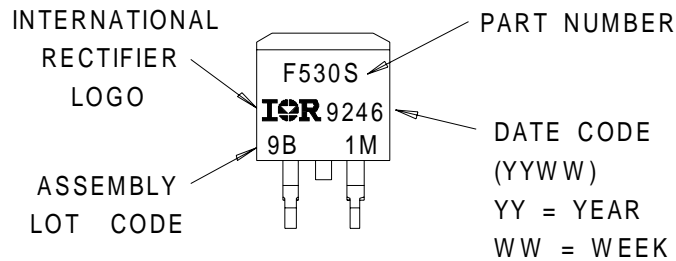
**NOTES:**

- 1 DIMENSIONS AFTER SOLDER DIP.
- 2 DIMENSIONING & TOLERANCING PER ANSI Y14.5M, 1982.
- 3 CONTROLLING DIMENSION : INCH.
- 4 HEATSINK & LEAD DIMENSIONS DO NOT INCLUDE BURRS.

**LEAD ASSIGNMENTS**

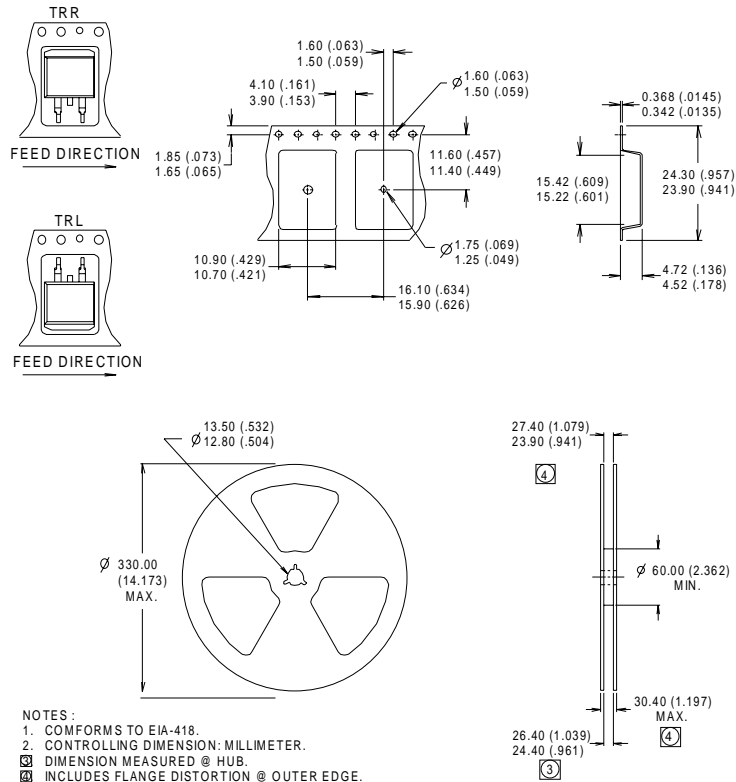
- 1 - GATE
- 2 - DRAIN
- 3 - SOURCE

## D<sup>2</sup>Pak Part Marking Information





## D<sup>2</sup>Pak Tape & Reel Information



**Notes:**

- ① Repetitive rating; pulse width limited by max. junction temperature.
- ② Starting  $T_J = 25^\circ\text{C}$ ,  $L = 1.7\text{mH}$   
 $R_G = 25\Omega$ ,  $I_{AS} = 20\text{A}$ .
- ③  $I_{SD} \leq 20\text{A}$ ,  $di/dt \leq 280\text{A}/\mu\text{s}$ ,  $V_{DD} \leq V_{(BR)DSS}$ ,  
 $T_J \leq 175^\circ\text{C}$
- ④ Pulse width  $\leq 300\mu\text{s}$ ; duty cycle  $\leq 2\%$ .
- ⑤  $C_{OSS}$  eff. is a fixed capacitance that gives the same charging time as  $C_{OSS}$  while  $V_{DS}$  is rising from 0 to 80%  $V_{DSS}$
- ⑥ This is only applied to TO-220AB package
- ⑦ This is applied to D<sup>2</sup>Pak, when mounted on 1" square PCB ( FR-4 or G-10 Material ).  
 For recommended footprint and soldering techniques refer to application note #AN-994.



LittleDiode supplies new, hard to find or obsolete electronic components and semiconductors all over the world.

With over two million different components listed you are sure to find the part you need.

Feel free to visit us today at our online store:

[LittleDiode.com](http://LittleDiode.com)

Looking forward to providing you with the best possible service.