

# HiPerFET™

## Power MOSFETs ISOPLUS247™, Q-Class

IXFR 44N50Q

IXFR 48N50Q

$V_{DSS}$	$I_{D25}$	$R_{DS(on)}$
500 V	34 A	120 mΩ
500 V	40 A	110 mΩ

(Electrically Isolated Backside)

N-Channel Enhancement Mode  
Avalanche Rated, Low  $Q_g$ , High  $dv/dt$

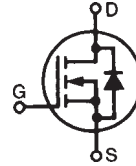

$t_{rr} \leq 250$  ns

Symbol	Test Conditions	Maximum Ratings	
$V_{DSS}$	$T_J = 25^\circ\text{C}$ to $150^\circ\text{C}$	500	V
$V_{DGR}$	$T_J = 25^\circ\text{C}$ to $150^\circ\text{C}$ ; $R_{GS} = 1$ MΩ	500	V
$V_{GS}$	Continuous	±20	V
$V_{GSM}$	Transient	±30	V
$I_{D25}$	$T_C = 25^\circ\text{C}$	44N50Q 34 48N50Q 40	A
$I_{DM}$	$T_C = 25^\circ\text{C}$ , Note 1	44N50Q 176 48N50Q 192	A
$I_{AR}$	$T_C = 25^\circ\text{C}$	44N50Q 44 48N50Q 48	A
$E_{AR}$	$T_C = 25^\circ\text{C}$	60	mJ
$E_{AS}$	$T_C = 25^\circ\text{C}$	2.5	J
$dv/dt$	$I_S \leq I_{DM}$ , $di/dt \leq 100$ A/μs, $V_{DD} \leq V_{DSS}$ $T_J \leq 150^\circ\text{C}$ , $R_G = 2$ Ω	15	V/ns
$P_D$	$T_C = 25^\circ\text{C}$	310	W
$T_J$		-55 ... +150	°C
$T_{JM}$		150	°C
$T_{stg}$		-55 ... +150	°C
$T_L$	1.6 mm (0.063 in.) from case for 10 s	300	°C
$V_{ISOL}$	50/60 Hz, RMS $t = 1$ min	2500	V~
Weight		5	g

ISOPLUS247™  
E153432

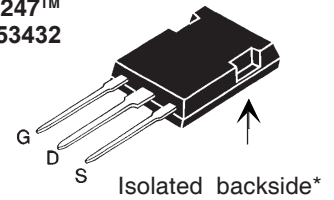

G = Gate      D = Drain  
S = Source

\* Patent pending

### Features

- Silicon chip on Direct-Copper-Bond substrate
  - High power dissipation
  - Isolated mounting surface
  - 2500V electrical isolation
- Low drain to tab capacitance (<30pF)
- IXYS advanced low  $Q_g$  process
- Rugged polysilicon gate cell structure
- Rated for Unclamped Inductive Load Switching (UIS)
- Fast intrinsic diode

### Applications

- DC-DC converters
- Battery chargers
- Switched-mode and resonant-mode power supplies
- DC choppers
- AC motor control

### Advantages

- Easy assembly
- Space savings
- High power density

Symbol	Test Conditions	Characteristic Values ( $T_J = 25^\circ\text{C}$ , unless otherwise specified)		
		min.	typ.	max.
$V_{DSS}$	$V_{GS} = 0$ V, $I_D = 250$ μA	500		V
$V_{GS(th)}$	$V_{DS} = V_{GS}$ , $I_D = 4$ mA	2.0		4.0 V
$I_{GSS}$	$V_{GS} = \pm 20$ V, $V_{DS} = 0$			±100 nA
$I_{DSS}$	$V_{DS} = V_{DSS}$ $V_{GS} = 0$ V			100 μA 2 mA
$R_{DS(on)}$	$V_{GS} = 10$ V, $I_D = I_T$ Notes 2, 3	44N50Q 48N50Q		120 mΩ 110 mΩ

Symbol	Test Conditions	Characteristic Values ( $T_J = 25^\circ\text{C}$ , unless otherwise specified)	Characteristic Values		
			min.	typ.	max.
$g_{fs}$	$V_{DS} = 10\text{ V}; I_D = I_T$	Notes 2, 3	30	42	S
$C_{iss}$	$V_{GS} = 0\text{ V}, V_{DS} = 25\text{ V}, f = 1\text{ MHz}$			7000	pF
$C_{oss}$				960	pF
$C_{rss}$				230	pF
$t_{d(on)}$	$V_{GS} = 10\text{ V}, V_{DS} = 0.5 \cdot V_{DSS}, I_D = I_T$ $R_G = 1\ \Omega$ (External), Notes 2, 3			33	ns
$t_r$				22	ns
$t_{d(off)}$				75	ns
$t_f$				10	ns
$Q_{g(on)}$	$V_{GS} = 10\text{ V}, V_{DS} = 0.5 \cdot V_{DSS}, I_D = I_T$ Notes 2, 3			190	nC
$Q_{gs}$				40	nC
$Q_{gd}$				86	nC
$R_{thJC}$				0.40	K/W
$R_{thCK}$				0.15	K/W

### Source-Drain Diode

Symbol	Test Conditions	Characteristic Values ( $T_J = 25^\circ\text{C}$ , unless otherwise specified)		
		min.	typ.	max.
$I_S$	$V_{GS} = 0\text{ V}$			48 A
$I_{SM}$	Repetitive; Note 1			192 A
$V_{SD}$	$I_F = I_T, V_{GS} = 0\text{ V}$ , Notes 2, 3			1.5 V
$t_{rr}$	$I_F = 25\text{ A}, -di/dt = 100\text{ A}/\mu\text{s}, V_R = 100\text{ V}$			250 ns
$Q_{RM}$				1.0 $\mu\text{C}$
$I_{RM}$				10 A

- Note: 1. Pulse width limited by  $T_{JM}$   
 2. Pulse test,  $t \leq 300\ \mu\text{s}$ , duty cycle  $d \leq 2\%$   
 3. IXFR44N50Q:  $I_T = 22\text{ A}$   
 IXFR48N50Q:  $I_T = 24\text{ A}$

### ISOPLUS 247 OUTLINE

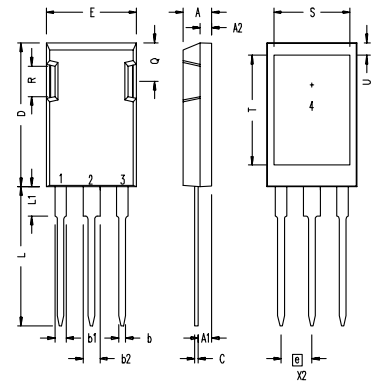

1 Gate, 2 Drain (Collector)  
 3 Source (Emitter)  
 4 no connection

Dim.	Millimeter		Inches	
	Min.	Max.	Min.	Max.
A	4.83	5.21	.190	.205
A <sub>1</sub>	2.29	2.54	.090	.100
A <sub>2</sub>	1.91	2.16	.075	.085
b	1.14	1.40	.045	.055
b <sub>1</sub>	1.91	2.13	.075	.084
b <sub>2</sub>	2.92	3.12	.115	.123
C	0.61	0.80	.024	.031
D	20.80	21.34	.819	.840
E	15.75	16.13	.620	.635
e	5.45 BSC		.215 BSC	
L	19.81	20.32	.780	.800
L1	3.81	4.32	.150	.170
Q	5.59	6.20	.220	.244
R	4.32	4.83	.170	.190

**Fig. 1. Output Characteristics  
@ 25 Deg. C**

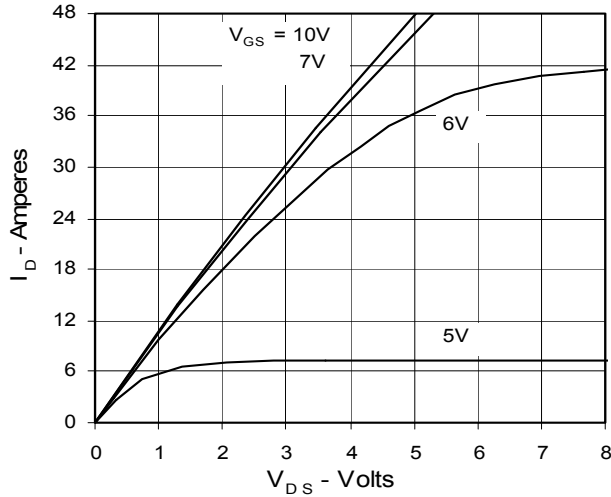

**Fig. 2. Extended Output Characteristics  
@ 25 deg. C**

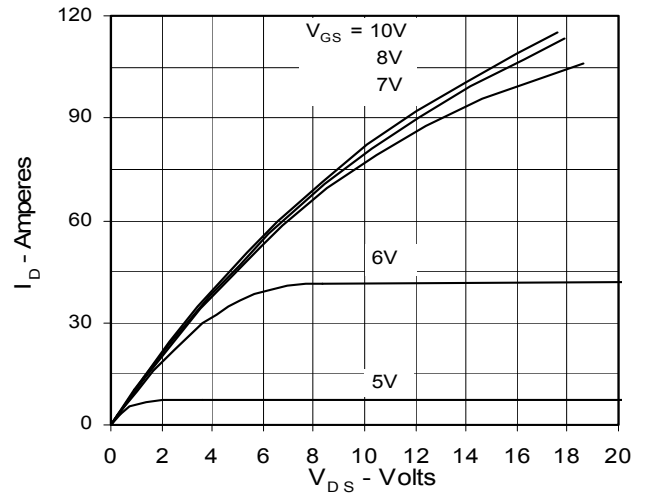

**Fig. 3. Output Characteristics  
@ 125 Deg. C**

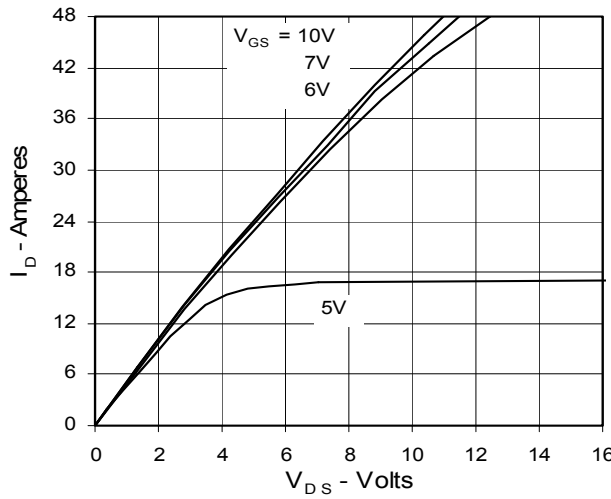

**Fig. 4.  $R_{DS(on)}$  Normalized to  $I_{D25}$  Value vs. Junction Temperature**

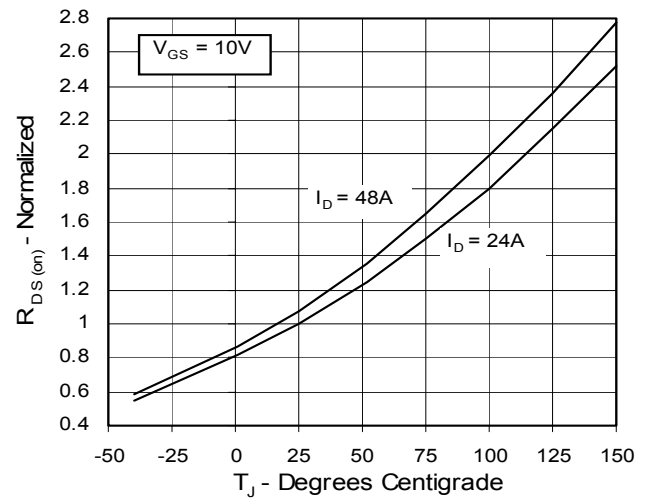

**Fig. 5.  $R_{DS(on)}$  Normalized to  $I_{D25}$  Value vs.  $I_D$**

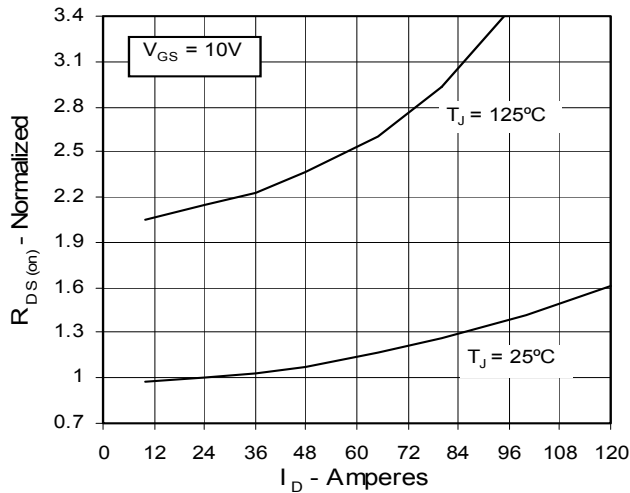

**Fig. 6. Drain Current vs. Case Temperature**

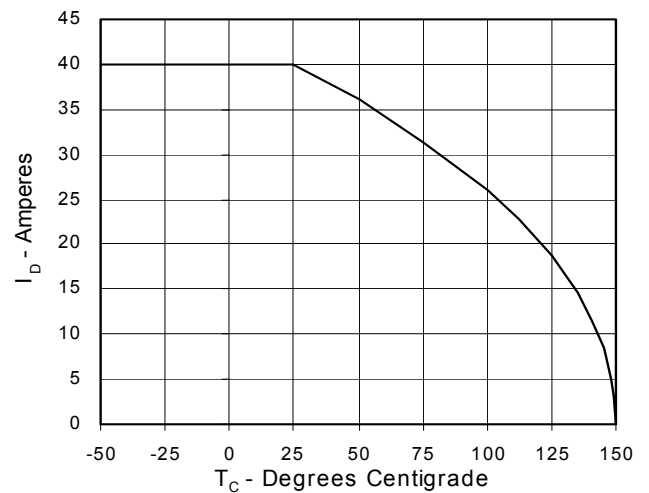

**Fig. 7. Input Admittance**

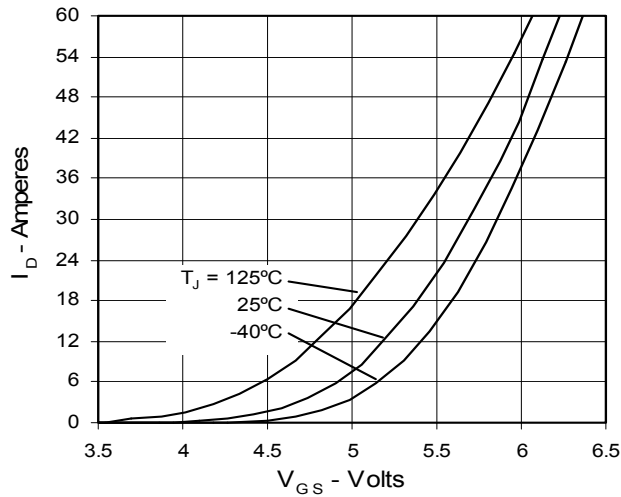

**Fig. 8. Transconductance**

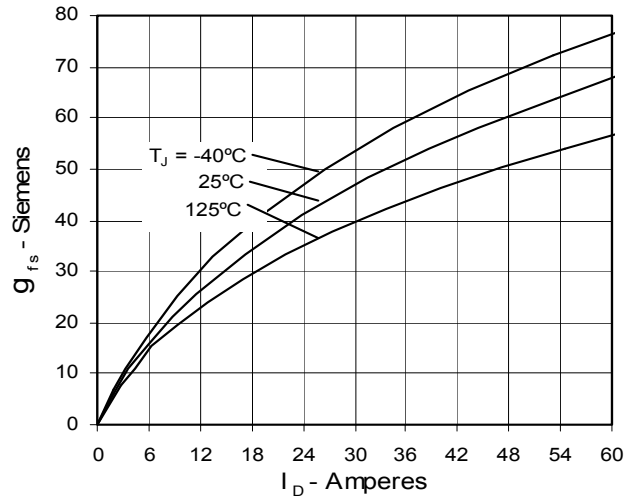

**Fig. 9. Source Current vs. Source-To-Drain Voltage**

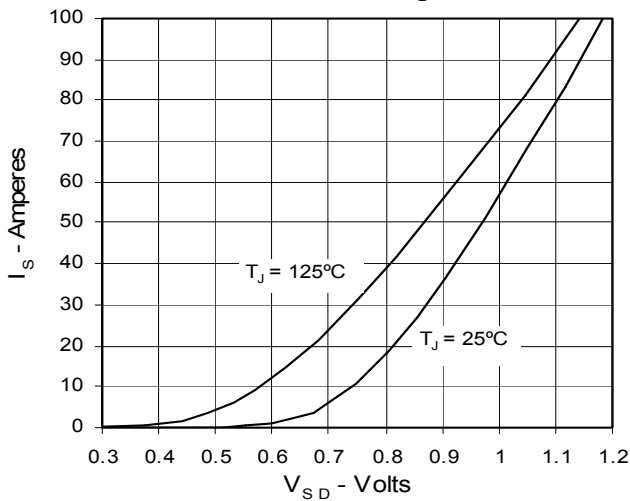

**Fig. 10. Gate Charge**

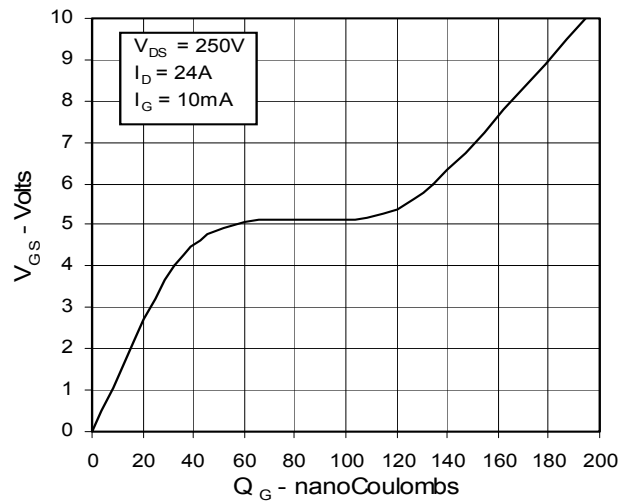

**Fig. 11. Capacitance**

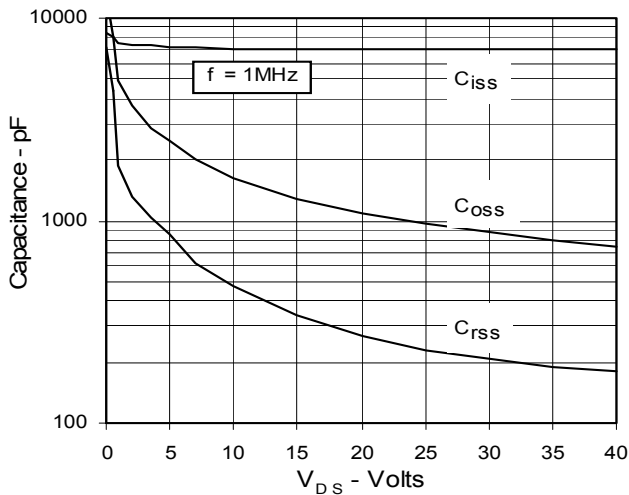

**Fig. 12. Maximum Transient Thermal Resistance**

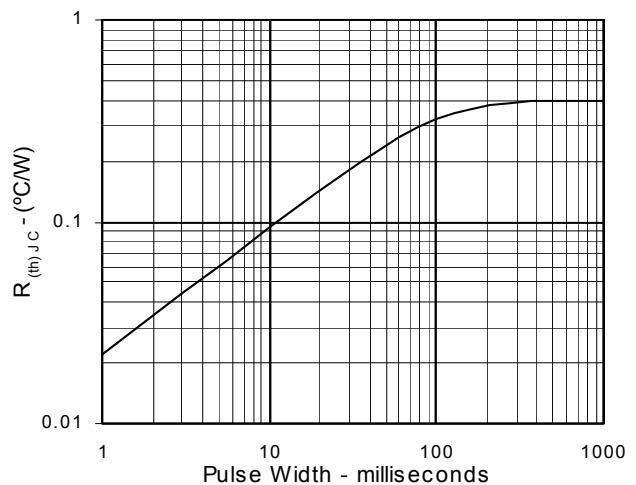

IXYS reserves the right to change limits, test conditions, and dimensions.

IXYS MOSFETs and IGBTs are covered by one or more of the following U.S. patents:

4,835,592	4,881,106	5,017,508	5,049,961	5,187,117	5,486,715	6,306,728B1	6,259,123B1	6,306,728B1
4,850,072	4,931,844	5,034,796	5,063,307	5,237,481	5,381,025	6,404,065B1	6,162,665	6,534,343



LittleDiode supplies new, hard to find or obsolete electronic components and semiconductors all over the world.

With over two million different components listed you are sure to find the part you need.

Feel free to visit us today at our online store:

[LittleDiode.com](http://LittleDiode.com)

Looking forward to providing you with the best possible service.