

High Speed IGBT

IXSH/IXST 30N60B
IXSH/IXST 30N60C

Short Circuit SOA Capability

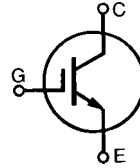

V_{CES}	I_{CES}	t_{fi}
600 V	2.0 V	140 ns
600 V	2.5 V	70 ns

Symbol	Test Conditions	Maximum Ratings	
V_{CES}	$T_J = 25^\circ\text{C}$ to 150°C	600	V
V_{CGR}	$T_J = 25^\circ\text{C}$ to 150°C ; $R_{GE} = 1\text{ M}\Omega$	600	V
V_{GES}	Continuous	± 20	V
V_{GEM}	Transient	± 30	V
I_{C25}	$T_C = 25^\circ\text{C}$	55	A
I_{C90}	$T_C = 90^\circ\text{C}$	30	A
I_{CM}	$T_C = 25^\circ\text{C}$, 1 ms	110	A
SSOA (RBSOA)	$V_{GE} = 15\text{ V}$, $T_J = 125^\circ\text{C}$, $R_G = 2.7\ \Omega$ Clamped inductive load, $V_{CC} = 0.8 V_{CES}$	$I_{CM} = 60$ @ $0.8 V_{CES}$	A
t_{SC} (SCSOA)	$V_{GE} = 15\text{ V}$, $V_{CE} = 360\text{ V}$, $T_J = 125^\circ\text{C}$ $R_G = 33\ \Omega$, non repetitive	10	μs
P_c	$T_C = 25^\circ\text{C}$	200	W
T_J		-55 ... +150	$^\circ\text{C}$
T_{JM}		150	$^\circ\text{C}$
T_{stg}		-55 ... +150	$^\circ\text{C}$
M_d	Mounting torque	(TO-247)	1.13/10 Nm/lb.in.
Weight		TO-247	6 g
		TO-268	4 g
Maximum lead temperature for soldering 1.6 mm (0.062 in.) from case for 10 s		300	$^\circ\text{C}$

TO-247 AD (IXSH)

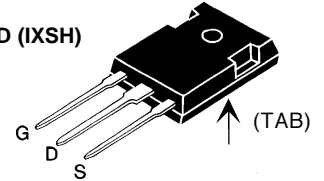

TO-268 (D3) (IXST)

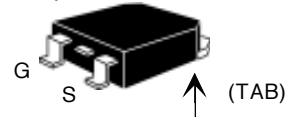

G = Gate
S = Source

TAB = Drain

Features

- International standard packages
- Short Circuit SOA capability
- High frequency IGBT
- New generation HDMOS™ process

Applications

- AC motor speed control
- DC servo and robot drives
- DC choppers
- Uninterruptible power supplies (UPS)
- Switch-mode and resonant-mode power supplies

Advantages

- Easy to mount with 1 screw (isolated mounting screw hole)
- Surface mountable, high power case style
- Reduce assembly time and cost
- High power density

Symbol	Test Conditions	Characteristic Values ($T_J = 25^\circ\text{C}$, unless otherwise specified)		
		min.	typ.	max.
BV_{CES}	$I_C = 250\ \mu\text{A}$, $V_{GE} = 0\text{ V}$	600		V
$V_{GE(th)}$	$I_C = 2.5\text{ mA}$, $V_{CE} = V_{GE}$	4		V
I_{CES}	$V_{CE} = 0.8 V_{CES}$ $V_{GE} = 0\text{ V}$	$T_J = 25^\circ\text{C}$		100 μA
		$T_J = 125^\circ\text{C}$		1 mA
I_{GES}	$V_{CE} = 0\text{ V}$, $V_{GE} = \pm 20\text{ V}$			$\pm 100\text{ nA}$
$V_{CE(sat)}$	$V_{GE} = 15\text{ V}$; $I_C = I_{C90}$	30N60B		2.0 V
		30N60C		2.5 V

Symbol	Test Conditions	Characteristic Values ($T_J = 25^\circ\text{C}$, unless otherwise specified)			
		min.	typ.	max.	
g_{fs}	$I_C = I_{C90}$; $V_{CE} = 10\text{ V}$, Pulse test, $t \leq 300\ \mu\text{s}$, duty cycle $\leq 2\%$	10		S	
C_{ies}			3100	pF	
C_{oes}	$V_{CE} = 25\text{ V}$, $V_{GE} = 0\text{ V}$, $f = 1\text{ MHz}$		240	pF	
C_{res}			30	pF	
Q_g			100	nC	
Q_{ge}	$I_C = I_{C90}$, $V_{GE} = 15\text{ V}$, $V_{CE} = 0.5 V_{CES}$		30	nC	
Q_{gc}			38	nC	
$t_{d(on)}$			30	ns	
t_{ri}	Inductive load, $T_J = 25^\circ\text{C}$		30	ns	
$t_{d(off)}$	$I_C = I_{C90}$, $V_{GE} = 15\text{ V}$ $V_{CE} = 0.8 V_{CES}$, $R_G = 4.7\ \Omega$	30N60B	150	270	ns
t_{fi}	Note 1	30N60C	90	150	ns
		30N60B	140	270	ns
		30N60C	70	120	ns
E_{off}		30N60B	1.5	2.5	mJ
		30N60C	0.7	1.2	mJ
$t_{d(on)}$	Inductive load, $T_J = 125^\circ\text{C}$		35	ns	
t_{ri}			35	ns	
E_{on}	$I_C = I_{C90}$, $V_{GE} = 15\text{ V}$ $V_{CE} = 0.8 V_{CES}$, $R_G = 4.7\ \Omega$		0.5	mJ	
$t_{d(off)}$	Note 1	30N60B	270	ns	
		30N60C	150	ns	
t_{fi}		30N60B	250	ns	
		30N60C	140	ns	
E_{off}		30N60B	2.5	mJ	
		30N60C	1.2	mJ	
R_{thJC}				0.62	K/W
R_{thCK}	(TO-247)		0.25	K/W	

Notes: 1. Switching times may increase for V_{CE} (Clamp) $> 0.8 V_{CES}$, higher T_J or increased R_G .

Min Recommended Footprint

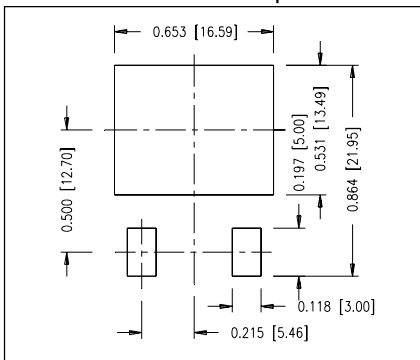

TO-247 AD Outline

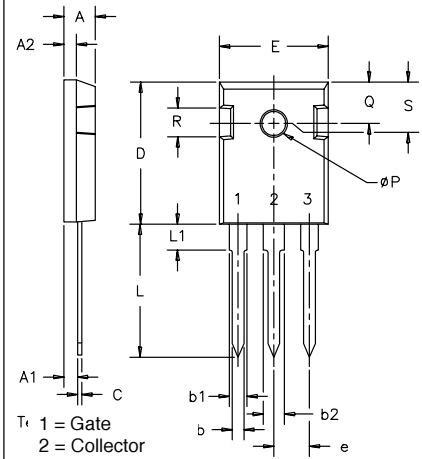

SYM	INCHES		MILLIMETERS	
	MIN	MAX	MIN	MAX
A	.185	.209	4.7	5.3
A1	.087	.102	2.2	2.54
A2	.059	.098	2.2	2.6
b	.040	.055	1.0	1.4
b1	.065	.084	1.65	2.13
b2	.113	.123	2.87	3.12
C	.016	.031	.4	.8
D	.819	.845	20.80	21.46
E	.610	.640	15.75	16.26
e	.215 BSC		5.45 BSC	
L	.780	.800	19.81	20.32
L1			1.77	4.50
ϕP	.140	.144	3.55	3.65
Q	.212	.244	5.4	6.2
R	.170	.216	4.32	5.49
S			.242 BSC	

TO-268 Outline

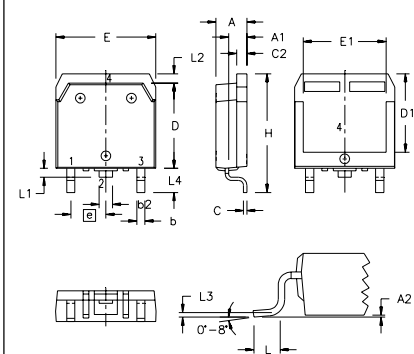

SYM	INCHES		MILLIMETERS	
	MIN	MAX	MIN	MAX
A	.193	.201	4.90	5.10
A1	.106	.114	2.70	2.90
A2	.001	.010	0.02	0.25
b	.045	.057	1.15	1.45
b2	.075	.083	1.90	2.10
C	.016	.026	0.40	0.65
C2	.057	.063	1.45	1.60
D	.543	.551	13.80	14.00
D1	.488	.500	12.40	12.70
E	.624	.632	15.85	16.05
E1	.524	.535	13.30	13.60
e	.215 BSC		5.45 BSC	
H	.736	.752	18.70	19.10
L	.094	.106	2.40	2.70
L1	.047	.055	1.20	1.40
L2	.039	.045	1.00	1.15
L3	.010 BSC		0.25 BSC	
L4	.150	.161	3.80	4.10

IXYS reserves the right to change limits, test conditions, and dimensions.

IXYS MOSFETS and IGBTs are covered by one or more of the following U.S. patents: 4,835,592 4,881,106 5,017,508 5,049,961 5,187,117 5,486,715
4,850,072 4,931,844 5,034,796 5,063,307 5,237,481 5,381,025

Fig.1 Saturation Characteristics

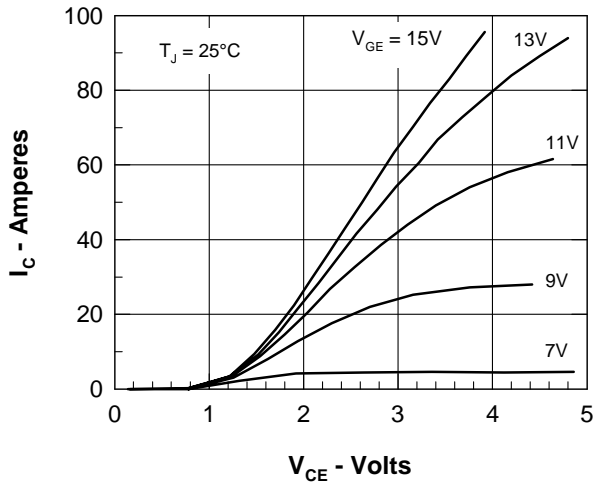

Fig.2 Output Characteristics

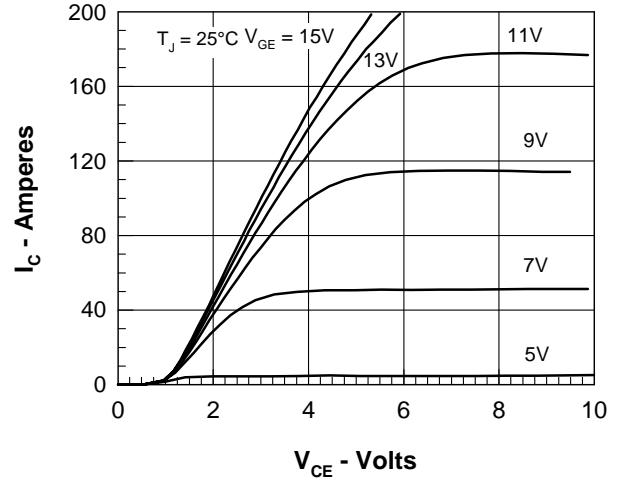

Fig.3 Collector-Emitter Voltage vs. Gate-Emitter Voltage

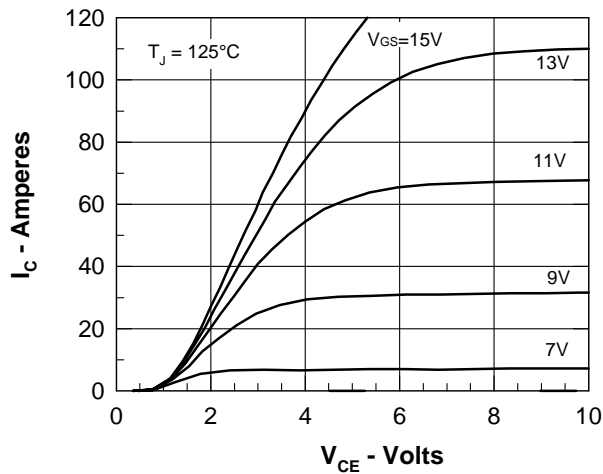

Fig.4 Temperature Dependence of Output Saturation Voltage

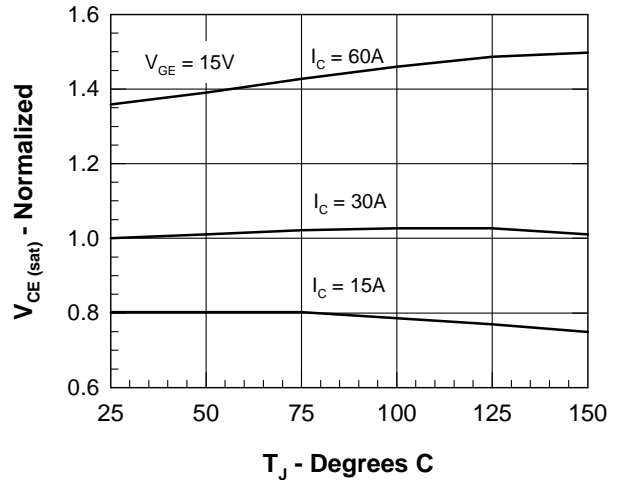

Fig.5 Input Admittance

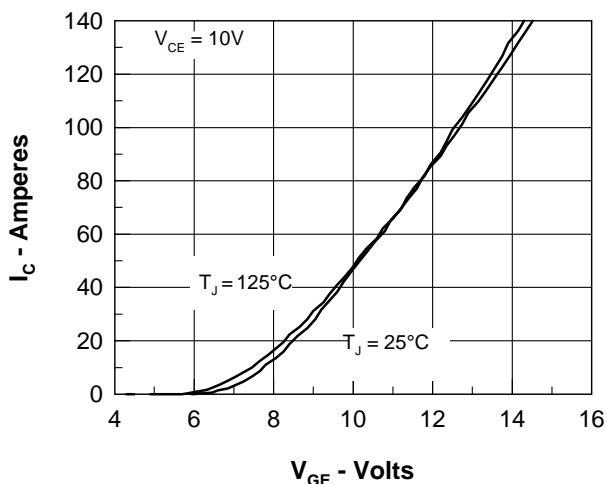

Fig.6 Temperature Dependence of Breakdown and Threshold Voltage

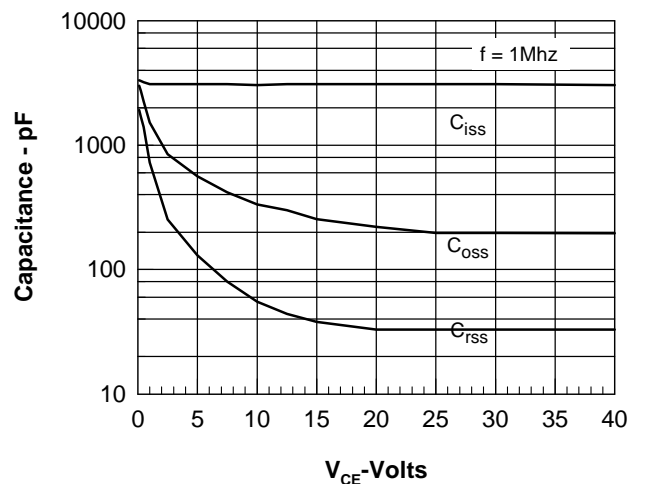

Fig.7 Turn-Off Energy per Pulse and Fall Time on Collector Current

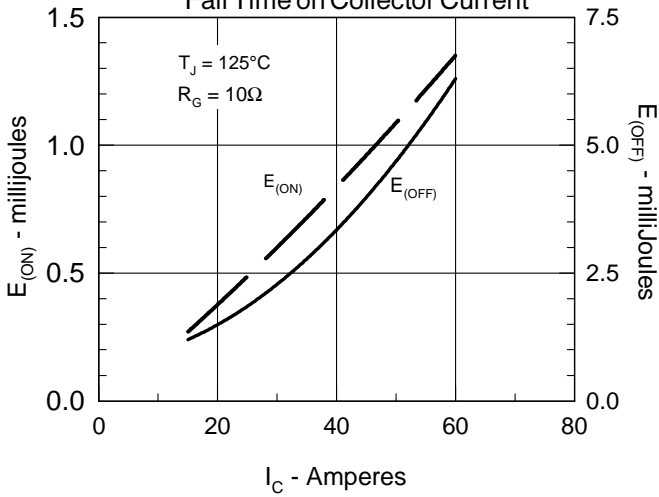

Fig.8 Dependence of Turn-Off Energy Per Pulse and Fall Time on R_G

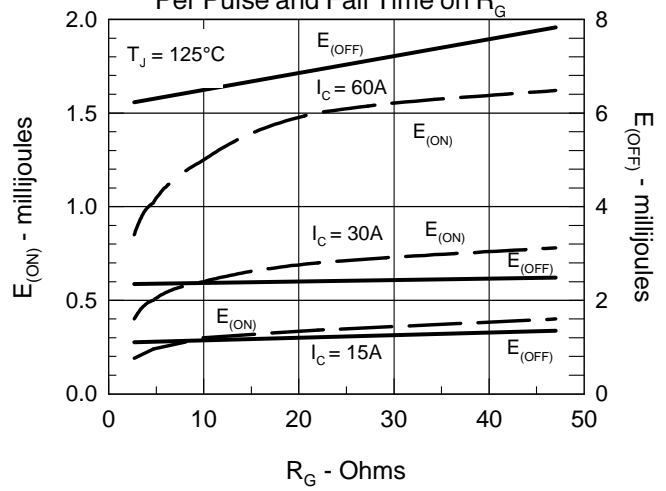

Fig.9 Gate Charge Characteristic Curve

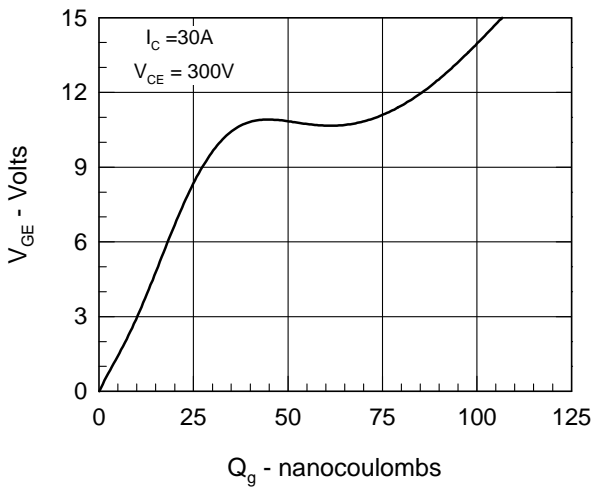

Fig.10 Turn-Off Safe Operating Area

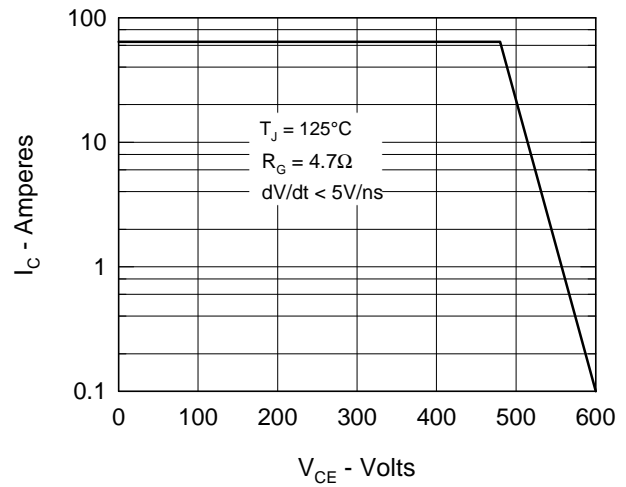
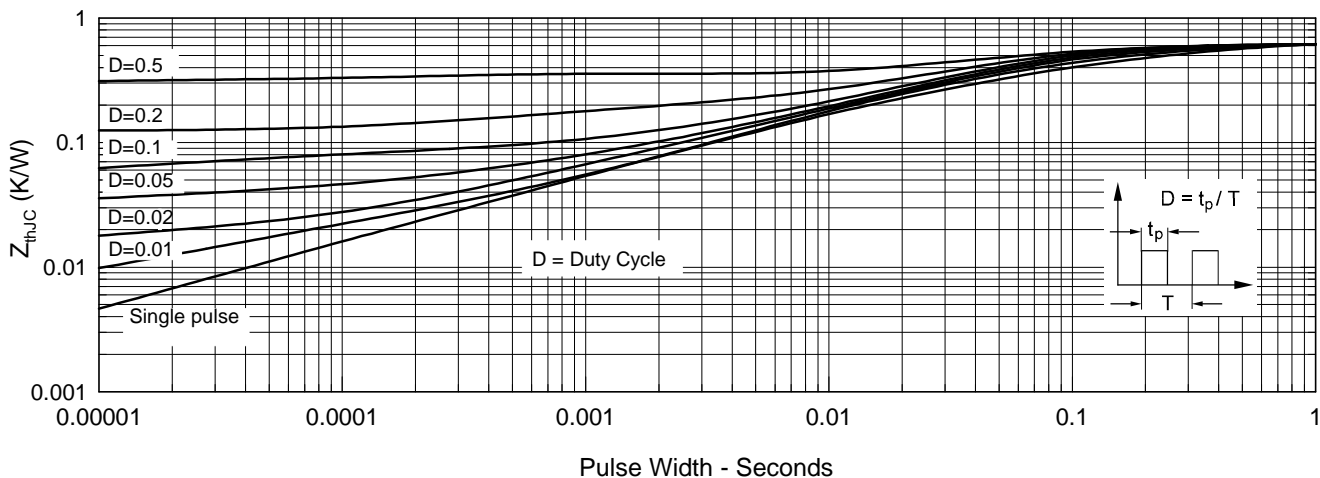

Fig.11 Transient Thermal Impedance



IXYS reserves the right to change limits, test conditions, and dimensions.

IXYS MOSFETS and IGBTs are covered by one or more of the following U.S. patents: 4,835,592 4,881,106 5,017,508 5,049,961 5,187,117 5,486,715
4,850,072 4,931,844 5,034,796 5,063,307 5,237,481 5,381,025

This datasheet has been downloaded from:

www.DatasheetCatalog.com

Datasheets for electronic components.



LittleDiode supplies new, hard to find or obsolete electronic components and semiconductors all over the world.

With over two million different components listed you are sure to find the part you need.

Feel free to visit us today at our online store:

LittleDiode.com

Looking forward to providing you with the best possible service.