

HiPerFET™ Power MOSFETs Q2-Class

IXFK 38N80Q2
IXFN 38N80Q2
IXFX 38N80Q2

$V_{DSS} = 800\text{ V}$
 $I_{D25} = 38\text{ A}$
 $R_{DS(on)} = 220\text{ m}\Omega$

$t_{rr} \leq 250\text{ ns}$

N-Channel Enhancement Mode
Avalanche Rated, High dv/dt, Low Q_g
Low intrinsic R_g

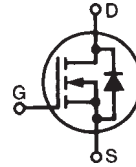

Preliminary Data Sheet

Symbol	Test Conditions	Maximum Ratings	
V_{DSS}	$T_J = 25^\circ\text{C}$ to 150°C	800	V
V_{DGR}	$T_J = 25^\circ\text{C}$ to 150°C ; $R_{GS} = 1\text{ M}\Omega$	800	V
V_{GS}	Continuous	± 30	V
V_{GSM}	Transient	± 40	V
I_{D25}	$T_C = 25^\circ\text{C}$	38	A
I_{DM}	$T_C = 25^\circ\text{C}$, pulse width limited by T_{JM}	150	A
I_{AR}	$T_C = 25^\circ\text{C}$	38	A
E_{AR}	$T_C = 25^\circ\text{C}$	75	mJ
E_{AS}	$T_C = 25^\circ\text{C}$	4.0	J
dv/dt	$I_S \leq I_{DM}$, $di/dt \leq 100\text{ A}/\mu\text{s}$, $V_{DD} \leq V_{DSS}$, $T_J \leq 150^\circ\text{C}$, $R_g = 2\ \Omega$	20	V/ns
P_D	$T_C = 25^\circ\text{C}$	735	W
T_J		-55 ... +150	$^\circ\text{C}$
T_{JM}		150	$^\circ\text{C}$
T_{stg}		-55 ... +150	$^\circ\text{C}$
T_L	1.6mm (0.063in) from case for 10s (Plus247, TO-264)	300	$^\circ\text{C}$
V_{ISOL}	50/60Hz, RMS $t=1\text{ min}$ $I_{ISOL} < 1\text{ mA}$ $t=1\text{ s}$	SOT-227B 2500	V~
		3000	V~
M_d	Mounting torque Terminal torque	TO-264 SOT-227B	0.9/8 Nm/lb.in. 1.5/13 Nm/lb.in.
F_c	Mounting force	PLUS-247	22...130/5...30 N/lb
Weight		PLUS247	g
		TO-264	10 g
		SOT-227B	30 g

Symbol	Test Conditions	Characteristic Values ($T_J = 25^\circ\text{C}$, unless otherwise specified)		
		min.	typ.	max.
V_{DSS}	$V_{GS} = 0\text{ V}$, $I_D = 3\text{ mA}$	800		V
$V_{GS(th)}$	$V_{DS} = V_{GS}$, $I_D = 8\text{ mA}$	2.0		V
I_{GSS}	$V_{GS} = \pm 30\text{ V}_{DC}$, $V_{DS} = 0$			$\pm 200\text{ nA}$
I_{DSS}	$V_{DS} = V_{DSS}$, $T_J = 25^\circ\text{C}$ $V_{GS} = 0\text{ V}$, $T_J = 125^\circ\text{C}$			50 μA
				2 mA
$R_{DS(on)}$	$V_{GS} = 10\text{ V}$, $I_D = 0.5 \cdot I_{D25}$ Pulse test, $t \leq 300\ \mu\text{s}$, duty cycle $d \leq 2\%$			220 m Ω

PLUS247™ (IXFX)

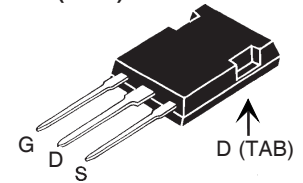

TO-264 AA (IXFK)

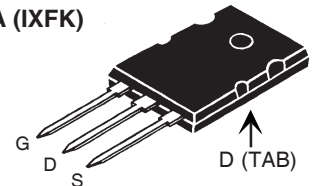

miniBLOC, SOT-227 B (IXFN)

E153432

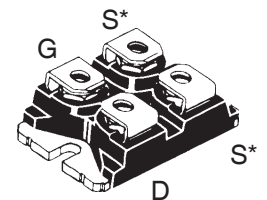

* Either Source terminal can be used as main or Kelvin source terminal

G = Gate
S = Source
D = Drain
TAB = Drain

Features

- Double metal process for low gate resistance
- International standard packages
- Epoxy meet UL 94 V-0, flammability classification
- Avalanche energy and current rated
- Fast intrinsic Rectifier
- miniBLOC package version with Aluminum Nitrate isolation

Advantages

- Easy to mount
- Space savings
- High power density

Symbol	Test Conditions	Characteristic Values ($T_J = 25^\circ\text{C}$, unless otherwise specified)		
		min.	typ.	max.
g_{fs}	$V_{DS} = 10\text{ V}; I_D = 0.5 \cdot I_{D25}$, pulse test	25	37	S
C_{iss}	$V_{GS} = 0\text{ V}, V_{DS} = 25\text{ V}, f = 1\text{ MHz}$		8340	pF
C_{oss}			890	pF
C_{rss}			175	pF
$t_{d(on)}$	$V_{GS} = 10\text{ V}, V_{DS} = 0.5 \cdot V_{DSS}, I_D = 0.5 \cdot I_{D25}$ $R_G = 1.0\ \Omega$ (External),		20	ns
t_r			16	ns
$t_{d(off)}$			60	ns
t_f			12	ns
$Q_{g(on)}$	$V_{GS} = 10\text{ V}, V_{DS} = 0.5 \cdot V_{DSS}, I_D = 0.5 \cdot I_{D25}$		190	nC
Q_{gs}			44	nC
Q_{gd}			88	nC
R_{thJC}	TO-264		0.17	K/W
R_{thCK}			0.15	K/W

PLUS 247™ Outline

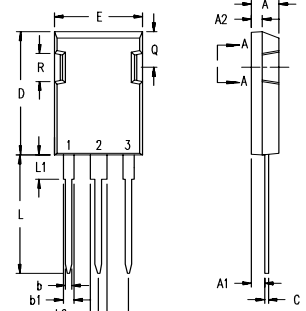

Terminals: 1 - Gate
2 - Drain (Collector)
3 - Source (Emitter)
4 - Drain (Collector)

Dim.	Millimeter		Inches	
	Min.	Max.	Min.	Max.
A	4.83	5.21	.190	.205
A ₁	2.29	2.54	.090	.100
A ₂	1.91	2.16	.075	.085
b	1.14	1.40	.045	.055
b ₁	1.91	2.13	.075	.084
b ₂	2.92	3.12	.115	.123
C	0.61	0.80	.024	.031
D	20.80	21.34	.819	.840
E	15.75	16.13	.620	.635
e	5.45 BSC		.215 BSC	
L	19.81	20.32	.780	.800
L1	3.81	4.32	.150	.170
Q	5.59	6.20	.220	0.244
R	4.32	4.83	.170	.190

Source-Drain Diode

Symbol	Test Conditions	Characteristic Values ($T_J = 25^\circ\text{C}$, unless otherwise specified)		
		min.	typ.	max.
I_S	$V_{GS} = 0\text{ V}$			38 A
I_{SM}	Repetitive; pulse width limited by T_{JM}			150 A
V_{SD}	$I_F = I_S, V_{GS} = 0\text{ V}$, Pulse test, $t \leq 300\ \mu\text{s}$, duty cycle $d \leq 2\%$			1.5 V
t_{rr}	$I_F = 25\text{ A}, -di/dt = 100\text{ A}/\mu\text{s}, V_R = 100\text{ V}$			250 ns
Q_{RM}			1	μC
I_{RM}			10	A

TO-264 AA Outline

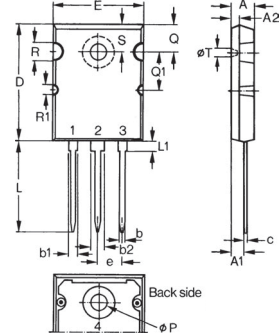

Dim.	Millimeter		Inches	
	Min.	Max.	Min.	Max.
A	4.82	5.13	.190	.202
A1	2.54	2.89	.100	.114
A2	2.00	2.10	.079	.083
b	1.12	1.42	.044	.056
b1	2.39	2.69	.094	.106
b2	2.90	3.09	.114	.122
c	0.53	0.83	.021	.033
D	25.91	26.16	1.020	1.030
E	19.81	19.96	.780	.786
e	5.46 BSC		.215 BSC	
J	0.00	0.25	.000	.010
K	0.00	0.25	.000	.010
L	20.32	20.83	.800	.820
L1	2.29	2.59	.090	.102
P	3.17	3.66	.125	.144
Q	6.07	6.27	.239	.247
Q1	8.38	8.69	.330	.342
R	3.81	4.32	.150	.170
R1	1.78	2.29	.070	.090
S	6.04	6.30	.238	.248
T	1.57	1.83	.062	.072

SOT-227B miniBLOC Outline

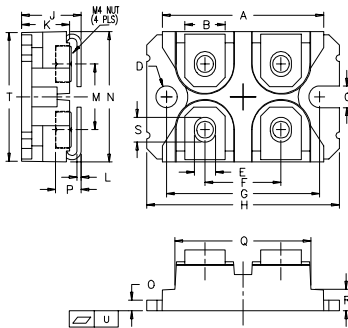

SYM	INCHES		MILLIMETERS	
	MIN	MAX	MIN	MAX
A	1.240	1.255	31.50	31.88
B	.307	.323	7.80	8.20
C	.161	.169	4.09	4.29
D	.161	.169	4.09	4.29
E	.161	.169	4.09	4.29
F	.587	.595	14.91	15.11
G	1.186	1.193	30.12	30.30
H	1.496	1.505	38.00	38.23
J	.460	.481	11.68	12.22
K	.351	.378	8.92	9.60
L	.030	.033	0.76	0.84
M	.496	.506	12.60	12.85
N	.990	1.001	25.15	25.42
O	.078	.084	1.98	2.13
P	.195	.235	4.95	5.97
Q	1.045	1.059	26.54	26.90
R	.155	.174	3.94	4.42
S	.186	.191	4.72	4.85
T	.968	.987	24.59	25.07
U	-.002	.004	-0.05	0.1

IXYS reserves the right to change limits, test conditions, and dimensions.

IXYS MOSFETs and IGBTs are covered by one or more of the following U.S. patents:	4,835,592	4,931,844	5,049,961	5,237,481	6,162,665	6,404,065 B1	6,683,344	6,727,585
	4,850,072	5,017,508	5,063,307	5,381,025	6,259,123 B1	6,534,343	6,710,405 B2	6,759,692
	4,881,106	5,034,796	5,187,117	5,486,715	6,306,728 B1	6,583,505	6,710,463	

Fig. 1. Output Characteristics @ 25°C

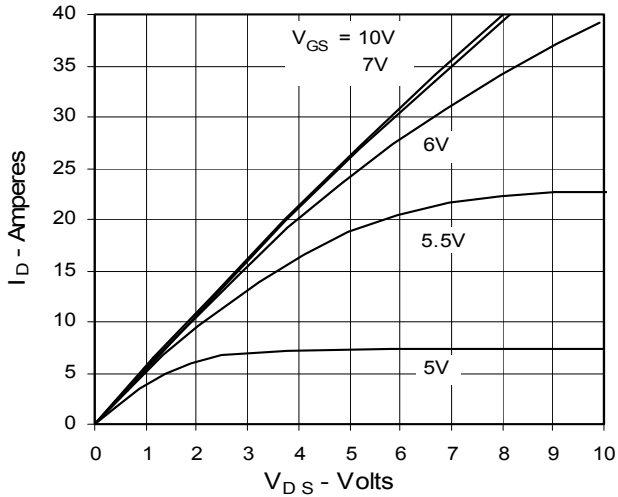

Fig. 2. Extended Output Characteristics @ 25°C

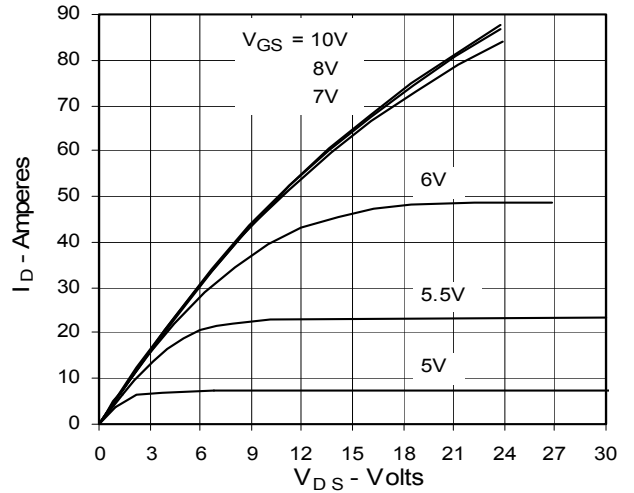

Fig. 3. Output Characteristics @ 125°C

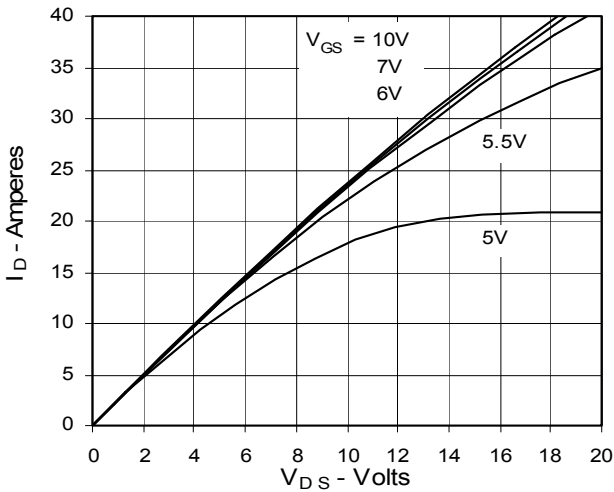

Fig. 4. $R_{DS(on)}$ Normalized to 0.5 I_{D25} Value vs. Junction Temperature

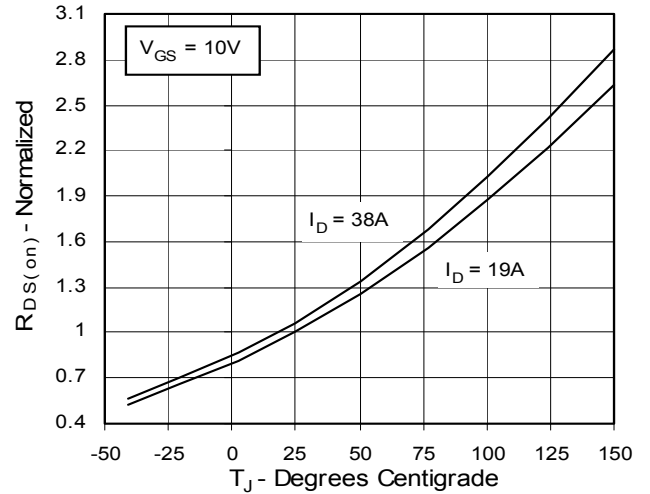

Fig. 5. $R_{DS(on)}$ Normalized to 0.5 I_{D25} Value vs. I_D

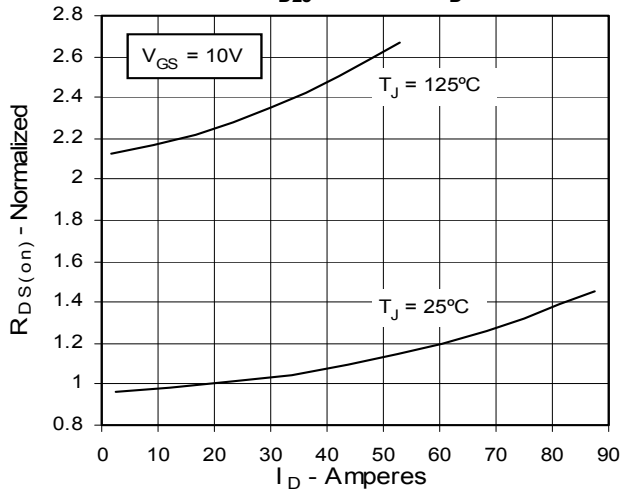

Fig. 6. Drain Current vs. Case Temperature

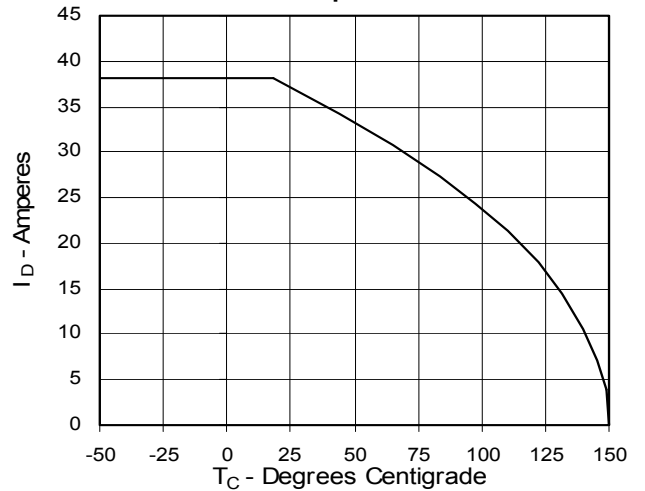

Fig. 7. Input Admittance

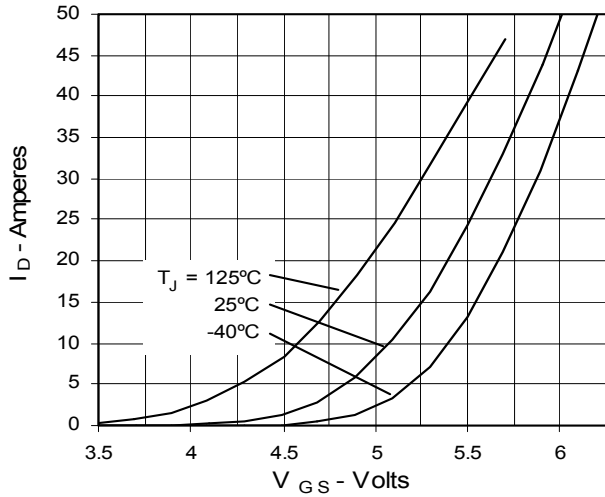

Fig. 8. Transconductance

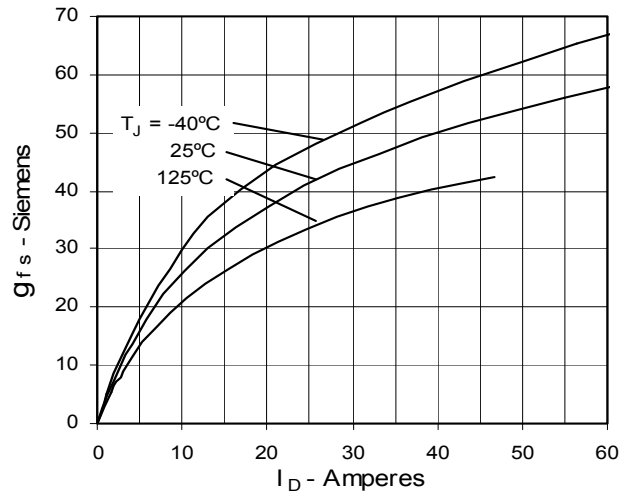

Fig. 9. Source Current vs. Source-To-Drain Voltage

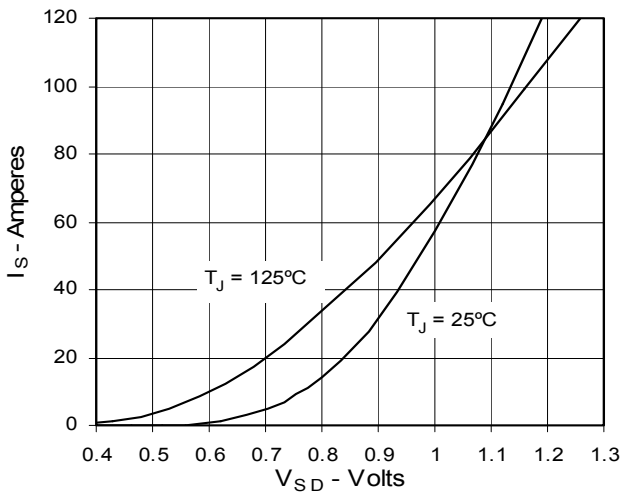

Fig. 10. Gate Charge

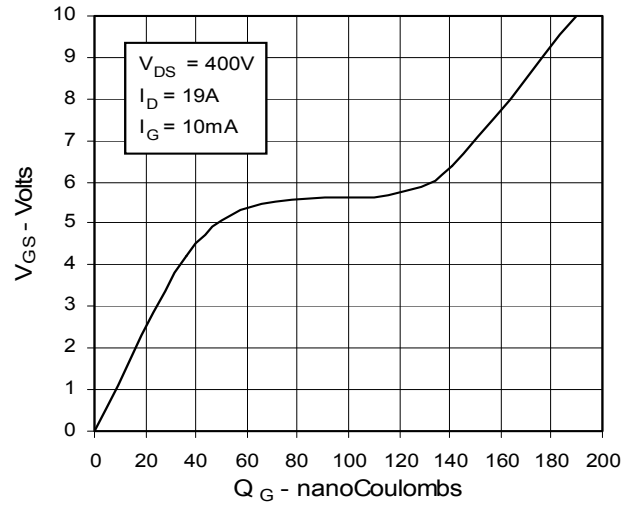

Fig. 11. Capacitance

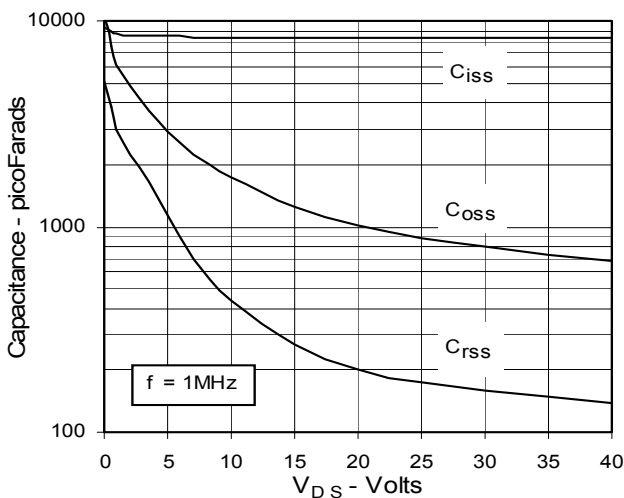

Fig. 12. Forward-Bias Safe Operating Area

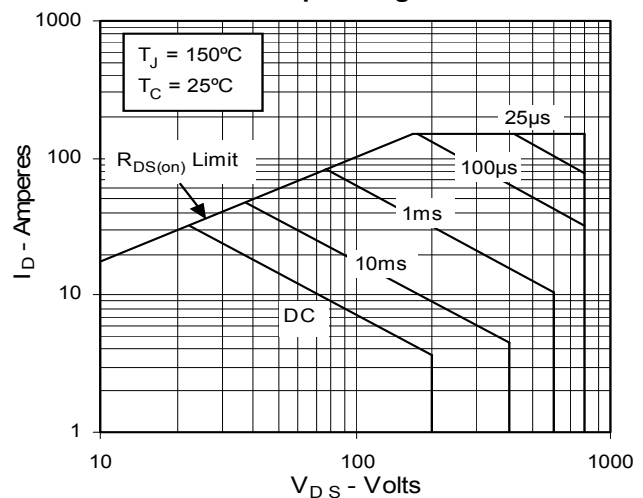
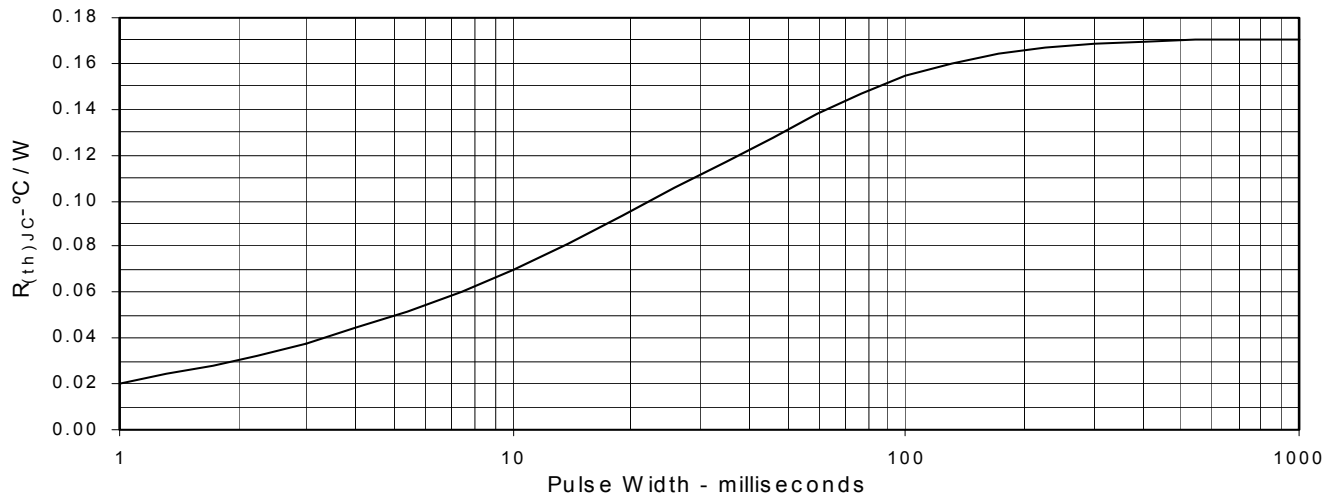

Fig. 13. Maximum Transient Thermal Resistance





LittleDiode supplies new, hard to find or obsolete electronic components and semiconductors all over the world.

With over two million different components listed you are sure to find the part you need.

Feel free to visit us today at our online store:

LittleDiode.com

Looking forward to providing you with the best possible service.