

# AC05DGM to AC05FGM

## 5 A MOLD TRIAC

### PACKAGE DIMENSIONS (Unit: mm)

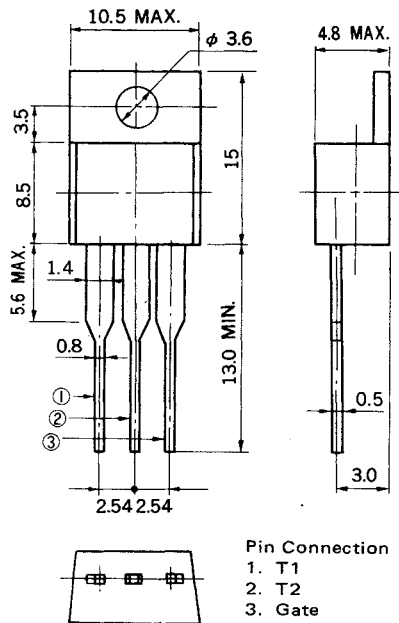

The AC05DGM to AC05FGM are all diffused mold type triac granted RMS On-state current 5 Amps, with rated voltages up to 600 volts.

### FEATURES

- 50 A Surge current
- TO-220AB mold package
- Low cost

### APPLICATIONS

- Motor speed control
- Lamp dimmer, Temperature controllers
- Various solid state switches, etc.

### MAXIMUM RATINGS

CHARACTERISTIC	SYMBOL	AC05DGM	AC05EGM	AC05FGM	UNIT	NOTE
Repetitive Peak off Voltage	$V_{DRM}$	400	500	600	V	
Non-repetitive Peak off Voltage	$V_{DSM}$	500	600	700	V	
RMS On-State Current	$I_T (RMS)$	5 ( $T_c = 107^\circ C$ )			A	See Fig. 11, 12
Peak Surge On-State Current	$I_{TSM}$	50 (50 Hz, Non-repetitive)			A	See Fig. 2
Fusing Current	$\int i^2 dt$	10 ( $1 ms \leq t \leq 10 ms$ )			$A^2 s$	
Peak Gate Power Dissipation	$P_{GM}$	3 ( $f \geq 50 Hz, Duty \leq 10\%$ )			W	
Average Gate Power Dissipation	$P_G (AV)$	0.3			W	
Peak Gate Current	$I_{FGM}$	$\pm 3$ ( $f \geq 50 Hz, Duty \leq 10\%$ )			A	
Junction Temperature	$T_j$	-40 to +125			$^\circ C$	
Storage Temperature	$T_{stg}$	-40 to +125			$^\circ C$	

ELECTRICAL CHARACTERISTICS ( $T_j = 25^\circ\text{C}$ )

CHARACTERISRIC	SYMBOL	TEST CONDITIONS	MIN.	TYP.	MAX.	UNIT	NOTE
Peak off-State Current	$I_{DRM}$	$T_j = 125^\circ\text{C}$ $V_{DM} = V_{DRM}$	—	—	1	mA	
On-State Voltage	$V_{TM}$	$I_{TM} = 5\text{ A}$	—	—	1.8	V	See Fig. 1
Gate Trigger Current	Trigger Mode I II III IV	$I_{GT}$ $V_{DM} = 12\text{ V}$ $R_L = 30\ \Omega$	—	—	10	mA	See Fig. 4
			—	—	—		
			—	—	10		
			—	—	10		
Gate Trigger Voltage	Trigger Mode I II III IV	$V_{GT}$ $V_{DM} = 12\text{ V}$ $R_L = 30\ \Omega$	—	—	1.5	V	See Fig. 4
			—	—	2.0		
			—	—	1.5		
			—	—	1.5		
Gate Non-Trigger Voltage	$V_{GD}$	$T_j = 125^\circ\text{C}$ , $V_{DM} = \frac{1}{2}V_{DRM}$	0.2	—	—	V	
Commutating dv/dt	$(dv/dt)\text{ C}$	$T_j = 125^\circ\text{C}$ $(di_T/dt)\text{ C} = -2.7\text{ A/ms}$ $V_D = 400\text{ V}$	5	—	—	V/ $\mu\text{s}$	
Holding Current	$I_H$	$V_D = 24\text{ V}$ , $I_{TM} = 5\text{ A}$	—	10	—	mA	
Thermal Resistance	$R_{th(j-c)}$	Junction to Case	—	—	3.0	$^\circ\text{C/W}$	See Fig. 13

Trigger Mode & Test Circuit

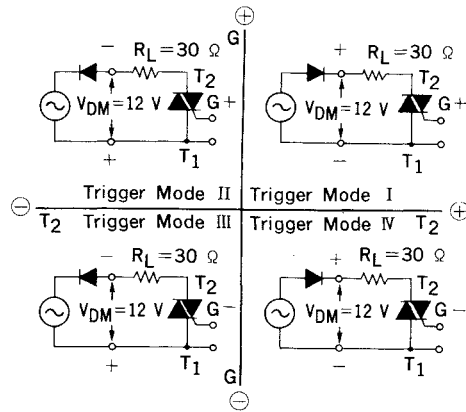

Fig. 1  $i_T - v_T$  CHARACTERISTIC

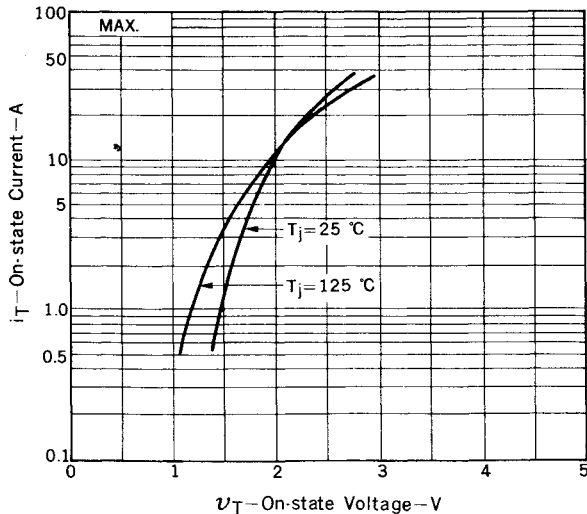

Fig. 2  $I_{TSM}$  RATING

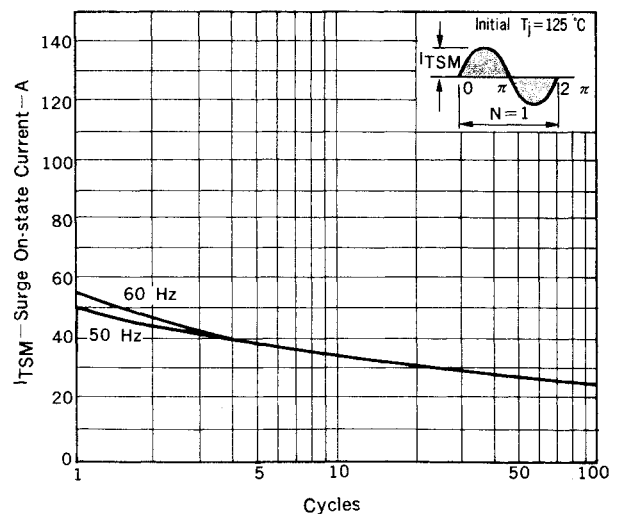

Fig. 3  $V_G - I_G$  RATING

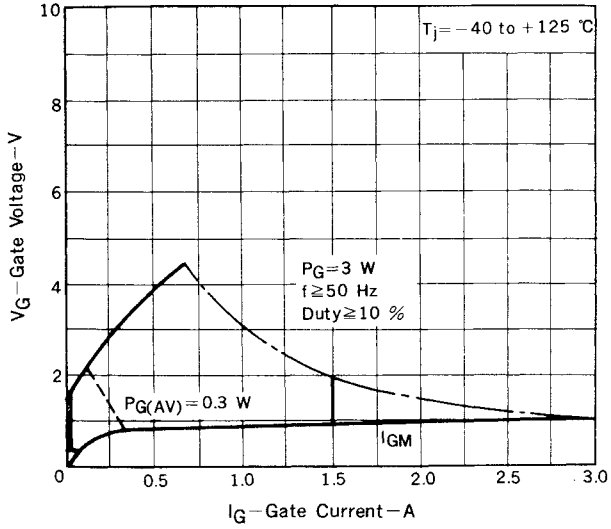

Fig. 4  $V_{GT} - I_{GT}$  CHARACTERISTIC

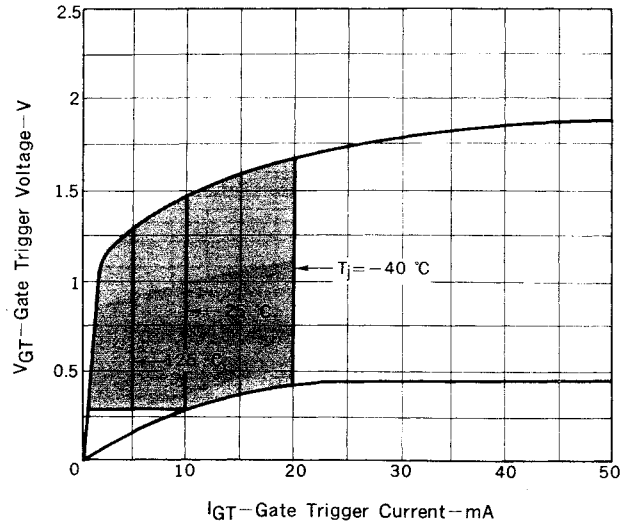

Fig. 5  $I_{GT} - T_a$  TYPICAL DISTRIBUTION

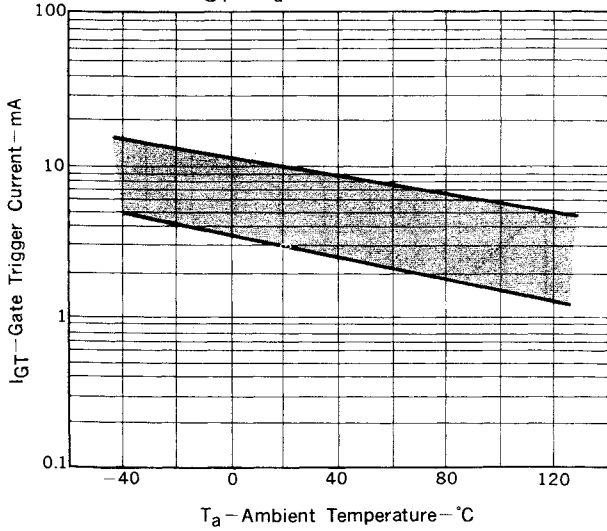

Fig. 6  $V_{GT} - T_a$  TYPICAL DISTRIBUTION

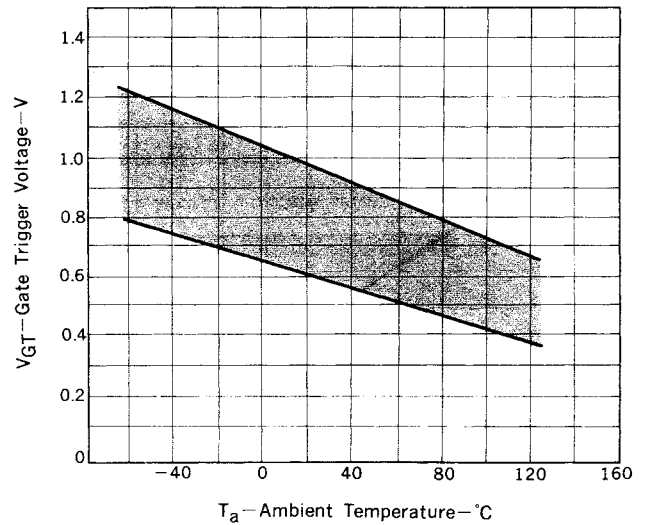

Fig. 7  $i_{GT} - \tau$  TYPICAL DISTRIBUTION

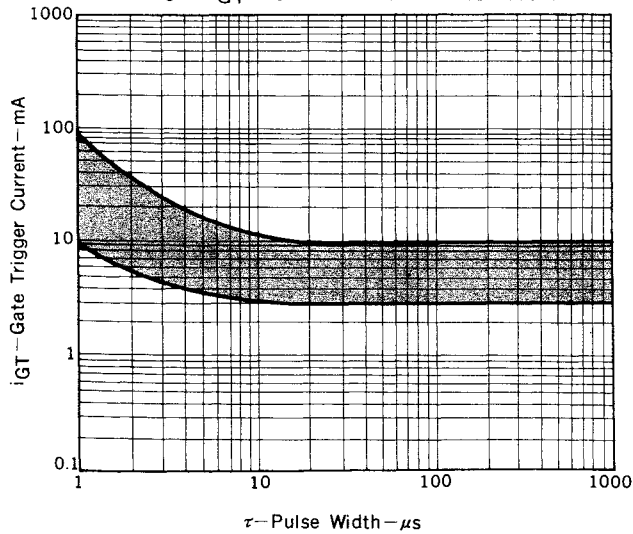

Fig. 8  $v_{GT} - \tau$  TYPICAL DISTRIBUTION

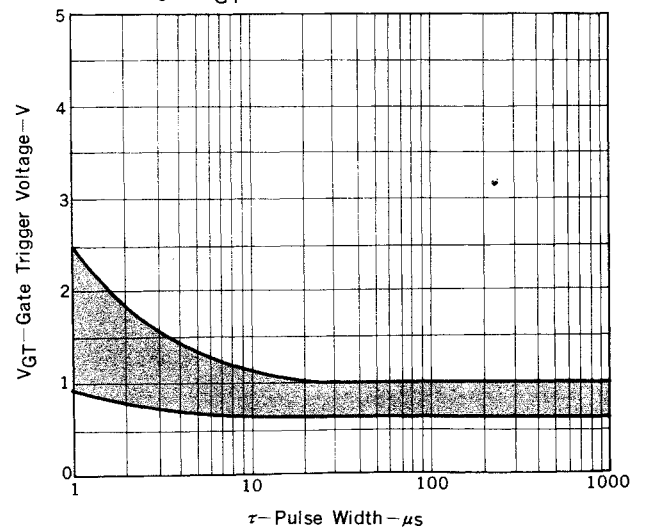

Fig. 9  $I_H - T_a$  TYPICAL DISTRIBUTION

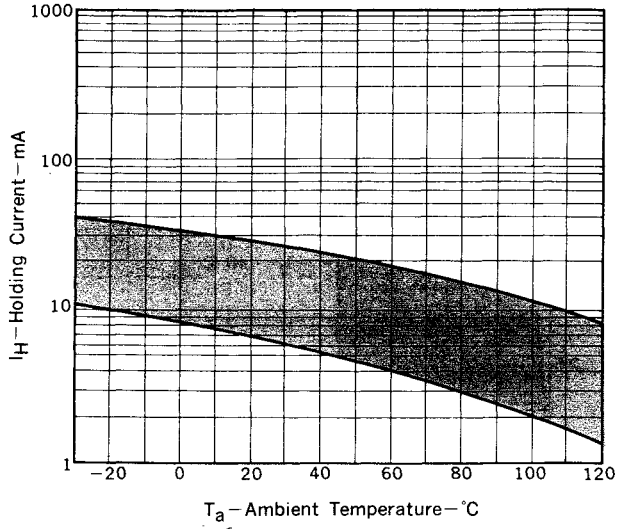

Fig. 10  $P_T(AV) - I_T(RMS)$  CHARACTERISTIC

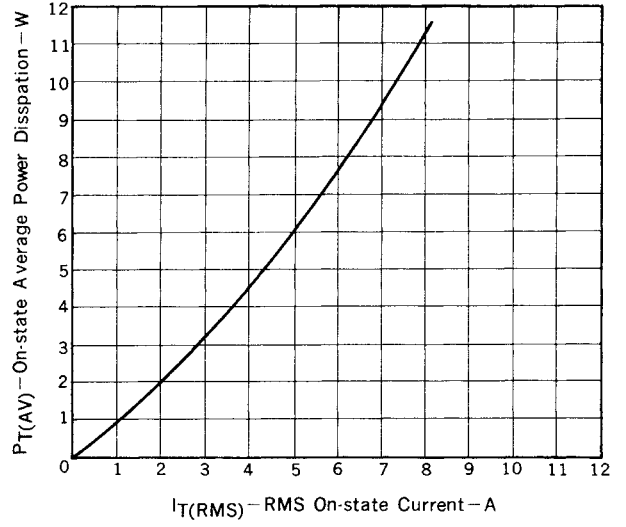

Fig. 11  $T_c - I_T(RMS)$  RATING

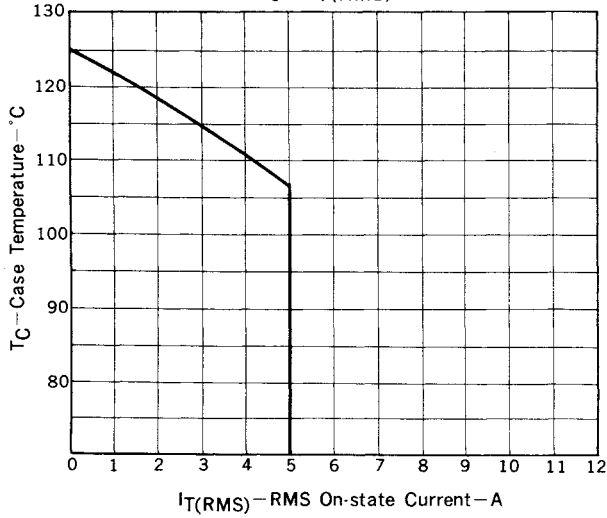

Fig. 12  $T_a - I_T(RMS)$  RATING

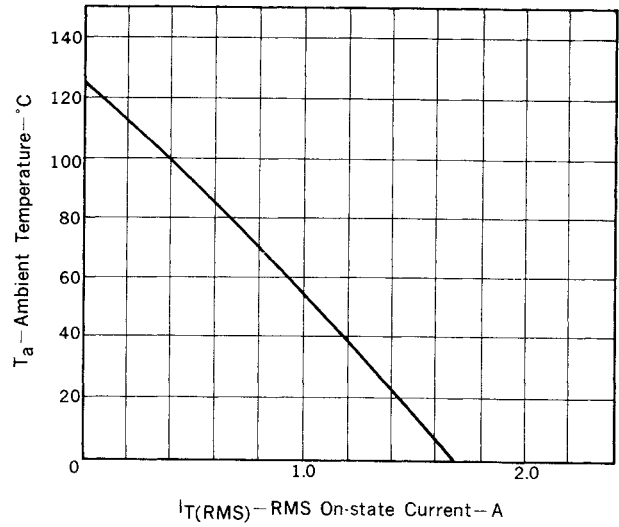
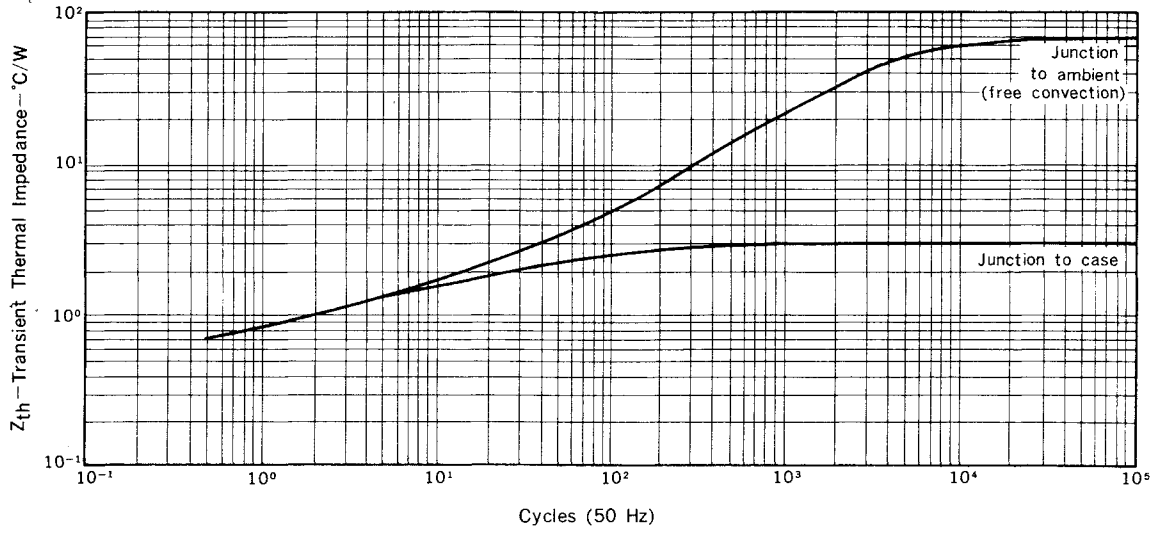

Fig. 13  $Z_{th}$  CHARACTERISTIC



---

## NEC Corporation

INTERNATIONAL ELECTRON DEVICES DIV.  
SUMITOMO MITA Building, 37-8,  
Shiba Gochome, Minato-ku, Tokyo 108, Japan  
Tel: Tokyo 456-3111  
Telex Address: NECTOK J22686  
Cable Address: NEC TOKYO

SC-1032  
APR.-25-85M  
Printed in Japan



LittleDiode supplies new, hard to find or obsolete electronic components and semiconductors all over the world.

With over two million different components listed you are sure to find the part you need.

Feel free to visit us today at our online store:

[LittleDiode.com](http://LittleDiode.com)

Looking forward to providing you with the best possible service.