

AC12DGM to AC12FGM

12 A MOLD TRIAC

PACKAGE DIMENSIONS (Unit: mm)

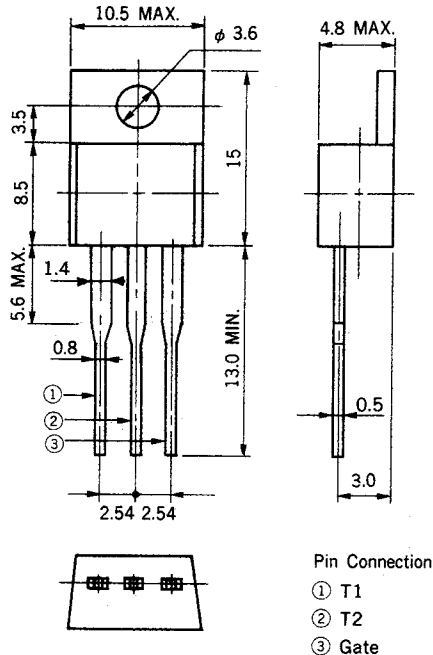

The AC12DGM to AC12FGM are all diffused mold type triac granted RMS On-state current 12 Amps, with rated voltages up to 600 volts.

FEATURES

- 100 A Surge Current
- TO-220AB mold package
- Low-cost

APPLICATIONS

- Motor speed control
- Lamp dimmer, Temperature controllers
- Various solid state switches, etc.

MAXIMUM RATINGS

CHARACTERISTIC	SYMBOL	AC12DGM	AC12EGM	AC12FGM	UNIT	NOTE
Repetitive Peak off Voltage	V_{DRM}	400	500	600	V	
Non-repetitive Peak off Voltage	V_{DSM}	500	600	700	V	
RMS On-State Current	I_T (RMS)	12 ($T_c = 98^\circ\text{C}$)			A	See Fig. 11, 12
Peak Surge On-State Current	I_{TSM}	100 (50 Hz, Non-repetitive)			A	See Fig. 2
Fusing Current	$\int i_T^2 dt$	45 ($1\text{ ms} \leq t \leq 10\text{ ms}$)			A^2s	
Peak Gate Power Dissipation	P_{GM}	5.0			W	
Average Gate Power Dissipation	P_G (AV)	0.5			W	
Peak Gate Current	I_{FGM}	± 3			A	
Junction Temperature	T_j	-40 to +125			$^\circ\text{C}$	
Storage Temperature	T_{stg}	-40 to +125			$^\circ\text{C}$	

ELECTRICAL CHARACTERISTICS ($T_j = 25^\circ\text{C}$)

CHARACTERISTIC		SYMBOL	TEST CONDITIONS	MIN.	TYP.	MAX.	UNIT	NOTE
Peak off-State Current		I_{DRM}	$T_j = 125^\circ\text{C}, V_{\text{DM}} = V_{\text{DRM}}$	—	—	2	mA	
On-State Voltage		V_{TM}	$I_{\text{TM}} = 10\text{ A}$	—	—	1.4	V	See Fig. 1
Gate Trigger Current	Trigger Mode I	I_{GT}	$V_{\text{DM}} = 12\text{ V}$ $R_L = 30\ \Omega$	—	—	30	mA	See Fig. 4
	II			—	—	80		
	III			—	—	30		
	IV			—	—	30		
Gate Trigger Voltage	Trigger Mode I	V_{GT}	$V_{\text{DM}} = 12\text{ V}$ $R_L = 30\ \Omega$	—	—	1.5	V	See Fig. 4
	II			—	—	2.0		
	III			—	—	1.5		
	IV			—	—	1.5		
Gate Non-Trigger Voltage		V_{GD}	$T_j = 125^\circ\text{C}$ $V_{\text{DM}} = 1/2 V_{\text{DRM}}$	0.3	—	—	V	
Commutating dv/dt		$(dv/dt)\text{ C}$	$T_j = 125^\circ\text{C}$ $(di_{\text{T}}/dt)\text{ C} = -6\text{ A/ms}$ $V_{\text{D}} = 400\text{ V}$	10	—	—	V/ μs	
Holding Current		I_{H}	$V_{\text{D}} = 24\text{ V}$	—	30	—	mA	
Thermal Resistance		$R_{\text{th}}(j-c)$	Junction to Case	—	—	1.8	$^\circ\text{C/W}$	See Fig. 13

Trigger Mode & Test Circuit

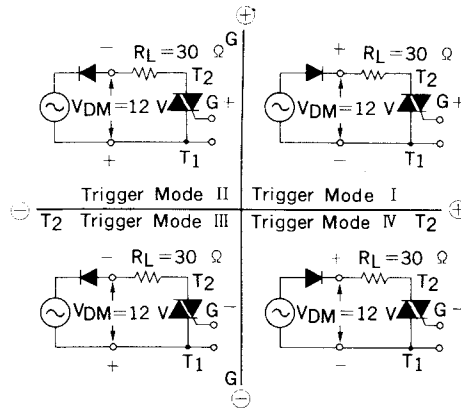

Fig. 1 $i_{\text{T}} - v_{\text{T}}$ CHARACTERISTIC

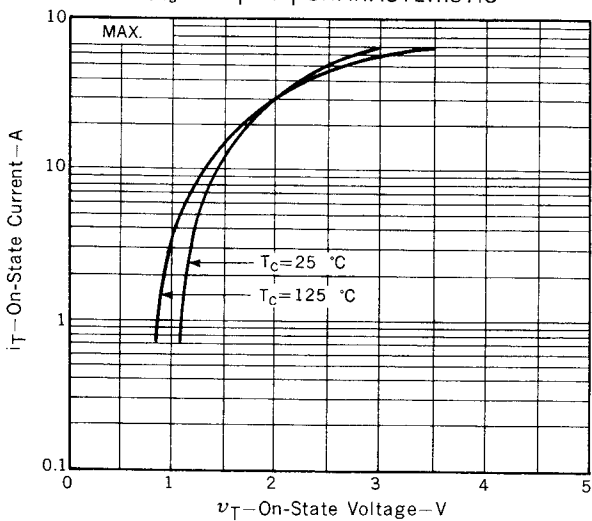

Fig. 2 I_{TSM} RATING

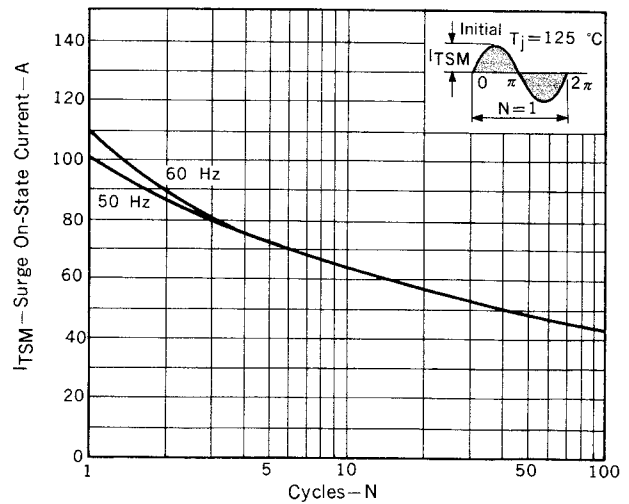

Fig. 3 $V_G - I_G$ RATING

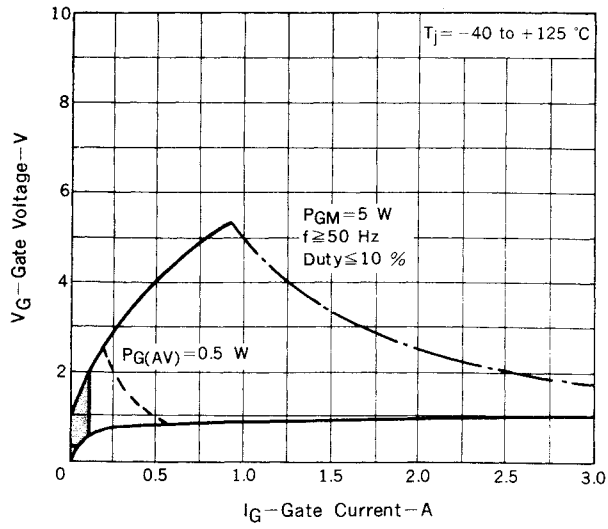

Fig. 4 $V_{GT} - I_{GT}$ CHARACTERISTIC

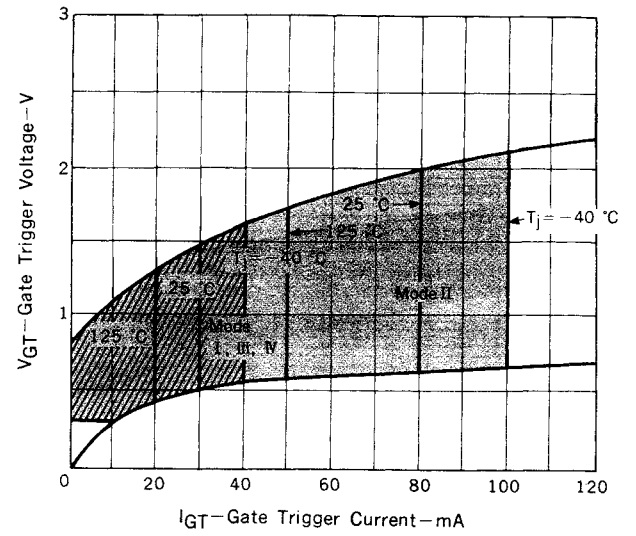

Fig. 5 $I_{GT} - T_a$ TYPICAL DISTRIBUTION

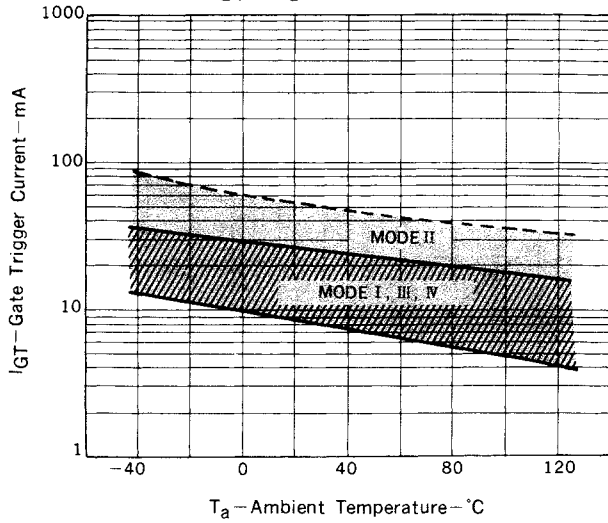

Fig. 6 $V_{GT} - T_a$ TYPICAL DISTRIBUTION

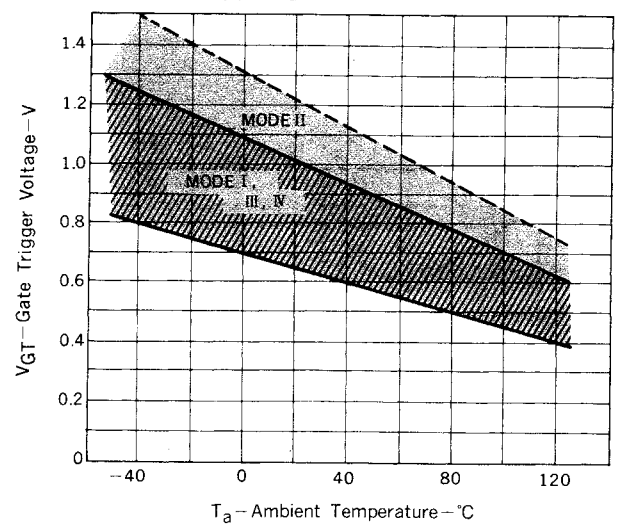

Fig. 7 $i_{GT} - \tau$ TYPICAL DISTRIBUTION

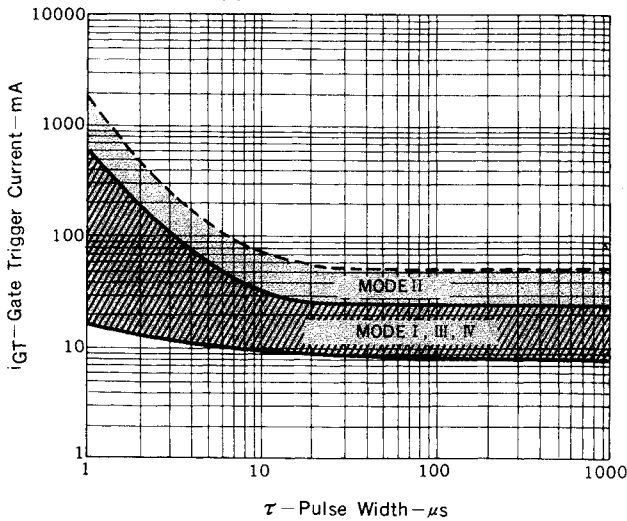

Fig. 8 $v_{GT} - \tau$ TYPICAL DISTRIBUTION

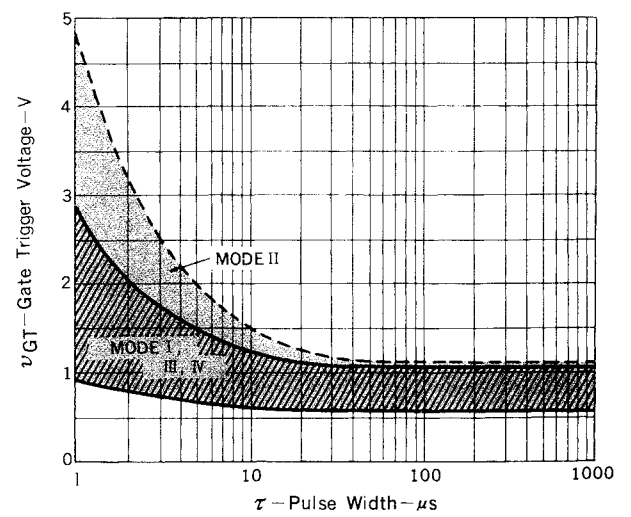

Fig. 9 $I_H - T_a$ TYPICAL DISTRIBUTION

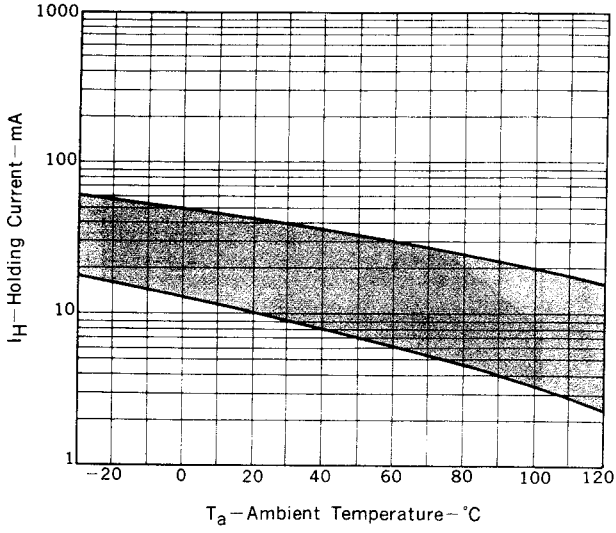

Fig. 10 $P_{T(AV)} - I_{T(RMS)}$ CHARACTERISTIC

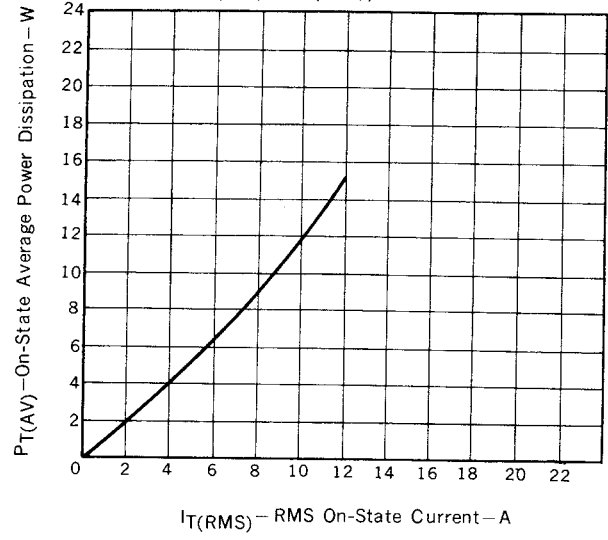

Fig. 11 $T_c - I_{T(RMS)}$ RATING

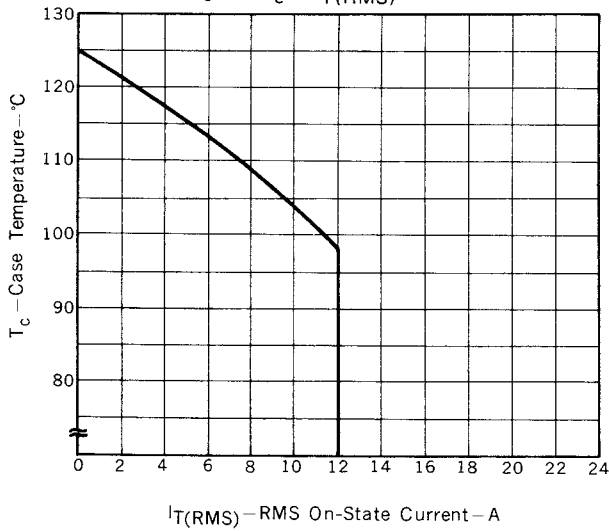

Fig. 12 $T_a - I_{T(RMS)}$ RATING

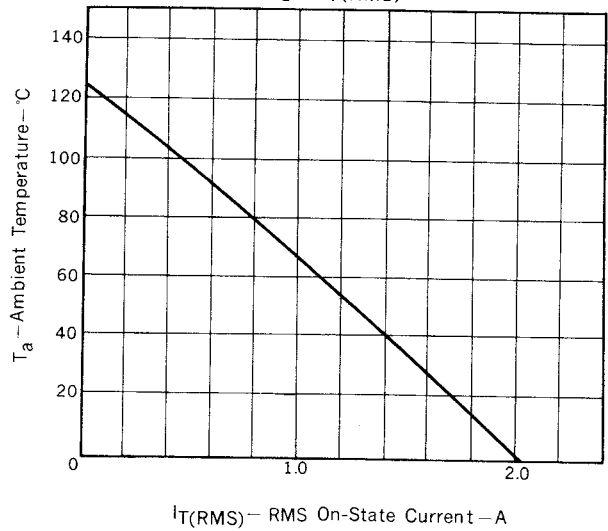
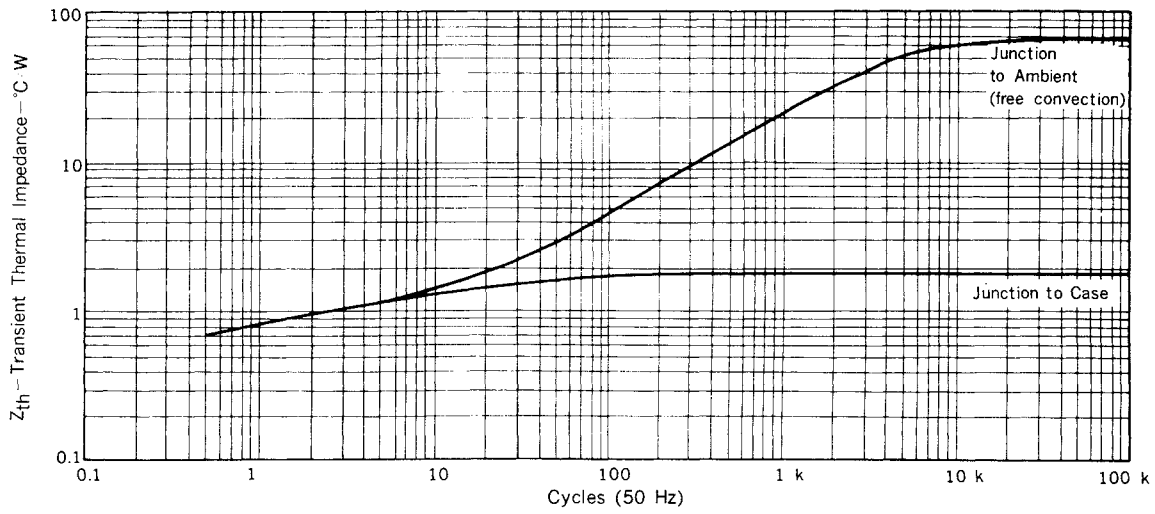

Fig. 13 Z_{th} CHARACTERISTIC



NEC Corporation

INTERNATIONAL ELECTRON DEVICES DIV.
SUMITOMO MITA Building, 37-8,
Shiba Gochome, Minato-ku, Tokyo 108, Japan
Tel: Tokyo 456-3111
Telex Address: NECTOK J22686
Cable Address: NEC TOKYO



LittleDiode supplies new, hard to find or obsolete electronic components and semiconductors all over the world.

With over two million different components listed you are sure to find the part you need.

Feel free to visit us today at our online store:

LittleDiode.com

Looking forward to providing you with the best possible service.