

DATA SHEET

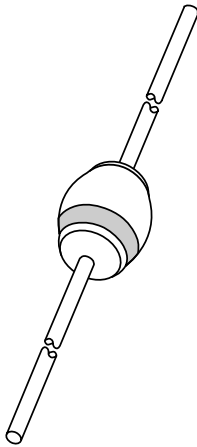

BYX10G Rectifier

Product specification

1996 May 24

Rectifier

BYX10G

FEATURES

- Glass passivated
- High maximum operating temperature
- Low leakage current
- Excellent stability
- Available in ammo-pack.

DESCRIPTION

Rugged glass package, using a high temperature alloyed construction.

This package is hermetically sealed and fatigue free as coefficients of expansion of all used parts are matched.

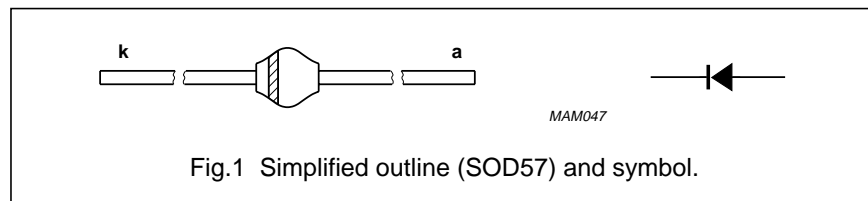

LIMITING VALUES

In accordance with the Absolute Maximum Rating System (IEC 134).

SYMBOL	PARAMETER	CONDITIONS	MIN.	MAX.	UNIT
V_{RSM}	non-repetitive peak reverse voltage		–	1600	V
V_{RRM}	repetitive peak reverse voltage		–	1600	V
V_{RWM}	crest working reverse voltage		–	800	V
$I_{F(AV)}$	average forward current	$T_{tp} = 50\text{ °C}$; lead length = 10 mm; averaged over any 20 ms period; see Figs 2 and 4	–	1.2	A
		$T_{amb} = 60\text{ °C}$; PCB mounting (see Fig.9); averaged over any 20 ms period; see Figs 3 and 4	–	0.6	A
I_{FSM}	non-repetitive peak forward current	$t = 10\text{ ms}$ half sinewave; $T_j = T_{j\text{ max}}$ prior to surge; $V_R = V_{RWM\text{ max}}$	–	25	A
T_{stg}	storage temperature		–65	+175	°C
T_j	junction temperature	see Fig.5	–65	+175	°C

Rectifier

BYX10G

ELECTRICAL CHARACTERISTICS

$T_j = 25\text{ °C}$; unless otherwise specified.

SYMBOL	PARAMETER	CONDITIONS	MIN.	TYP.	MAX.	UNIT
V_F	forward voltage	$I_F = 2\text{ A}$; $T_j = T_{j\text{ max}}$; see Fig.6	–	–	1.5	V
		$I_F = 2\text{ A}$; see Fig.6	–	–	1.5	V
I_R	reverse current	$V_R = V_{RWM\text{ max}}$; see Fig.7	–	–	1	μA
		$V_R = V_{RWM\text{ max}}$; $T_j = 150\text{ °C}$; see Fig.7	–	–	200	μA
t_{rr}	reverse recovery time	when switched from $I_F = 0.5\text{ A}$ to $I_R = 1\text{ A}$; measured at $I_R = 0.25\text{ A}$; see Fig.10	–	3	–	μs
C_d	diode capacitance	$V_R = 0\text{ V}$; $f = 1\text{ MHz}$; see Fig.8	–	30	–	pF

THERMAL CHARACTERISTICS

SYMBOL	PARAMETER	CONDITIONS	VALUE	UNIT
$R_{th\ j-tp}$	thermal resistance from junction to tie-point	lead length = 10 mm	46	K/W
$R_{th\ j-a}$	thermal resistance from junction to ambient	note 1	100	K/W

Note

1. Device mounted on epoxy-glass printed-circuit board, 1.5 mm thick; thickness of copper $\geq 40\ \mu\text{m}$, see Fig.9. For more information please refer to the "General Part of associated Handbook".

Rectifier

BYX10G

GRAPHICAL DATA

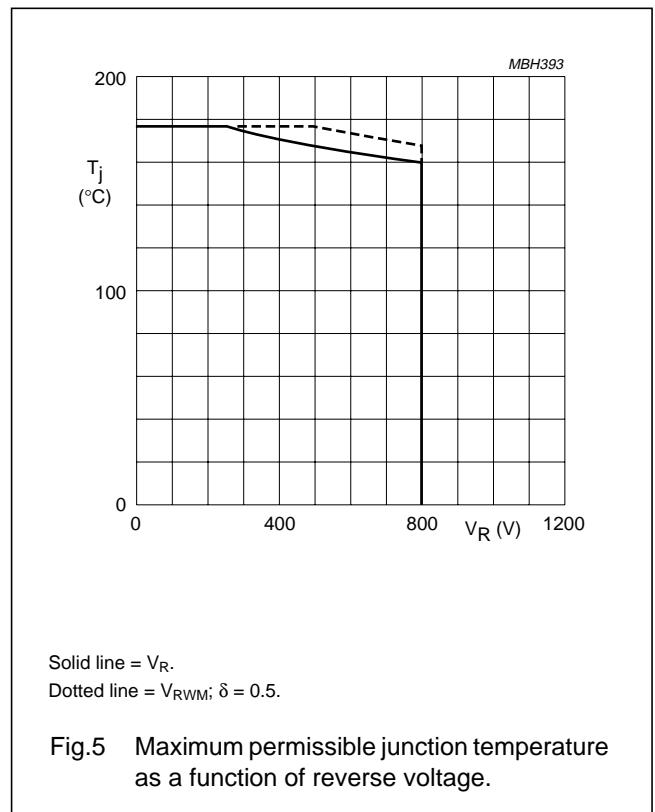
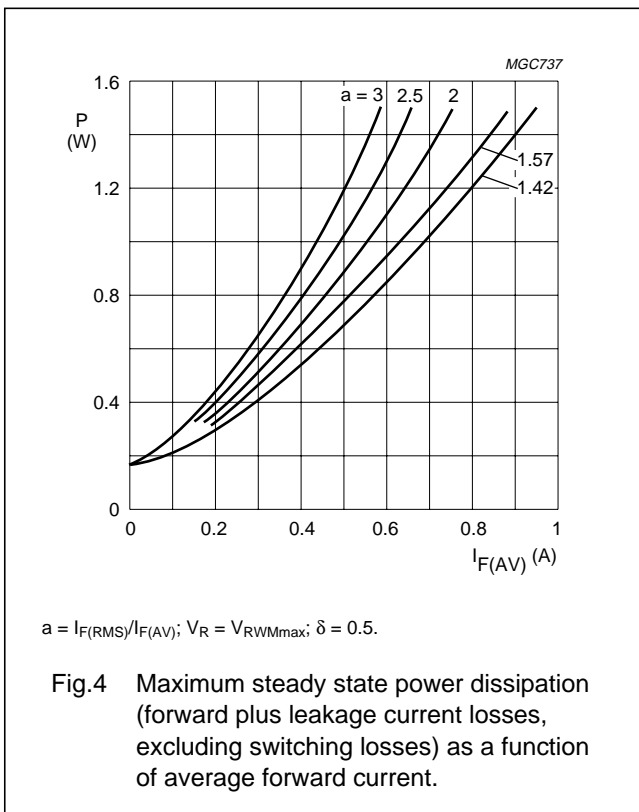
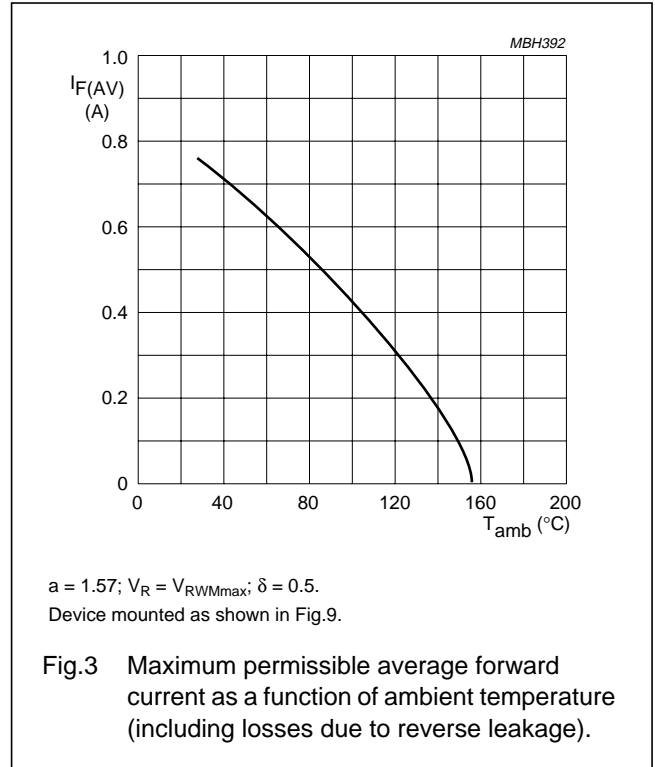
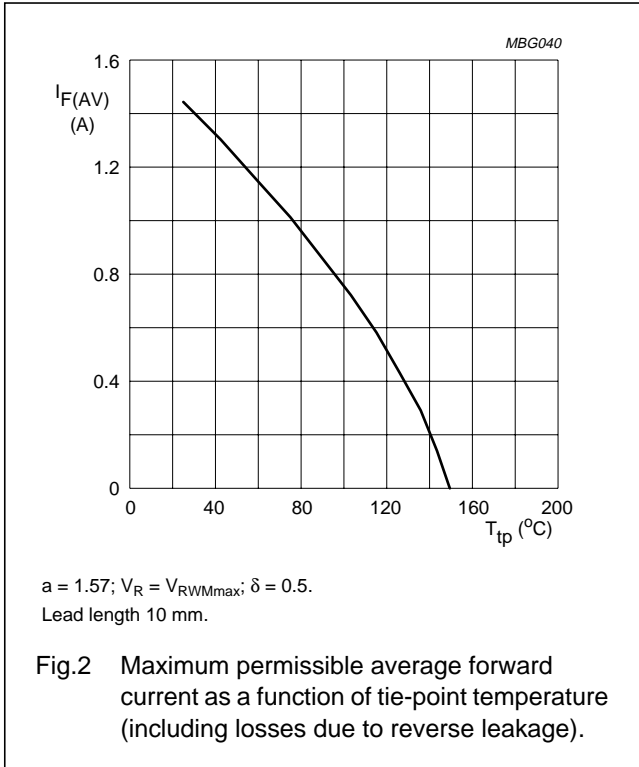

Rectifier

BYX10G

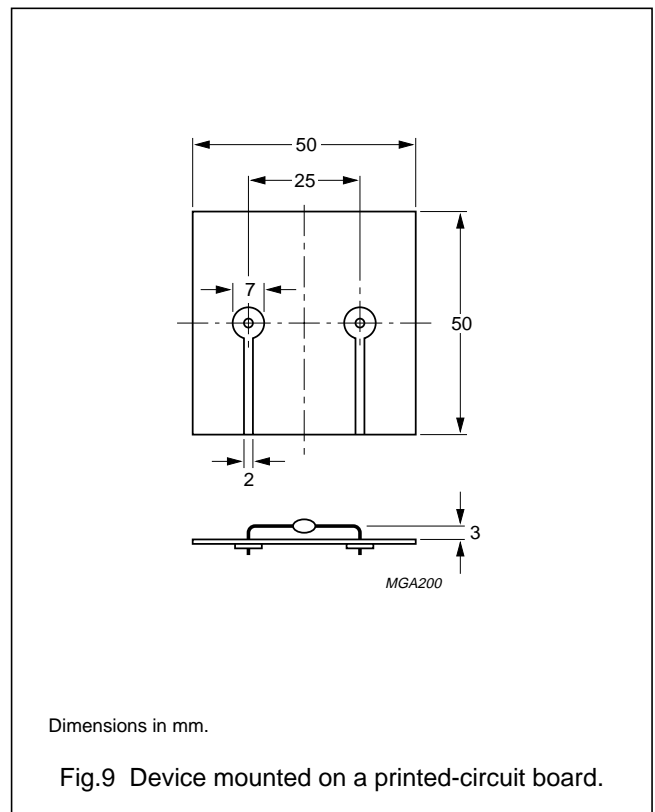
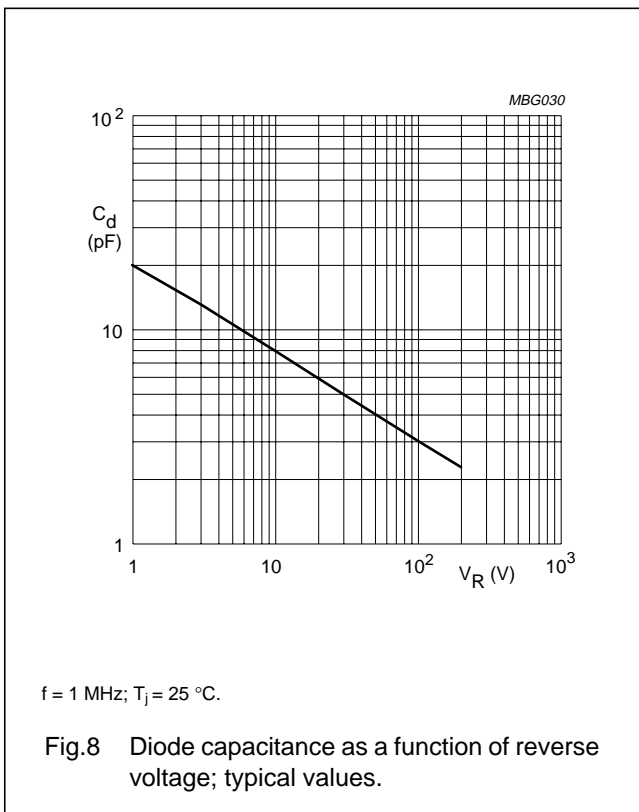
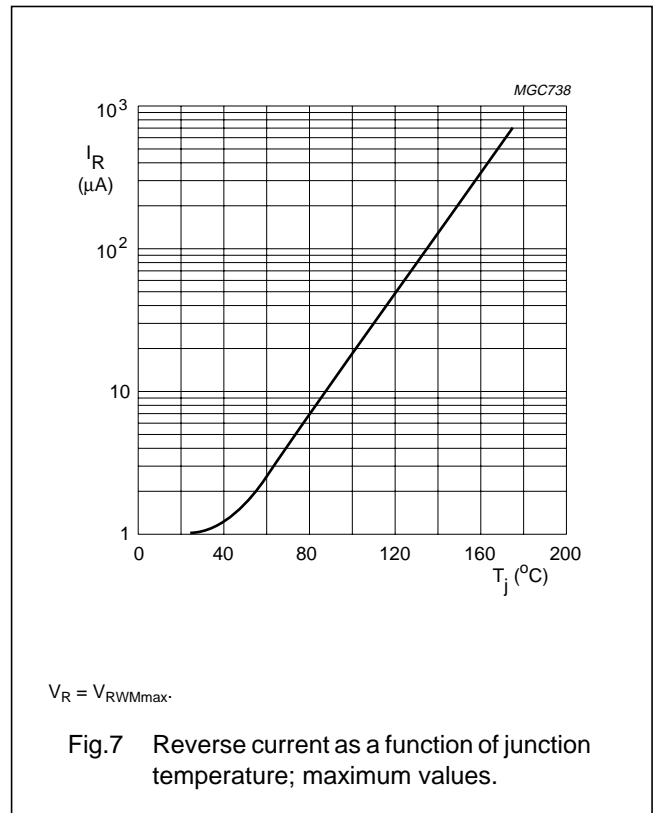
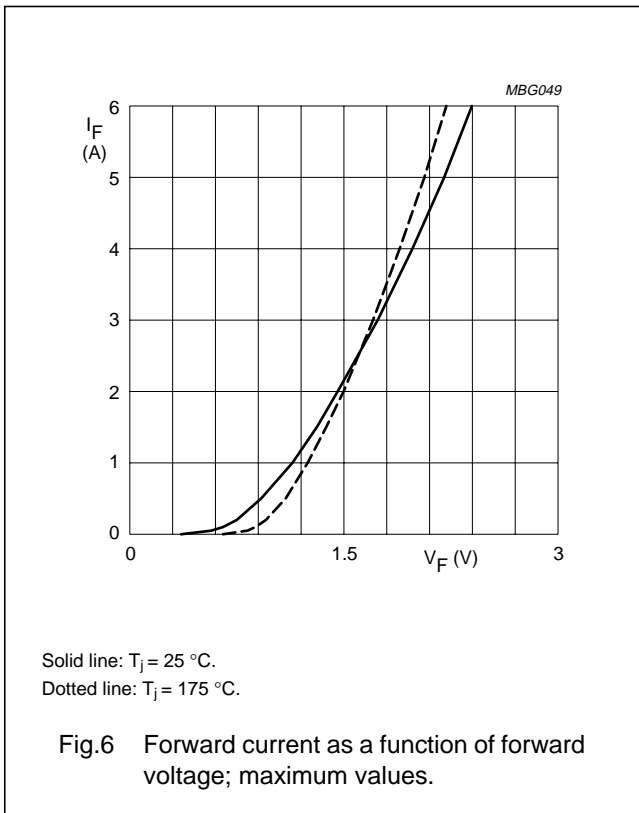

Rectifier

BYX10G

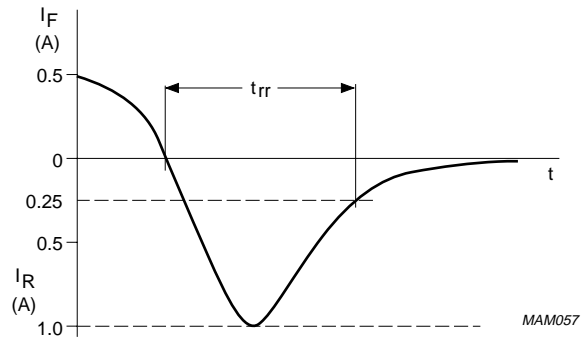
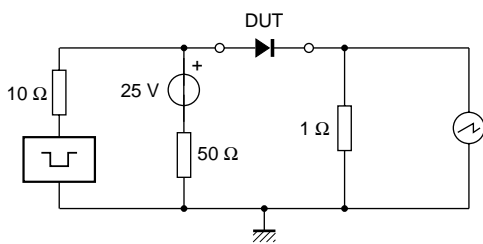

Input impedance oscilloscope: 1 MΩ, 22 pF; $t_r \leq 7$ ns.
Source impedance: 50 Ω; $t_r \leq 15$ ns.

Fig.10 Test circuit and reverse recovery time waveform and definition.

Rectifier

BYX10G

PACKAGE OUTLINE

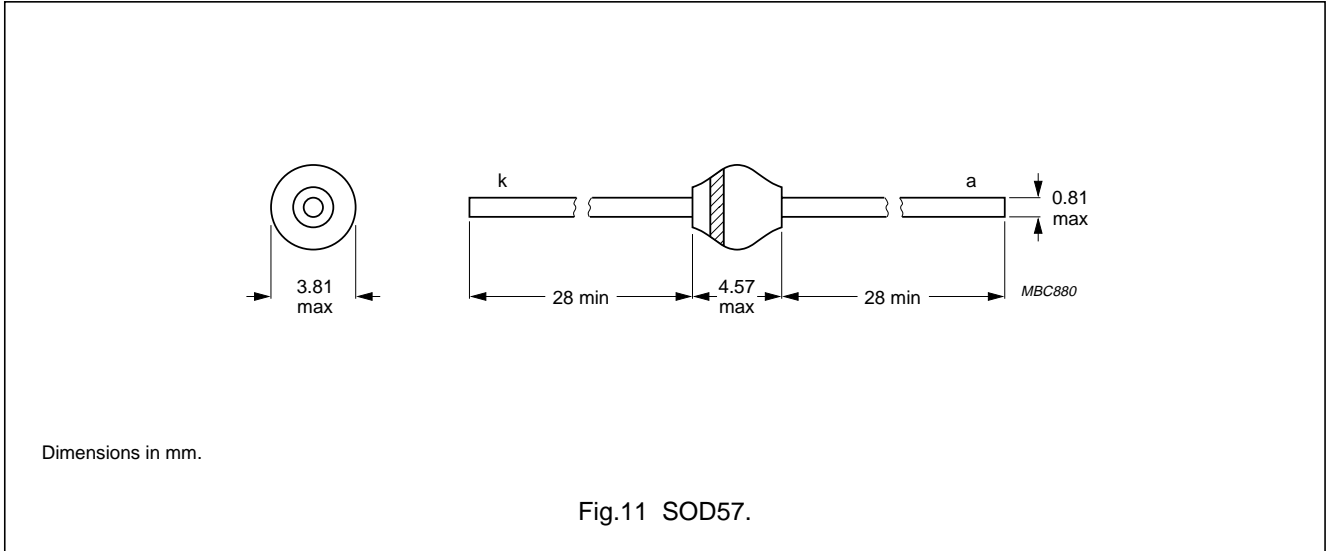

DEFINITIONS

Data sheet status	
Objective specification	This data sheet contains target or goal specifications for product development.
Preliminary specification	This data sheet contains preliminary data; supplementary data may be published later.
Product specification	This data sheet contains final product specifications.
Limiting values	
Limiting values given are in accordance with the Absolute Maximum Rating System (IEC 134). Stress above one or more of the limiting values may cause permanent damage to the device. These are stress ratings only and operation of the device at these or at any other conditions above those given in the Characteristics sections of the specification is not implied. Exposure to limiting values for extended periods may affect device reliability.	
Application information	
Where application information is given, it is advisory and does not form part of the specification.	

LIFE SUPPORT APPLICATIONS

These products are not designed for use in life support appliances, devices, or systems where malfunction of these products can reasonably be expected to result in personal injury. Philips customers using or selling these products for use in such applications do so at their own risk and agree to fully indemnify Philips for any damages resulting from such improper use or sale.



LittleDiode supplies new, hard to find or obsolete electronic components and semiconductors all over the world.

With over two million different components listed you are sure to find the part you need.

Feel free to visit us today at our online store:

LittleDiode.com

Looking forward to providing you with the best possible service.