

Ultra-Fast-Recovery Rectifier Diodes

Parameter Type No.	Absolute Maximum Ratings					Electrical Characteristics (Ta = 25°C)							Others					
	VRM (V)	IF(AV) (A)	IFSM (A) 50Hz Half-cycle Sinewave Single Shot	TJ (°C)	Tstg (°C)	VF (V)	IR (μA)	IR (H) (mA)	trr ① (ns)	trr ② (ns)	Rth (j-ℓ) (°C/W)	Mass (g)	Fig.					
						max	IF (A)	VR = VRM max	VR = VRM TJ = 150°C max	IF/IRP (mA)	IF/IRP (mA)							
EN01Z	200	1.0	50	-40 to +150	0.92	1	10	2	100	100/100	50	100/200	20	0.2	Ⓐ			
RN 1Z	200	1.5	60			1.5	20	3								15	0.4	Ⓑ
RN 2Z	200	2.0	70			2	50	4								12		

EN01Z

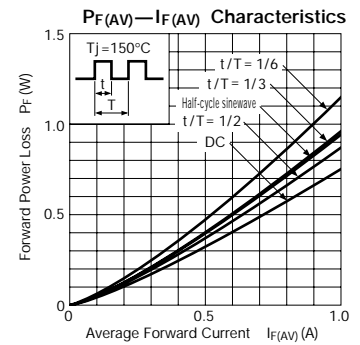
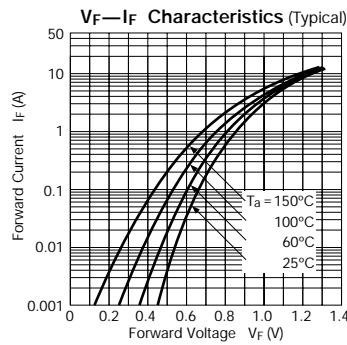
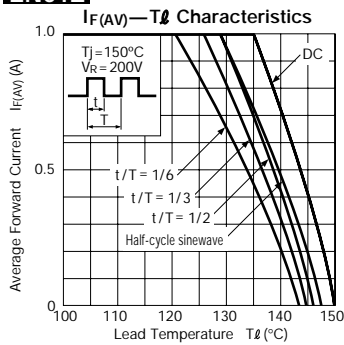

RN 1Z

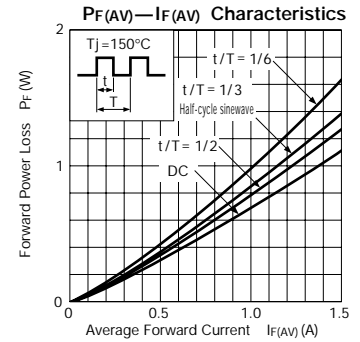
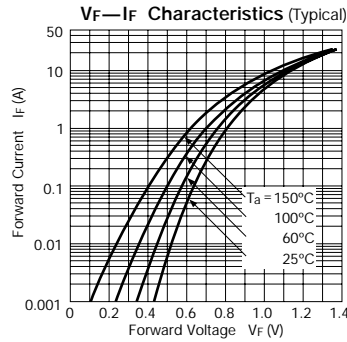
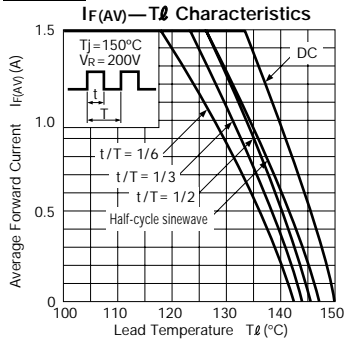

RN 2Z

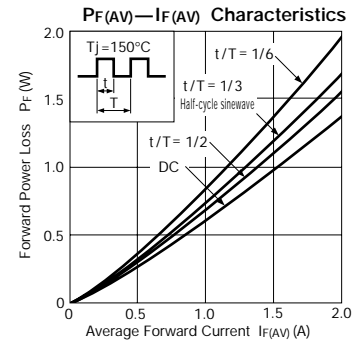
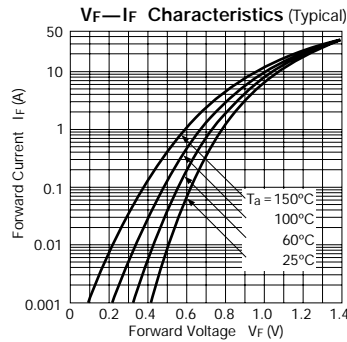
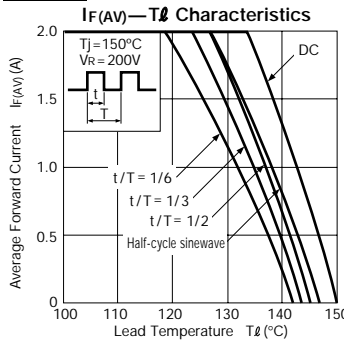

External Dimensions (Unit: mm)

Flammability:
UL94V-0 or Equivalent

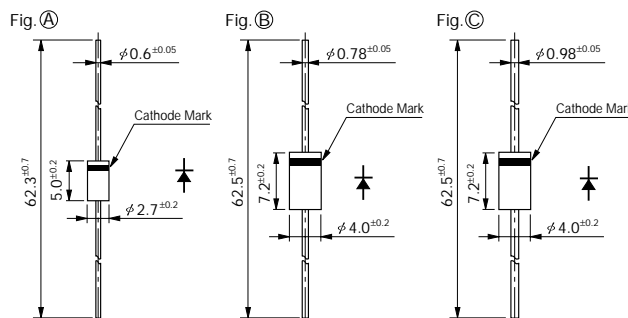

This datasheet has been downloaded from:

www.DatasheetCatalog.com

Datasheets for electronic components.



LittleDiode supplies new, hard to find or obsolete electronic components and semiconductors all over the world.

With over two million different components listed you are sure to find the part you need.

Feel free to visit us today at our online store:

LittleDiode.com

Looking forward to providing you with the best possible service.