



SANYO Semiconductors

DATA SHEET

An ON Semiconductor Company

2SC6097 — NPN Epitaxial Planar Silicon Transistor High-Current Switching Applications

Applications

- DC / DC converter, relay drivers, lamp drivers, motor drivers, inverter

Features

- Adoption of FBET, MBIT process
- Low collector-to-emitter saturation voltage
- High allowable power dissipation
- Large current capacity
- High-speed switching

Specifications

Absolute Maximum Ratings at Ta=25°C

Parameter	Symbol	Conditions	Ratings	Unit
Collector-to-Base Voltage	VCBO		100	V
Collector-to-Emitter Voltage	VCES		100	V
Collector-to-Emitter Voltage	VCEO		60	V
Emitter-to-Base Voltage	VEBO		6.5	V
Collector Current	IC		3	A
Collector Current (Pulse)	ICP		5	A
Base Current	IB		600	mA

Continued on next page.

Package Dimensions unit : mm (typ)
7518-003

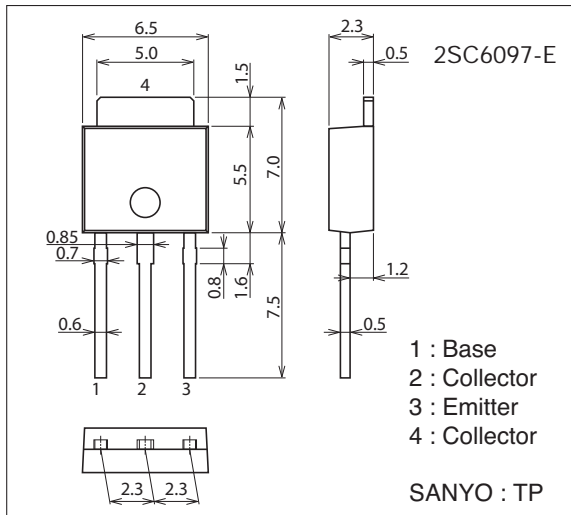

Package Dimensions unit : mm (typ)
7003-003

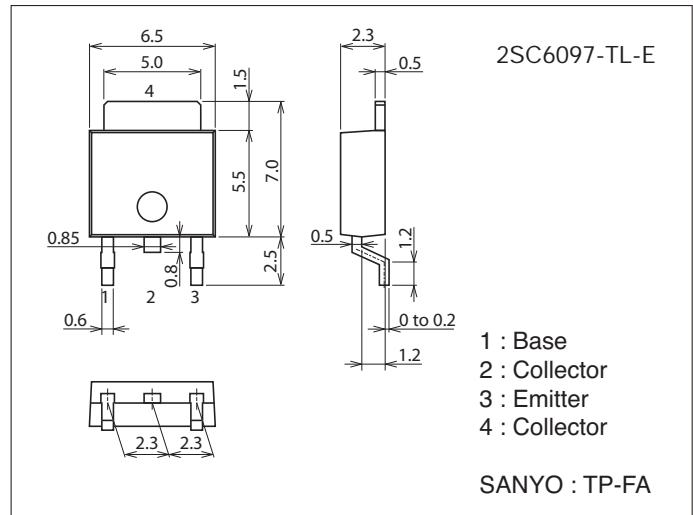

Product & Package Information

- Package : TP
- JEITA, JEDEC : SC-64, TO-251
- Minimum Packing Quantity : 500 pcs./bag

- Package : TP-FA
- JEITA, JEDEC : SC-63, TO-252
- Minimum Packing Quantity : 700 pcs./reel

Marking (TP, TP-FA)

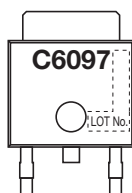

Packing Type (TP-FA) : TL

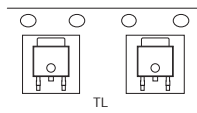

Electrical Connection

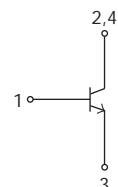

2SC6097

Continued from preceding page.

Parameter	Symbol	Conditions	Ratings	Unit
Collector Dissipation	PC		0.8	W
		T _c =25°C	15	W
Junction Temperature	T _j		150	°C
Storage Temperature	T _{stg}		-55 to +150	°C

Electrical Characteristics at T_a=25°C

Parameter	Symbol	Conditions	Ratings			Unit
			min	typ	max	
Collector Cutoff Current	I _{CBO}	V _{CB} =50V, I _E =0A			1	μA
Emitter Cutoff Current	I _{EBO}	V _{EB} =4V, I _C =0A			1	μA
DC Current Gain	h _{FE}	V _{CE} =2V, I _C =100mA	300		600	
Gain-Bandwidth Product	f _T	V _{CE} =10V, I _C =500mA		390		MHz
Output Capacitance	C _{ob}	V _{CB} =10V, f=1MHz		18		pF
Collector-to-Emitter Saturation Voltage	V _{CE(sat)1}	I _C =1A, I _B =50mA		100	150	mV
	V _{CE(sat)2}	I _C =1A, I _B =100mA		90	135	mV
Base-to-Emitter Saturation Voltage	V _{BE(sat)}	I _C =1A, I _B =100mA		0.84	1.2	V
Collector-to-Base Breakdown Voltage	V(BR)CBO	I _C =10μA, I _E =0A	100			V
Collector-to-Emitter Breakdown Voltage	V(BR)CES	I _C =100μA, R _{BE} =0Ω	100			V
Collector-to-Emitter Breakdown Voltage	V(BR)CEO	I _C =1mA, R _{BE} =∞	60			V
Emitter-to-Base Breakdown Voltage	V(BR)EBO	I _E =10μA, I _C =0A	6.5			V
Turn-On Time	t _{on}	See specified Test Circuit		35		ns
Storage Time	t _{stg}			680		ns
Fall Time	t _f			24		ns

Switching Time Test Circuit

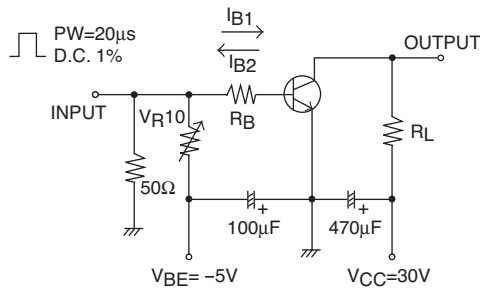

$$I_C = 10I_{B1} = -10I_{B2} = 0.5A$$

Ordering Information

Device	Package	Shipping	memo
2SC6097-E	TP	500pcs./bag	Pb Free
2SC6097-TL-E	TP-FA	700pcs./reel	Pb Free

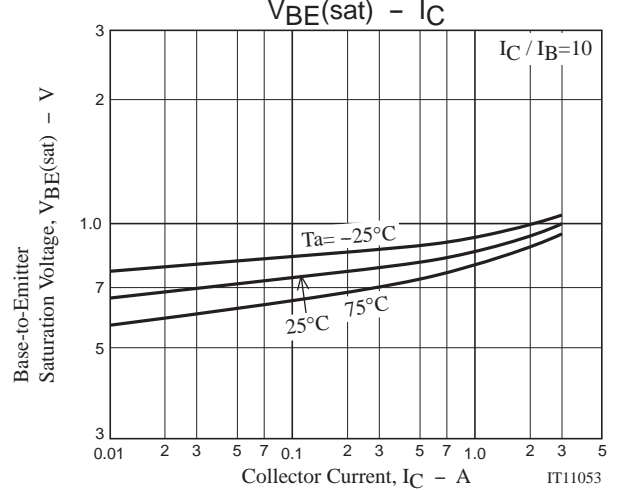
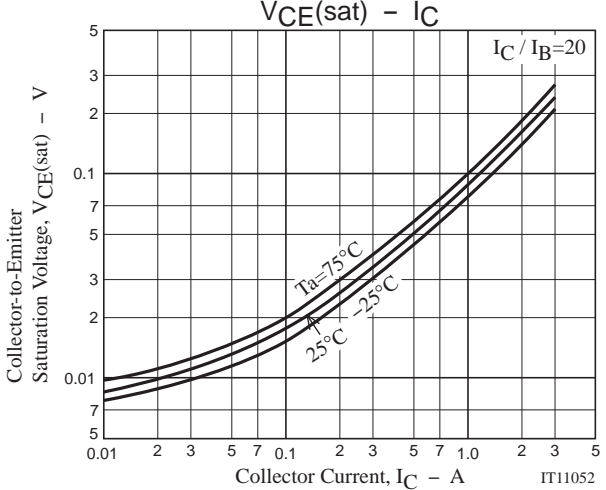
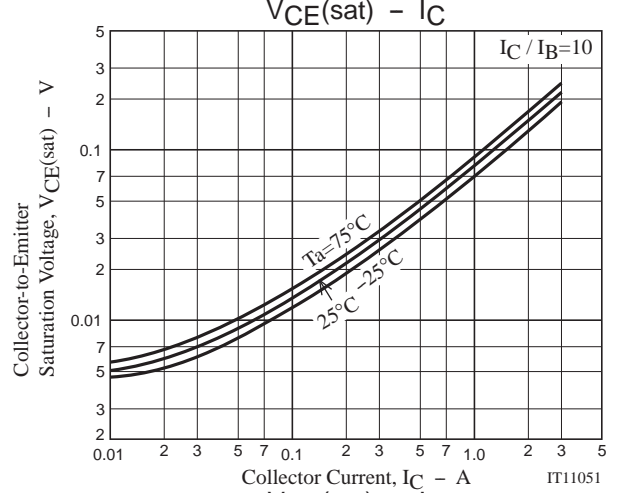
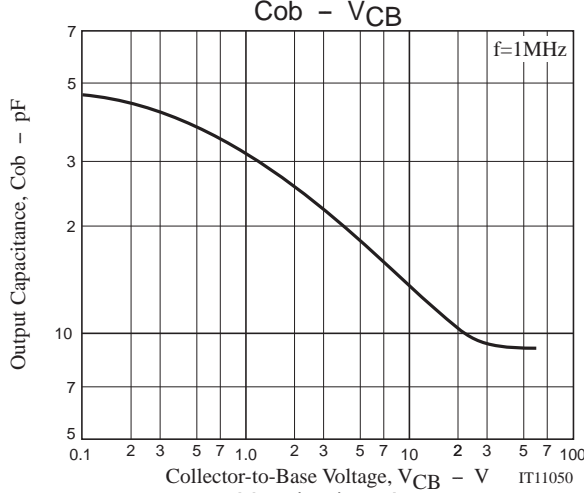
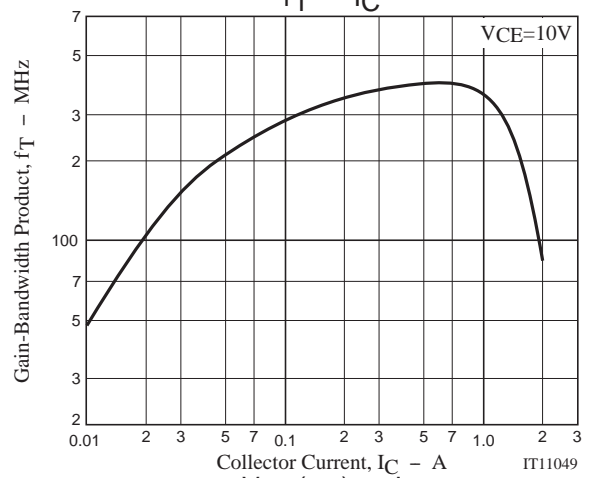
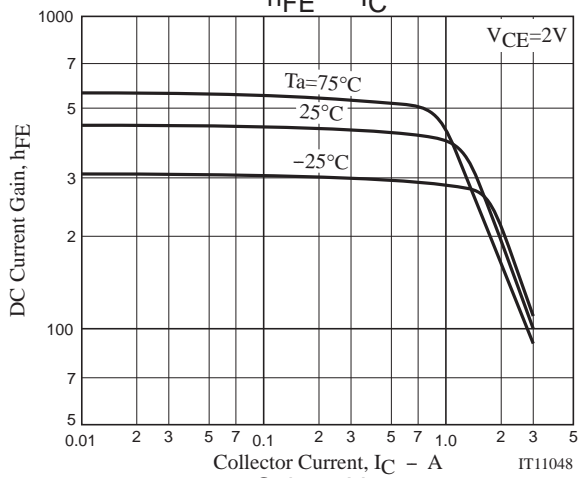
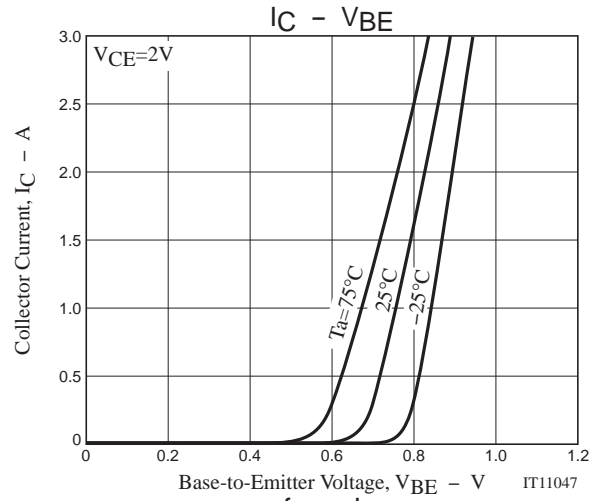
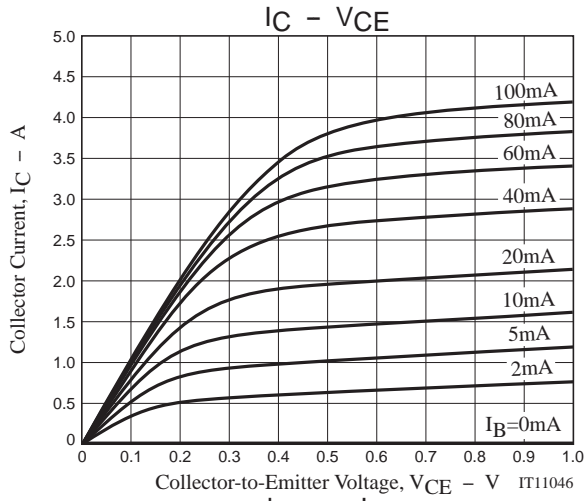

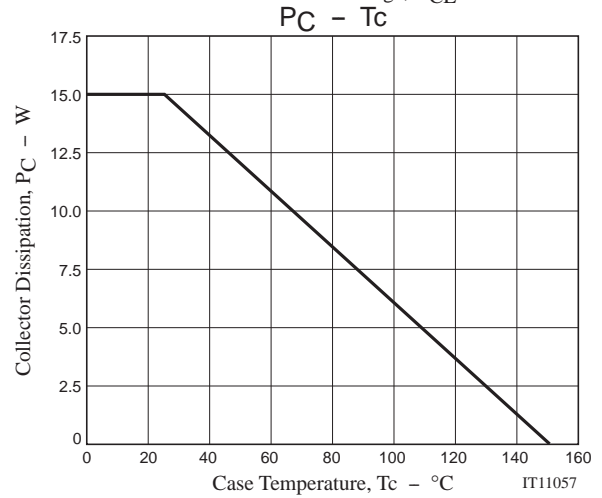
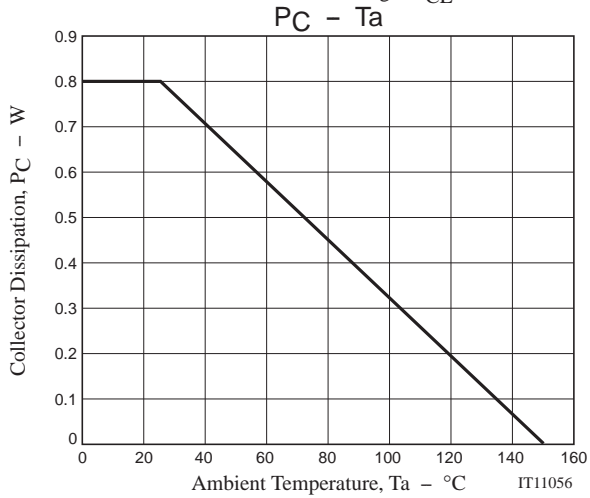
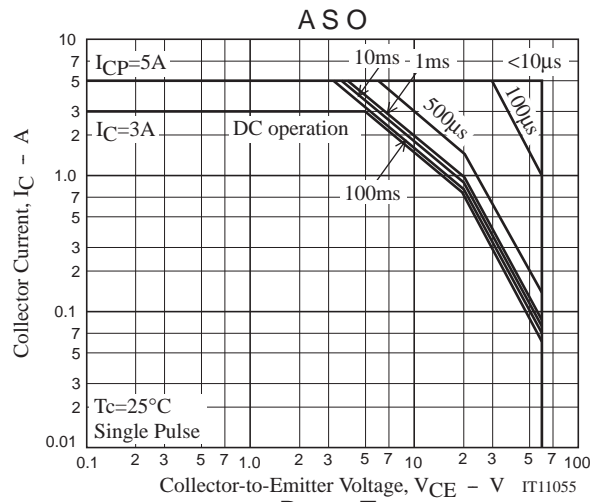
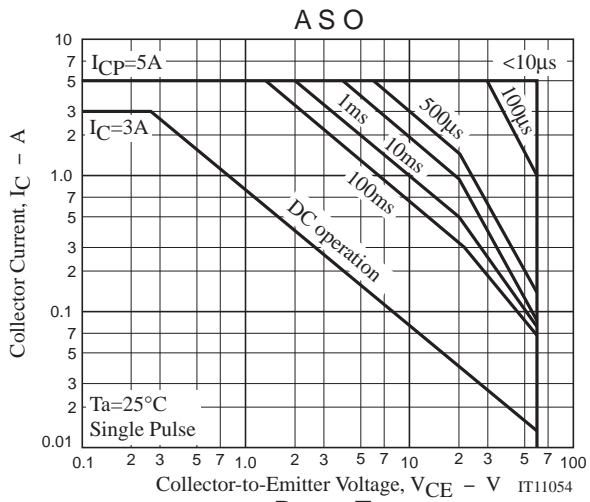

Taping Specification

2SC6097-TL-E

Packing Format

Package Name	Carrier Tape Type	Maximum Number of devices contained (pcs)			Packing format	
		Reel	Inner box	Outer box	Inner BOX (C-1)	Outer BOX (A-7)
TP-FA	TP	700	2,100	12,600	3 reels contained Dimensions:mm (external) 183×72×185	6 inner boxes contained Dimensions:mm (external) 440×195×210

Reel label, Inner box label
(unit:mm)

Outer box label

It is a label at the time of factory shipments.
The form of a label may change in physical distribution process.

Packing method

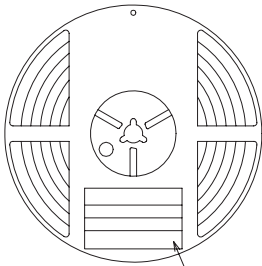

Type No.
LOT No.
Quantity
Origin

Reel label

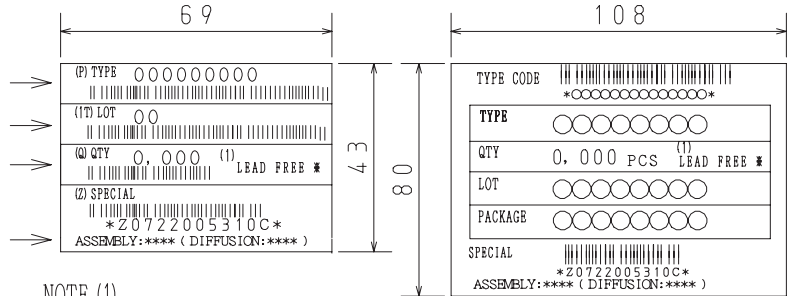

NOTE (1)

The LEAD FREE * description shows that the surface treatment of the terminal is lead free.

Label	JEITA Phase
LEAD FREE 3	JEITA Phase 3A
LEAD FREE 4	JEITA Phase 3

Taping configuration

1. Carrier tape size (unit:mm)

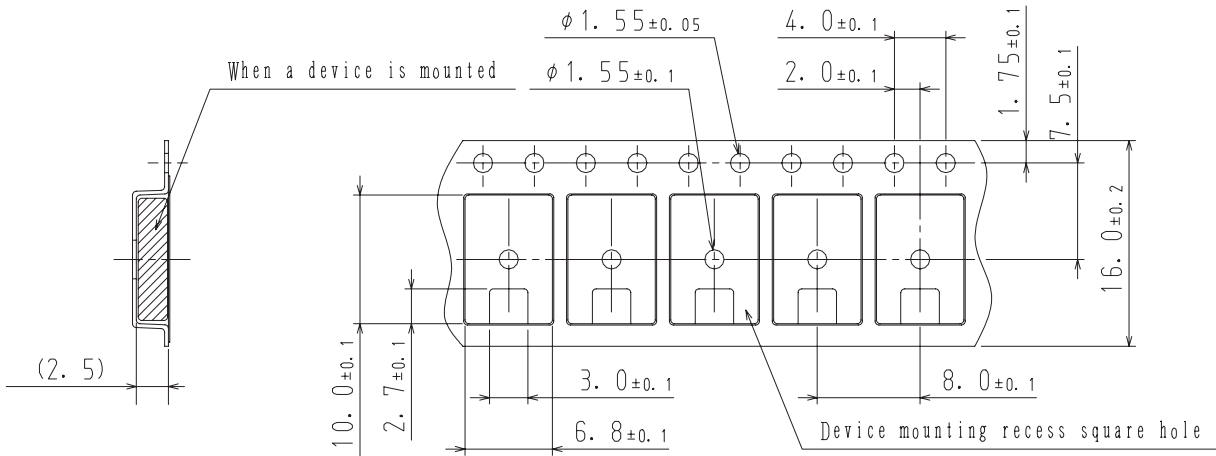

2. Device placement direction

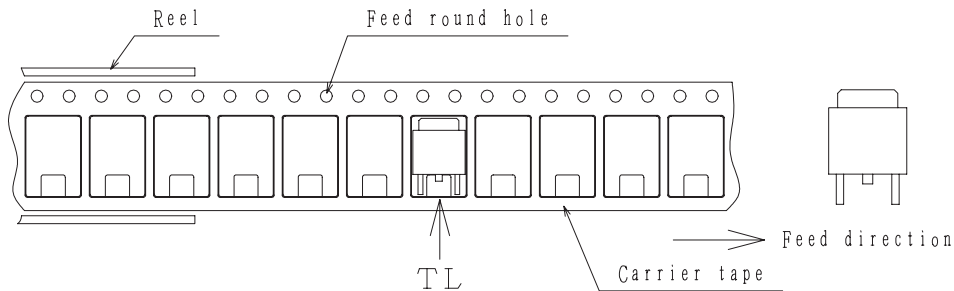

Those with one electrode terminal on the feed hole side.....TL

Outline Drawing

2SC6097-TL-E

Land Pattern Example

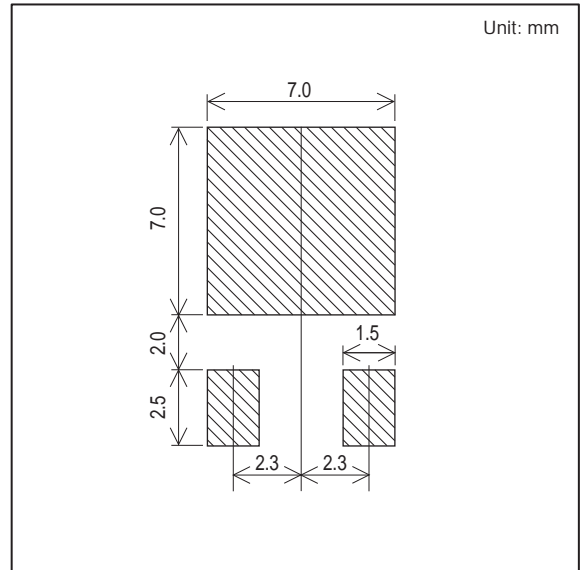
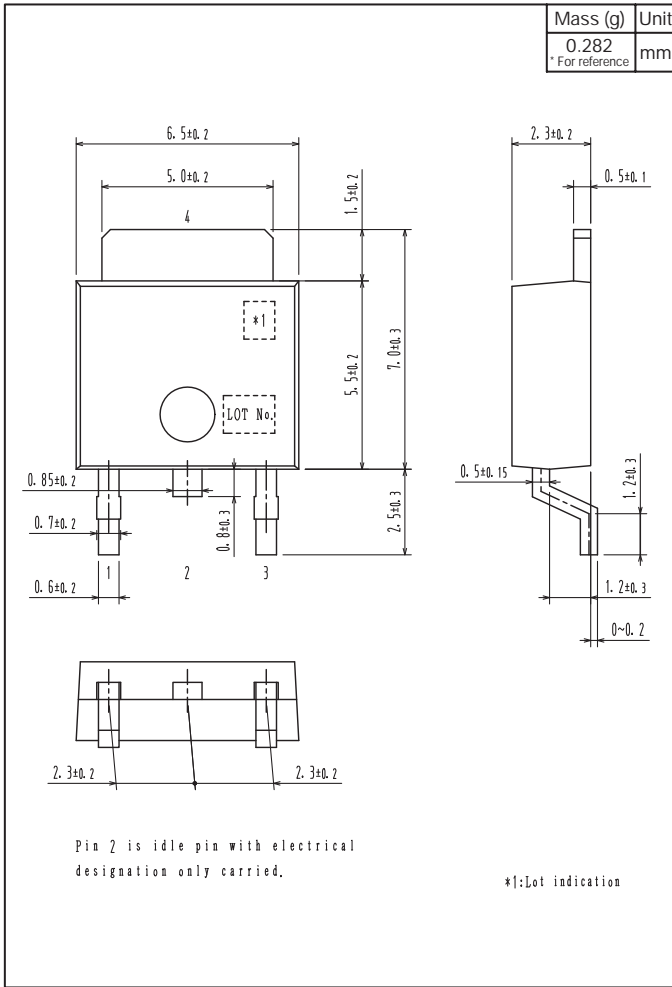

Bag Packing Specification

2SC6097-E

1. Packing Format

Package Name	Maximum Number of devices contained (pcs)			
	Bag	Inner box	Outer box	
TP	500	B-1	A-1	A-2
		10,000	50,000	30,000
	Packing format (Dimensions:mm (external))			
		Inner box	Outer box	
		B-1	A-1	A-2
		445×225×55	470×250×300	470×250×190

2. Bag dimensions
(unit:mm)

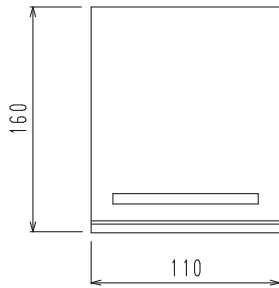

3. Bag label, Inner box label
(unit:mm)

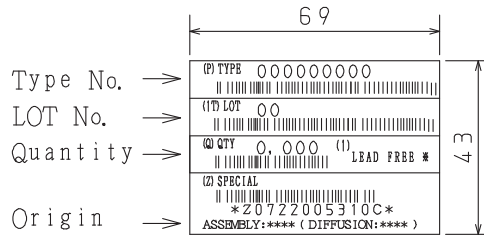

4. Outer box label
(unit:mm)

It is a label at the time of factory shipments,
The form of a label may change in physical
distribution process,

NOTE (1)

The LEAD FREE * description shows that the
surface treatment of the terminal is lead free.

Label	JEITA Phase
LEAD FREE 3	JEITA Phase 3A
LEAD FREE 4	JEITA Phase 3

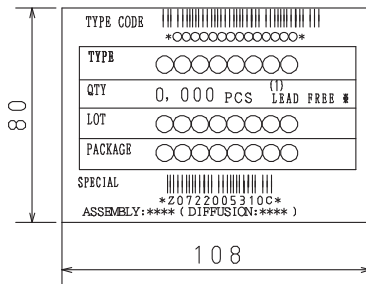

Outline Drawing

2SC6097-E

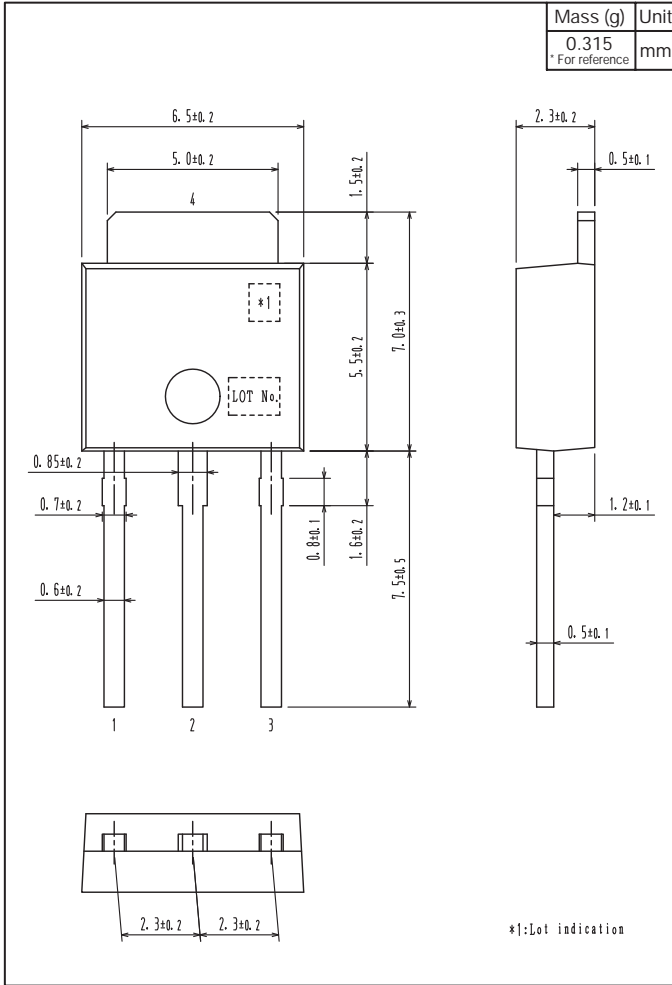

- Any and all SANYO Semiconductor Co.,Ltd. products described or contained herein are, with regard to "standard application", intended for the use as general electronics equipment. The products mentioned herein shall not be intended for use for any "special application" (medical equipment whose purpose is to sustain life, aerospace instrument, nuclear control device, burning appliances, transportation machine, traffic signal system, safety equipment etc.) that shall require extremely high level of reliability and can directly threaten human lives in case of failure or malfunction of the product or may cause harm to human bodies, nor shall they grant any guarantee thereof. If you should intend to use our products for new introduction or other application different from current conditions on the usage of automotive device, communication device, office equipment, industrial equipment etc. , please consult with us about usage condition (temperature, operation time etc.) prior to the intended use. If there is no consultation or inquiry before the intended use, our customer shall be solely responsible for the use.
- Specifications of any and all SANYO Semiconductor Co.,Ltd. products described or contained herein stipulate the performance, characteristics, and functions of the described products in the independent state, and are not guarantees of the performance, characteristics, and functions of the described products as mounted in the customer's products or equipment. To verify symptoms and states that cannot be evaluated in an independent device, the customer should always evaluate and test devices mounted in the customer's products or equipment.
- SANYO Semiconductor Co.,Ltd. assumes no responsibility for equipment failures that result from using products at values that exceed, even momentarily, rated values (such as maximum ratings, operating condition ranges, or other parameters) listed in products specifications of any and all SANYO Semiconductor Co.,Ltd. products described or contained herein.
- Regarding monolithic semiconductors, if you should intend to use this IC continuously under high temperature, high current, high voltage, or drastic temperature change, even if it is used within the range of absolute maximum ratings or operating conditions, there is a possibility of decrease reliability. Please contact us for a confirmation.
- SANYO Semiconductor Co.,Ltd. strives to supply high-quality high-reliability products, however, any and all semiconductor products fail or malfunction with some probability. It is possible that these probabilistic failures or malfunction could give rise to accidents or events that could endanger human lives, trouble that could give rise to smoke or fire, or accidents that could cause damage to other property. When designing equipment, adopt safety measures so that these kinds of accidents or events cannot occur. Such measures include but are not limited to protective circuits and error prevention circuits for safe design, redundant design, and structural design.
- In the event that any or all SANYO Semiconductor Co.,Ltd. products described or contained herein are controlled under any of applicable local export control laws and regulations, such products may require the export license from the authorities concerned in accordance with the above law.
- No part of this publication may be reproduced or transmitted in any form or by any means, electronic or mechanical, including photocopying and recording, or any information storage or retrieval system, or otherwise, without the prior written consent of SANYO Semiconductor Co.,Ltd.
- Any and all information described or contained herein are subject to change without notice due to product/technology improvement, etc. When designing equipment, refer to the "Delivery Specification" for the SANYO Semiconductor Co.,Ltd. product that you intend to use.
- Upon using the technical information or products described herein, neither warranty nor license shall be granted with regard to intellectual property rights or any other rights of SANYO Semiconductor Co.,Ltd. or any third party. SANYO Semiconductor Co.,Ltd. shall not be liable for any claim or suits with regard to a third party's intellectual property rights which has resulted from the use of the technical information and products mentioned above.

This catalog provides information as of August, 2012. Specifications and information herein are subject to change without notice.



LittleDiode supplies new, hard to find or obsolete electronic components and semiconductors all over the world.

With over two million different components listed you are sure to find the part you need.

Feel free to visit us today at our online store:

LittleDiode.com

Looking forward to providing you with the best possible service.