

## Silicon NPN Planar RF Transistor

Electrostatic sensitive device.  
Observe precautions for handling.



### Applications

RF amplifier up to GHz range, especially for wide band antenna amplifiers.

### Features

- High power gain
- Low noise figure
- High transition frequency

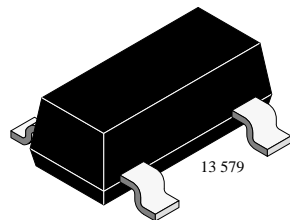
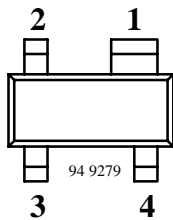

BFP92A Marking: 92V  
Plastic case (SOT 143)  
1 = Collector, 2 = Emitter, 3 = Base, 4 = Emitter

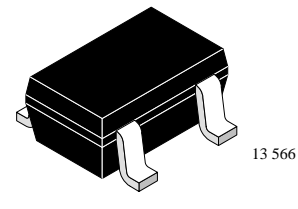
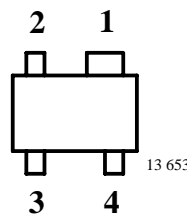

BFP92AW Marking: W92  
Plastic case (SOT 343)  
1 = Collector, 2 = Emitter, 3 = Base, 4 = Emitter

### Absolute Maximum Ratings

$T_{amb} = 25^{\circ}\text{C}$ , unless otherwise specified

Parameter	Test Conditions	Symbol	Value	Unit
Collector-base voltage		$V_{CBO}$	20	V
Collector-emitter voltage		$V_{CEO}$	15	V
Emitter-base voltage		$V_{EBO}$	2	V
Collector current		$I_C$	30	mA
Total power dissipation	$T_{amb} \leq 60^{\circ}\text{C}$	$P_{tot}$	200	mW
Junction temperature		$T_j$	150	$^{\circ}\text{C}$
Storage temperature range		$T_{stg}$	-65 to +150	$^{\circ}\text{C}$

### Maximum Thermal Resistance

$T_{amb} = 25^{\circ}\text{C}$ , unless otherwise specified

Parameter	Test Conditions	Symbol	Value	Unit
Junction ambient	on glass fibre printed board (25 x 20 x 1.5) mm <sup>3</sup> plated with 35 $\mu\text{m}$ Cu	$R_{thJA}$	450	K/W

### Electrical DC Characteristics

$T_{amb} = 25^{\circ}\text{C}$ , unless otherwise specified

Parameter	Test Conditions	Symbol	Min	Typ	Max	Unit
Collector cut-off current	$V_{CE} = 20\text{ V}, V_{BE} = 0$	$I_{CES}$			100	$\mu\text{A}$
Collector-base cut-off current	$V_{CB} = 15\text{ V}, I_E = 0$	$I_{CBO}$			100	nA
Emitter-base cut-off current	$V_{EB} = 2\text{ V}, I_C = 0$	$I_{EBO}$			10	$\mu\text{A}$
Collector-emitter breakdown voltage	$I_C = 1\text{ mA}, I_B = 0$	$V_{(BR)CEO}$	15			V
Collector-emitter saturation voltage	$I_C = 30\text{ mA}, I_B = 3\text{ mA}$	$V_{CEsat}$		0.1	0.4	V
DC forward current transfer ratio	$V_{CE} = 10\text{ V}, I_C = 14\text{ mA}$	$h_{FE}$	50	100	150	

### Electrical AC Characteristics

$T_{amb} = 25^{\circ}\text{C}$ , unless otherwise specified

Parameter	Test Conditions	Symbol	Min	Typ	Max	Unit
Transition frequency	$V_{CE} = 10\text{ V}, I_C = 14\text{ mA}, f = 500\text{ MHz}$	$f_T$		6		GHz
Collector-base capacitance	$V_{CB} = 10\text{ V}, f = 1\text{ MHz}$	$C_{cb}$		0.25		pF
Collector-emitter capacitance	$V_{CE} = 10\text{ V}, f = 1\text{ MHz}$	$C_{ce}$		0.2		pF
Emitter-base capacitance	$V_{EB} = 0.5\text{ V}, f = 1\text{ MHz}$	$C_{eb}$		0.7		pF
Noise figure	$V_{CE} = 10\text{ V}, Z_S = 50\ \Omega, f = 800\text{ MHz}, I_C = 2\text{ mA}$	F		1.8		dB
Power gain	$V_{CE} = 10\text{ V}, Z_L = Z_{Lopt}, I_C = 14\text{ mA}, f = 800\text{ MHz}$	$G_{pe}$		18		dB
Linear output voltage – two tone intermodulation test	$V_{CE} = 10\text{ V}, I_C = 14\text{ mA}, d_{IM} = 60\text{ dB}, f_1 = 806\text{ MHz}, f_2 = 810\text{ MHz}, Z_S = Z_L = 50\ \Omega$	$V_1 = V_2$		120		mV
Third order intercept point	$V_{CE} = 10\text{ V}, I_C = 14\text{ mA}, f = 800\text{ MHz}$	$IP_3$		24		dBm



**Common Emitter S-Parameters**

$Z_0 = 50 \Omega$ ,  $T_{amb} = 25^\circ C$ , unless otherwise specified

$V_{CE}/V$	$I_C/mA$	f/MHz	S11		S21		S12		S22		
			LIN MAG	ANG	LIN MAG	ANG	LIN MAG	ANG	LIN MAG	ANG	
				deg		deg		deg		deg	
5	2	100	0.905	-16.8	6.54	165.6	0.019	78.3	0.973	-6.9	
		300	0.795	-47.3	5.72	142.2	0.049	60.4	0.896	-17.2	
		500	0.677	-72.7	4.83	124.5	0.068	48.5	0.802	-23.3	
		800	0.552	-103.8	3.76	105.3	0.083	37.3	0.707	-28.7	
		1000	0.499	-121.0	3.24	95.7	0.088	33.1	0.671	-31.4	
		1200	0.478	-136.4	2.84	87.2	0.092	29.9	0.643	-33.9	
		1500	0.463	-156.6	2.43	75.5	0.096	26.7	0.614	-37.9	
		1800	0.464	-173.5	2.10	66.0	0.098	25.1	0.592	-42.2	
		2000	0.478	177.2	1.94	59.6	0.100	24.9	0.583	-45.4	
		2200	0.492	166.5	1.81	53.5	0.100	24.9	0.578	-48.3	
		2500	0.501	153.6	1.64	44.5	0.107	25.2	0.572	-53.5	
		2800	0.532	143.0	1.49	36.3	0.106	24.8	0.569	-59.9	
	3000	0.550	136.4	1.40	31.6	0.108	24.8	0.556	-64.3		
	5	5	100	0.790	-27.1	14.00	159.0	0.017	74.0	0.942	-11.7
			300	0.619	-72.1	10.70	129.4	0.039	54.0	0.765	-24.6
			500	0.499	-103.6	8.01	111.4	0.050	45.9	0.634	-28.1
			800	0.427	-137.5	5.60	94.6	0.059	42.3	0.549	-29.8
			1000	0.405	-152.9	4.65	86.6	0.065	41.8	0.524	-31.0
			1200	0.405	-166.6	3.98	79.5	0.070	41.8	0.508	-32.3
			1500	0.415	178.0	3.29	69.7	0.078	41.8	0.490	-35.8
			1800	0.430	165.6	2.80	61.5	0.086	42.1	0.474	-39.9
			2000	0.447	157.7	2.57	55.9	0.092	41.7	0.469	-43.1
			2200	0.465	149.9	2.38	50.7	0.097	41.8	0.465	-46.1
			2500	0.484	140.2	2.12	42.8	0.109	38.9	0.459	-51.9
			2800	0.518	130.8	1.92	35.3	0.113	38.7	0.455	-58.4
	3000	0.533	126.3	1.80	31.1	0.117	37.7	0.443	-62.8		
	10	10	100	0.647	-41.7	22.60	151.4	0.015	69.2	0.889	-16.7
			300	0.475	-100.6	14.47	118.3	0.030	52.9	0.637	-28.3
			500	0.410	-133.3	9.86	102.2	0.038	50.1	0.519	-27.9
			800	0.390	-161.5	6.55	88.2	0.048	51.4	0.462	-26.9
			1000	0.385	-174.9	5.35	81.3	0.055	52.4	0.451	-27.6
			1200	0.394	175.6	4.53	75.1	0.062	52.8	0.442	-28.9
			1500	0.414	164.5	3.70	66.4	0.074	52.3	0.432	-32.6
1800			0.435	153.5	3.13	58.9	0.084	51.7	0.421	-36.8	
2000			0.447	148.0	2.86	53.7	0.092	50.8	0.418	-40.3	
2200			0.468	141.7	2.64	49.0	0.098	49.5	0.416	-43.3	
2500			0.491	133.6	2.36	41.7	0.111	46.2	0.410	-49.4	
2800			0.522	126.2	2.12	34.6	0.116	45.2	0.404	-56.2	
3000	0.538	122.0	1.98	30.7	0.122	43.8	0.392	-60.7			

V <sub>CE</sub> /V	I <sub>C</sub> /mA	f/MHz	S11		S21		S12		S22	
			LIN MAG	ANG	LIN MAG	ANG	LIN MAG	ANG	LIN MAG	ANG
				deg		deg		deg		deg
5	14	100	0.561	-51.8	26.86	147.2	0.013	67.9	0.856	-19.1
		300	0.431	-115.6	15.65	113.6	0.026	53.2	0.584	-28.5
		500	0.398	-146.2	10.34	98.7	0.034	53.7	0.483	-26.3
		800	0.391	-171.1	6.75	85.8	0.045	55.9	0.441	-24.8
		1000	0.392	177.6	5.50	79.3	0.053	56.9	0.435	-25.3
		1200	0.401	169.2	4.65	73.3	0.061	57.1	0.430	-26.9
		1500	0.423	159.4	3.79	65.1	0.072	56.2	0.421	-30.7
		1800	0.440	150.1	3.20	57.8	0.083	54.7	0.413	-35.3
		2000	0.455	145.6	2.91	52.7	0.091	53.6	0.410	-38.9
		2200	0.478	139.1	2.68	48.2	0.098	52.4	0.408	-42.0
		2500	0.499	131.7	2.40	40.9	0.111	49.2	0.403	-48.3
		2800	0.533	124.3	2.15	33.9	0.116	47.3	0.396	-55.1
	3000	0.546	120.6	2.01	30.0	0.122	46.0	0.383	-59.6	
	20	100	0.478	-65.7	30.79	142.2	0.012	65.1	0.817	-21.1
		300	0.411	-131.9	16.24	109.1	0.023	55.1	0.542	-26.9
		500	0.402	-158.4	10.48	95.5	0.030	57.7	0.462	-23.5
		800	0.404	-178.7	6.75	83.5	0.042	60.5	0.436	-22.0
		1000	0.408	171.6	5.48	77.5	0.050	61.0	0.433	-23.0
		1200	0.423	164.2	4.62	71.6	0.059	60.6	0.431	-24.8
		1500	0.440	155.4	3.77	63.6	0.070	59.2	0.425	-29.1
		1800	0.460	147.0	3.17	56.5	0.082	57.7	0.417	-33.8
		2000	0.476	142.7	2.89	51.7	0.090	56.1	0.415	-37.5
		2200	0.496	137.1	2.66	46.9	0.097	54.8	0.413	-40.8
		2500	0.514	129.7	2.36	39.6	0.109	51.4	0.409	-47.0
		2800	0.548	123.0	2.12	33.0	0.115	49.5	0.402	-54.0
	3000	0.562	119.2	1.99	29.12	0.121	48.0	0.390	-58.5	
	30	100	0.413	-89.8	32.20	135.2	0.010	63.8	0.766	-21.5
		300	0.427	-149.8	15.29	104.0	0.019	57.7	0.530	-21.9
		500	0.433	-170.2	9.65	91.9	0.027	62.2	0.480	-18.6
		800	0.445	173.9	6.17	80.9	0.038	64.9	0.467	-18.7
		1000	0.449	165.9	5.01	75.2	0.047	65.0	0.467	-20.5
		1200	0.459	159.6	4.22	69.5	0.055	64.8	0.467	-22.8
		1500	0.478	152.2	3.42	61.5	0.066	62.9	0.461	-27.5
		1800	0.500	144.4	2.87	54.5	0.078	60.9	0.455	-32.7
		2000	0.516	140.5	2.61	49.5	0.085	59.7	0.453	-36.4
		2200	0.541	134.6	2.41	44.8	0.092	58.0	0.452	-39.8
2500		0.556	127.8	2.15	37.8	0.105	54.6	0.447	-46.1	
2800		0.588	121.4	1.92	30.9	0.110	53.1	0.444	-53.2	
3000	0.601	117.5	1.80	27.0	0.116	51.8	0.431	-57.8		



V <sub>CE</sub> /V	I <sub>C</sub> /mA	f/MHz	S11		S21		S12		S22	
			LIN MAG	ANG	LIN MAG	ANG	LIN MAG	ANG	LIN MAG	ANG
				deg		deg		deg		deg
10	2	100	0.916	-15.8	6.53	166.1	0.015	78.4	0.975	-5.9
		300	0.805	-45.0	5.76	143.2	0.041	61.9	0.912	-14.5
		500	0.686	-69.6	4.87	125.6	0.057	49.8	0.833	-19.8
		800	0.554	-100.1	3.84	106.6	0.069	39.8	0.751	-24.8
		1000	0.496	-117.1	3.31	97.0	0.074	35.6	0.720	-27.2
		1200	0.467	-132.6	2.92	88.4	0.078	32.9	0.699	-29.4
		1500	0.451	-153.3	2.50	76.8	0.082	30.2	0.672	-33.5
		1800	0.446	-171.1	2.16	67.3	0.084	29.2	0.654	-37.5
		2000	0.456	178.9	2.00	61.0	0.086	29.0	0.646	-40.2
		2200	0.473	168.5	1.86	55.1	0.087	29.0	0.642	-43.1
		2500	0.487	154.5	1.68	46.0	0.090	29.4	0.638	-47.7
		2800	0.518	143.4	1.54	37.8	0.093	31.1	0.642	-53.7
	3000	0.533	137.3	1.45	33.4	0.095	31.5	0.630	-57.7	
	5	100	0.808	-25.3	13.94	159.8	0.014	74.5	0.950	-9.6
		300	0.633	-67.8	10.82	130.7	0.033	55.5	0.803	-20.3
		500	0.504	-98.6	8.18	112.5	0.042	48.0	0.690	-23.4
		800	0.411	-131.6	5.74	95.6	0.051	44.6	0.618	-25.1
		1000	0.387	-148.3	4.77	87.4	0.055	44.4	0.596	-26.4
		1200	0.381	-162.1	4.09	80.3	0.061	44.6	0.584	-28.0
		1500	0.389	-178.2	3.38	70.6	0.068	45.3	0.568	-31.5
		1800	0.402	167.6	2.88	62.4	0.075	45.5	0.554	-35.6
		2000	0.416	160.7	2.64	57.1	0.080	46.2	0.552	-38.4
		2200	0.437	152.5	2.44	51.8	0.085	46.8	0.550	-41.6
		2500	0.464	142.8	2.19	43.7	0.097	42.4	0.541	-47.0
		2800	0.489	133.7	1.98	36.4	0.099	43.3	0.542	-53.1
	3000	0.510	128.9	1.86	32.3	0.105	42.9	0.530	-57.2	
	10	100	0.680	-38.0	22.27	152.6	0.012	70.4	0.907	-13.5
		300	0.488	-93.5	14.64	119.7	0.026	54.2	0.695	-22.7
		500	0.402	-126.0	10.05	103.3	0.033	51.5	0.596	-22.4
		800	0.365	-156.0	6.68	89.0	0.042	52.9	0.550	-22.3
1000		0.357	-169.7	5.47	81.9	0.048	54.5	0.539	-23.4	
1200		0.365	179.8	4.62	75.8	0.055	55.1	0.535	-25.0	
1500		0.388	167.7	3.80	67.1	0.065	53.6	0.522	-29.0	
1800		0.402	156.4	3.20	59.6	0.073	53.5	0.513	-33.1	
2000		0.415	150.4	2.92	55.0	0.079	53.6	0.514	-35.5	
2200		0.437	144.1	2.70	50.2	0.086	53.1	0.513	-38.9	
2500		0.465	135.9	2.42	42.7	0.098	49.7	0.509	-44.5	
2800		0.492	128.3	2.18	35.6	0.102	49.0	0.505	-50.8	
3000	0.518	124.3	2.04	31.9	0.108	47.9	0.492	-54.8		

V <sub>CE</sub> /V	I <sub>C</sub> /mA	f/MHz	S11		S21		S12		S22	
			LIN MAG	ANG	LIN MAG	ANG	LIN MAG	ANG	LIN MAG	ANG
				deg		deg		deg		deg
10	14	100	0.605	-47.0	26.73	148.2	0.011	68.5	0.879	-15.4
		300	0.436	-108.4	15.89	144.6	0.023	54.4	0.651	-22.2
		500	0.381	-139.9	10.54	99.4	0.029	54.5	0.566	-20.7
		800	0.364	-166.4	6.88	86.3	0.039	57.0	0.534	-20.4
		1000	0.363	-178.7	5.60	79.8	0.046	58.7	0.529	-21.5
		1200	0.370	172.5	4.73	74.1	0.053	59.3	0.527	-23.4
		1500	0.393	162.0	3.87	65.7	0.064	57.3	0.518	-27.7
		1800	0.412	152.2	3.26	58.3	0.073	56.6	0.509	-31.7
		2000	0.424	146.4	2.95	53.8	0.078	56.6	0.509	-34.2
		2200	0.448	140.6	2.73	48.9	0.085	55.8	0.509	-37.9
		2500	0.474	133.9	2.45	41.8	0.097	52.2	0.505	-43.6
		2800	0.502	126.1	2.21	34.8	0.102	51.5	0.502	-49.9
	3000	0.522	122.1	2.07	31.1	0.108	49.9	0.490	-53.9	
	20	100	0.535	-58.5	30.52	143.2	0.011	67.4	0.848	-16.6
		300	0.406	-123.4	16.42	109.9	0.020	55.7	0.620	-20.5
		500	0.379	-152.2	10.60	96.0	0.026	58.1	0.556	-18.3
		800	0.376	-175.1	6.84	83.9	0.037	61.2	0.535	-18.4
		1000	0.377	175.0	5.56	77.9	0.044	62.2	0.535	-20.0
		1200	0.387	167.5	4.68	72.4	0.052	62.5	0.536	-21.9
		1500	0.409	158.0	3.81	64.1	0.061	60.4	0.527	-26.4
		1800	0.430	148.5	3.21	57.1	0.070	59.5	0.519	-30.6
		2000	0.443	144.2	2.91	52.4	0.077	59.0	0.520	-33.6
		2200	0.470	138.9	2.69	47.8	0.084	58.1	0.520	-37.0
		2500	0.489	131.7	2.40	40.5	0.096	54.4	0.516	-42.7
		2800	0.525	124.7	2.16	33.6	0.101	53.7	0.513	-49.1
	3000	0.540	121.6	2.02	30.1	0.107	52.3	0.501	-53.2	
	30	100	0.463	-77.4	32.39	136.5	0.009	62.5	0.810	-16.7
		300	0.410	-141.2	15.52	104.8	0.017	57.7	0.618	-16.7
		500	0.403	-164.4	9.79	92.5	0.023	61.9	0.577	-15.0
		800	0.409	177.5	6.28	81.4	0.034	65.1	0.568	-16.4
		1000	0.415	168.5	5.08	75.6	0.041	66.2	0.568	-18.4
		1200	0.426	162.7	4.27	70.2	0.049	65.9	0.569	-20.9
		1500	0.448	154.5	3.47	62.2	0.058	63.9	0.562	-25.4
		1800	0.472	146.2	2.92	55.2	0.067	63.2	0.554	-29.9
		2000	0.484	141.7	2.66	50.7	0.073	62.5	0.554	-33.1
		2200	0.504	136.3	2.45	46.0	0.080	61.7	0.556	-36.5
2500		0.533	129.5	2.18	38.7	0.091	57.6	0.554	-42.2	
2800		0.565	123.1	1.97	32.0	0.096	57.5	0.553	-48.7	
3000	0.581	119.5	1.84	28.1	0.103	56.4	0.540	-52.8		



### Typical Characteristics ( $T_{amb} = 25^{\circ}\text{C}$ unless otherwise specified)

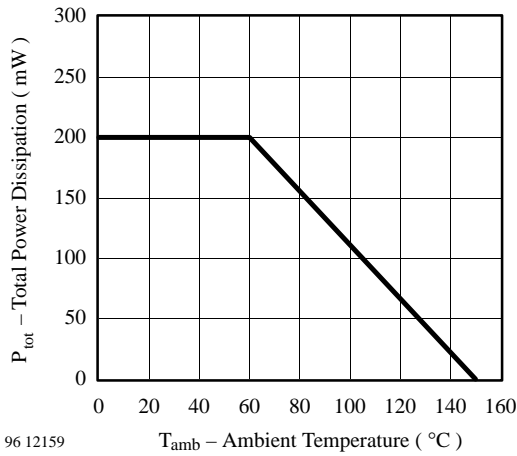

Figure 1. Total Power Dissipation vs. Ambient Temperature

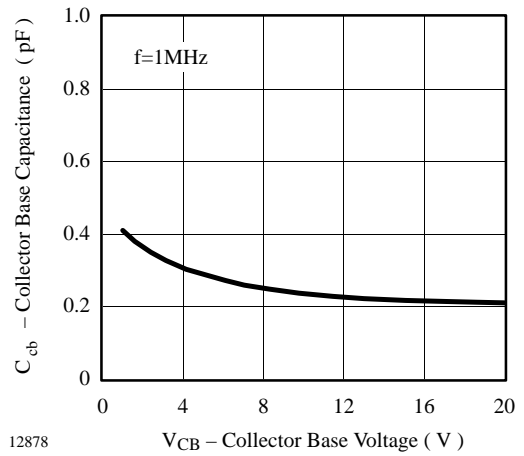

Figure 3. Collector Base Capacitance vs. Collector Base Voltage

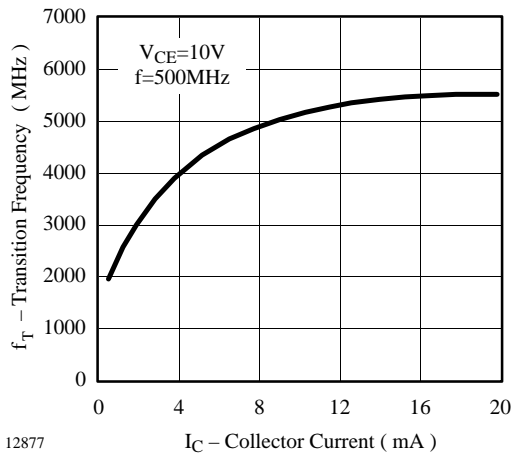

Figure 2. Transition Frequency vs. Collector Current

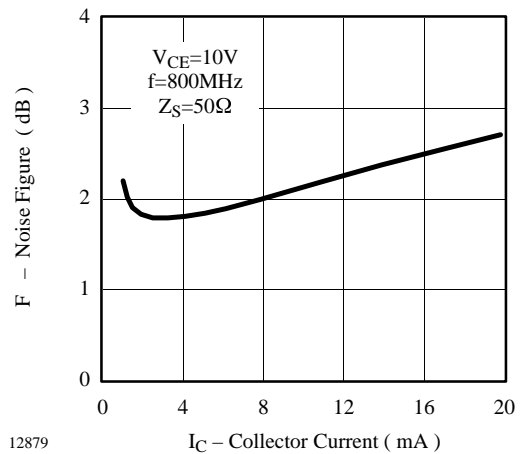

Figure 4. Noise Figure vs. Collector Current

$V_{CE} = 10 \text{ V}$ ,  $I_C = 14 \text{ mA}$ ,  $Z_0 = 50 \Omega$

$S_{11}$

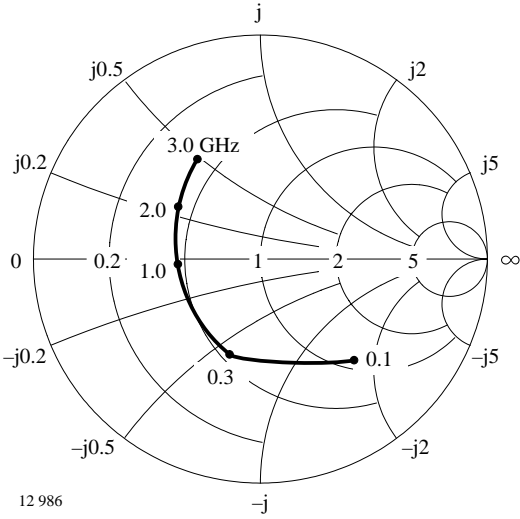

Figure 5. Input reflection coefficient

$S_{12}$

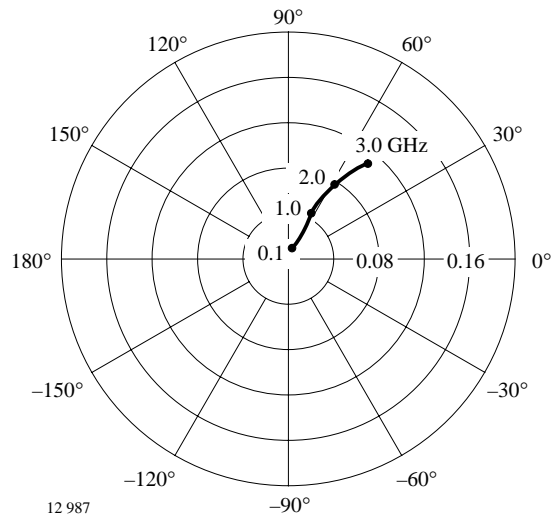

Figure 7. Reverse transmission coefficient

$S_{21}$

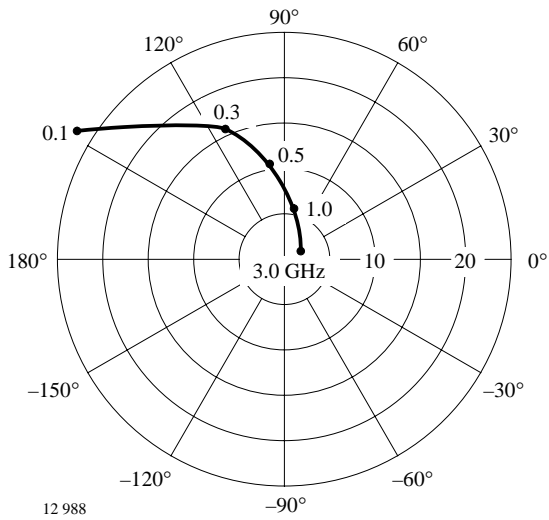

Figure 6. Forward transmission coefficient

$S_{22}$

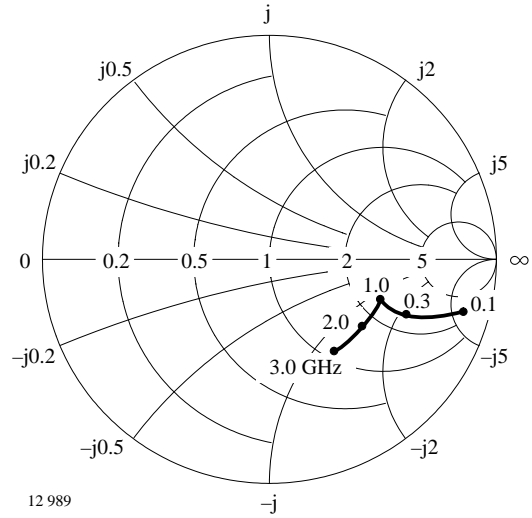
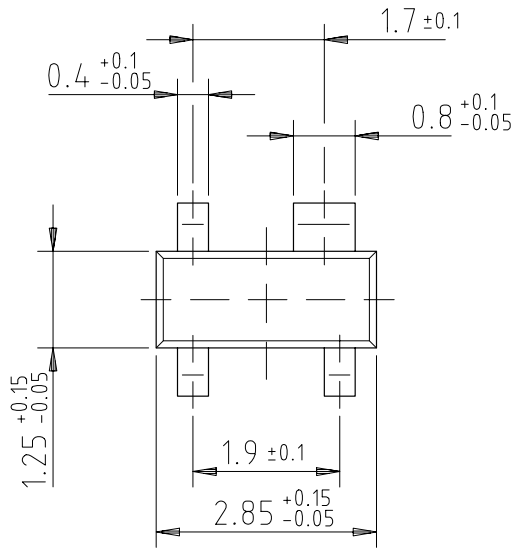
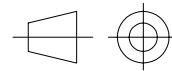

Figure 8. Output reflection coefficient

## Dimensions of BFP92A in mm



96 12240



technical drawings according to DIN specifications

## Dimensions of BFP92AW in mm

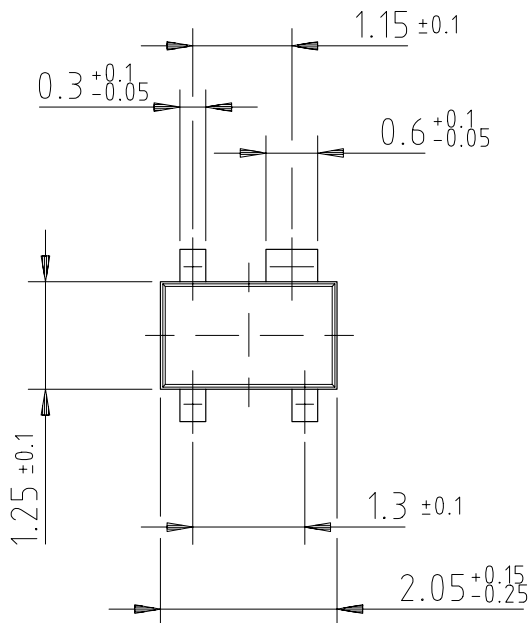

96 12237

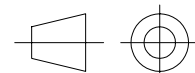

technical drawings according to DIN specifications

### Ozone Depleting Substances Policy Statement

It is the policy of **Vishay Semiconductor GmbH** to

1. Meet all present and future national and international statutory requirements.
2. Regularly and continuously improve the performance of our products, processes, distribution and operating systems with respect to their impact on the health and safety of our employees and the public, as well as their impact on the environment.

It is particular concern to control or eliminate releases of those substances into the atmosphere which are known as ozone depleting substances (ODSs).

The Montreal Protocol (1987) and its London Amendments (1990) intend to severely restrict the use of ODSs and forbid their use within the next ten years. Various national and international initiatives are pressing for an earlier ban on these substances.

**Vishay Semiconductor GmbH** has been able to use its policy of continuous improvements to eliminate the use of ODSs listed in the following documents.

1. Annex A, B and list of transitional substances of the Montreal Protocol and the London Amendments respectively
2. Class I and II ozone depleting substances in the Clean Air Act Amendments of 1990 by the Environmental Protection Agency (EPA) in the USA
3. Council Decision 88/540/EEC and 91/690/EEC Annex A, B and C (transitional substances) respectively.

**Vishay Semiconductor GmbH** can certify that our semiconductors are not manufactured with ozone depleting substances and do not contain such substances.

**We reserve the right to make changes to improve technical design and may do so without further notice.**

Parameters can vary in different applications. All operating parameters must be validated for each customer application by the customer. Should the buyer use Vishay-Telefunken products for any unintended or unauthorized application, the buyer shall indemnify Vishay-Telefunken against all claims, costs, damages, and expenses, arising out of, directly or indirectly, any claim of personal damage, injury or death associated with such unintended or unauthorized use.

Vishay Semiconductor GmbH, P.O.B. 3535, D-74025 Heilbronn, Germany  
Telephone: 49 (0)7131 67 2831, Fax number: 49 (0)7131 67 2423

This datasheet has been downloaded from:

[www.DatasheetCatalog.com](http://www.DatasheetCatalog.com)

Datasheets for electronic components.



LittleDiode supplies new, hard to find or obsolete electronic components and semiconductors all over the world.

With over two million different components listed you are sure to find the part you need.

Feel free to visit us today at our online store:

**[LittleDiode.com](http://LittleDiode.com)**

Looking forward to providing you with the best possible service.