

Variable Capacitance Diode

Description

The 1T417 is a variable capacitance diode designed for electronic tuning of BS/CS tuners using a super-small-miniature flat package (SSVC).

Features

- Super-small-miniature flat package
- Low series resistance: 1.5 Ω Max. (f=470 MHz)
- Large capacitance ratio: 15.5 Typ. (C₁/C₂₅)
- Small leakage current: 10 nA Max. (V_R=25 V)
- Capacitance deviation in a matching group: within 6 %

Applications

Electronic tuning of BS/CS tuners

Structure

Silicon epitaxial planar type diode

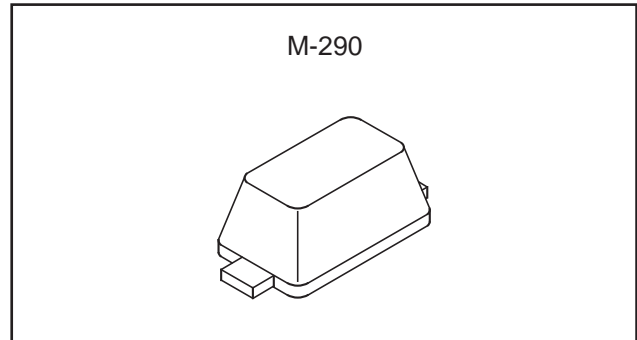

Absolute Maximum Ratings (T_a=25 °C)

- Reverse voltage V_R 30 V
- Peak reverse voltage V_{RM} 35 V (R_L ≥ 10 kΩ)
- Operating temperature T_{opr} -20 to +75 °C
- Storage temperature T_{stg} -65 to +150 °C

Electrical Characteristics

(T_a=25 °C)

Item	Symbol	Conditions	Min.	Typ.	Max.	Unit
Reverse current	I _R	V _R =25 V			10	nA
Reverse voltage	V _R	I _R =1 μA	30			V
Diode capacitance	C ₁	V _R =1 V, f=1 MHz	7.8	8.6	9.4	pF
	C ₂₅	V _R =25 V, f=1 MHz	0.5		0.6	pF
Capacitance ratio	C ₁ /C ₂₅		13.0	15.5		
Series resistance	r _s	V _R =5 V, f=470 MHz		1.30	1.50	Ω
Capacitance deviation in a matching group	ΔC	V _R =1 to 25 V, f=1 MHz			6.0	%

Sony reserves the right to change products and specifications without prior notice. This information does not convey any license by any implication or otherwise under any patents or other right. Application circuits shown, if any, are typical examples illustrating the operation of the devices. Sony cannot assume responsibility for any problems arising out of the use of these circuits.

Example of Representative Characteristics

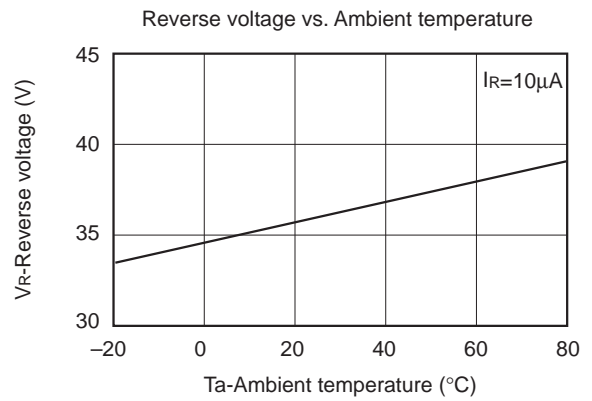
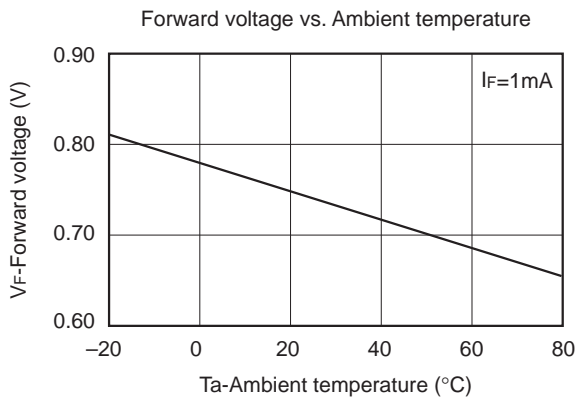
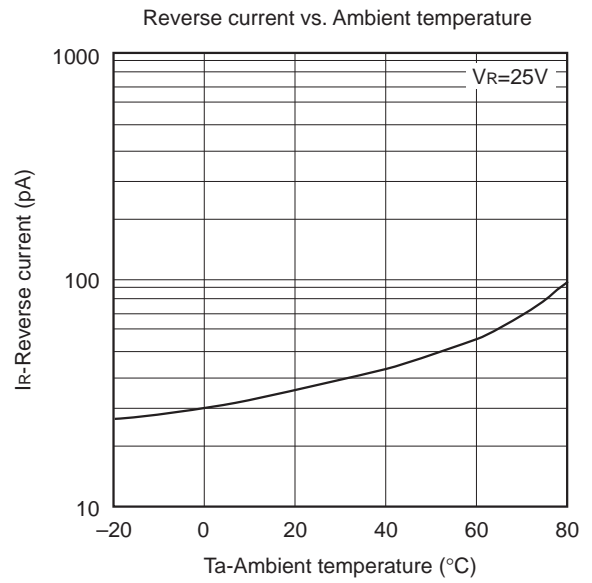
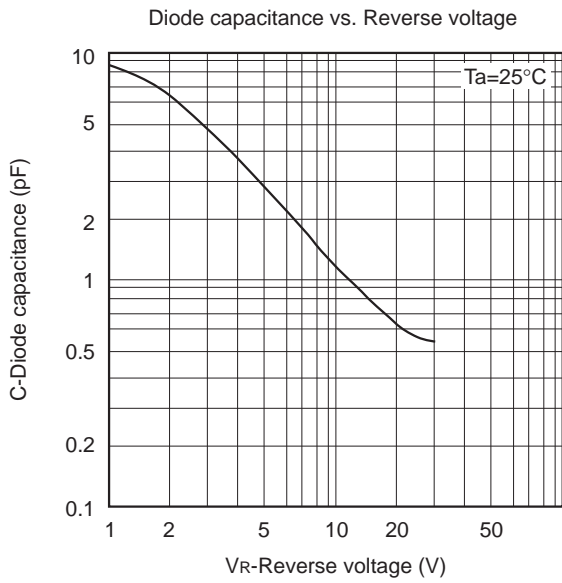

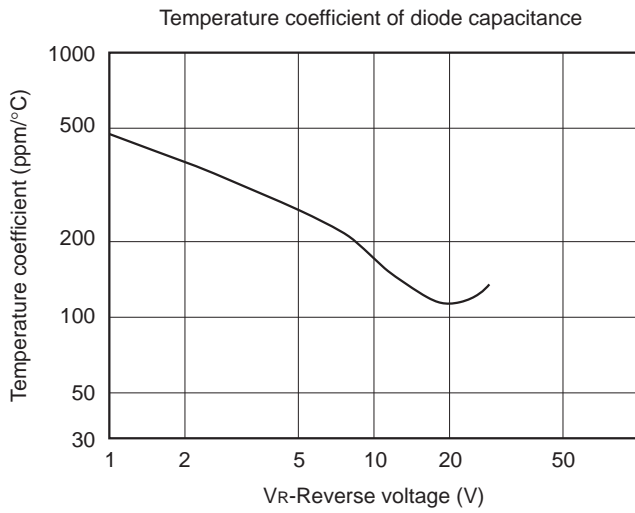
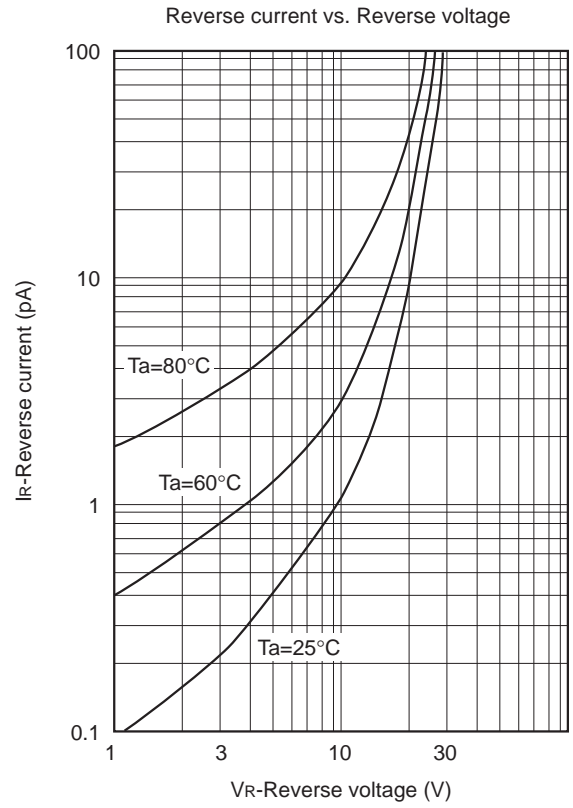
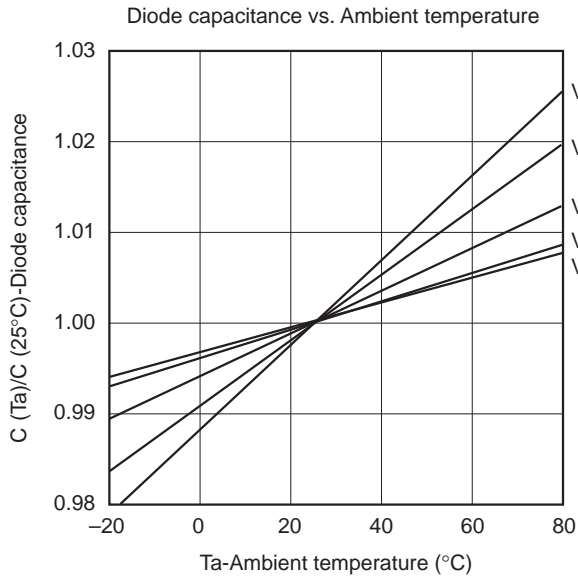

Package Outline Unit : mm

M-290

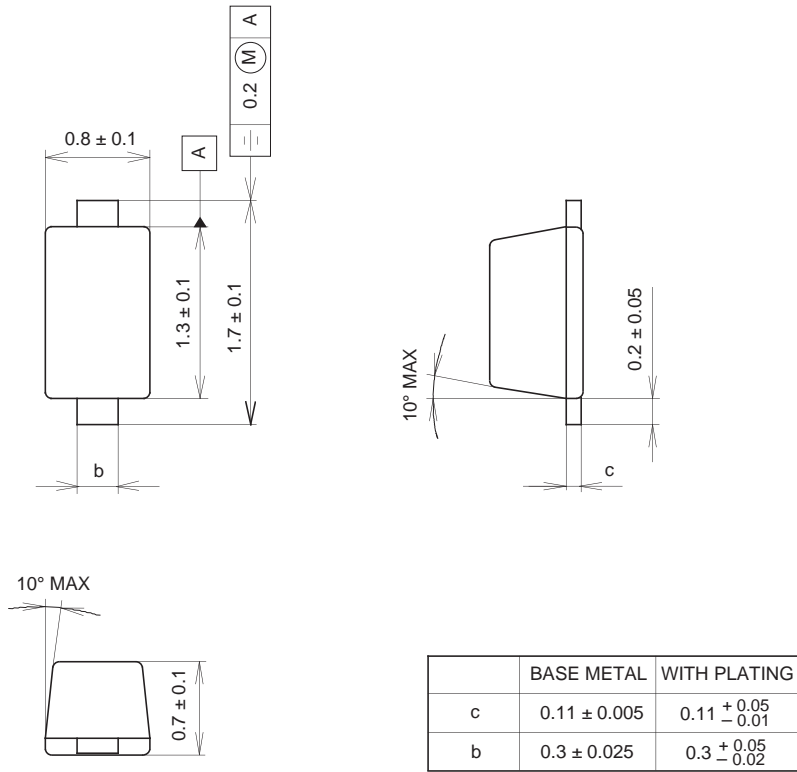

SONY CODE	M-290
EIAJ CODE	_____
JEDEC CODE	_____

PACKAGE MATERIAL	EPOXY RESIN
LEAD TREATMENT	SOLDER PLATING
LEAD MATERIAL	COPPER
PACKAGE WEIGHT	0.002g

Mark



1 : Cathode
2 : Anode



LittleDiode supplies new, hard to find or obsolete electronic components and semiconductors all over the world.

With over two million different components listed you are sure to find the part you need.

Feel free to visit us today at our online store:

LittleDiode.com

Looking forward to providing you with the best possible service.