

TOSHIBA FAST RECOVERY DIODE SILICON DIFFUSED TYPE

3BH41, 3GH41, 3JH41

HIGH SPEED RECTIFIER APPLICATIONS (FAST RECOVERY)

Unit in mm

- Average Forward Current : $I_F(AV) = 3.0A$
- Repetitive Peak Reverse Voltage : $V_{RRM} = 100 \sim 600V$
- Reverse Recovery Time : $t_{rr} = 1.5\mu s$

MAXIMUM RATING

CHARACTERISTIC	SYMBOL	RATING	UNIT
Repetitive Peak Reverse Voltage	3BH41	100	V
	3GH41	400	
	3JH41	600	
Average Forward Current	$I_F(AV)$	3.0	A
Peak One Cycle Surge Forward Current (Non Repetitive)	I_{FSM}	140	A
Junction Temperature	T_j	-40~150	°C
Storage Temperature Range	T_{stg}	-40~150	°C

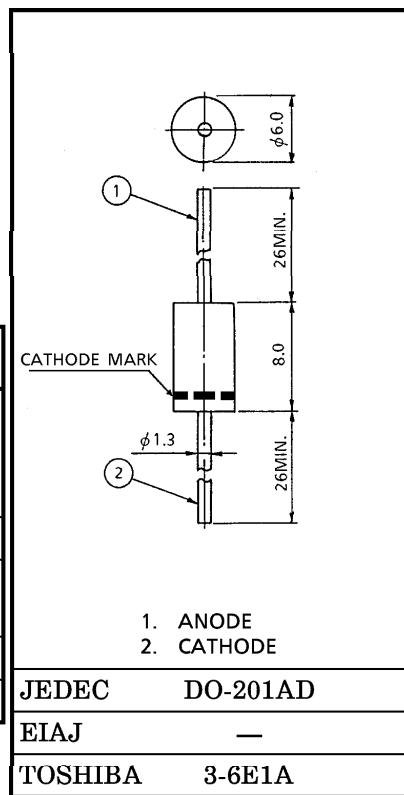

ELECTRICAL CHARACTERISTICS (Ta = 25°C)

CHARACTERISTIC	SYMBOL	TEST CONDITION	MIN.	TYP.	MAX.	UNIT
Peak Forward Voltage	V_{FM}	$I_{FM} = 3.0A$	—	—	1.2	V
Repetitive Peak Reverse Current	I_{RRM}	$V_{RRM} = \text{Rated}$	—	—	10	μA
Reverse Recovery Time	t_{rr}	$I_F = 20mA, I_R = 1mA$	—	—	1.5	μs

MARKING

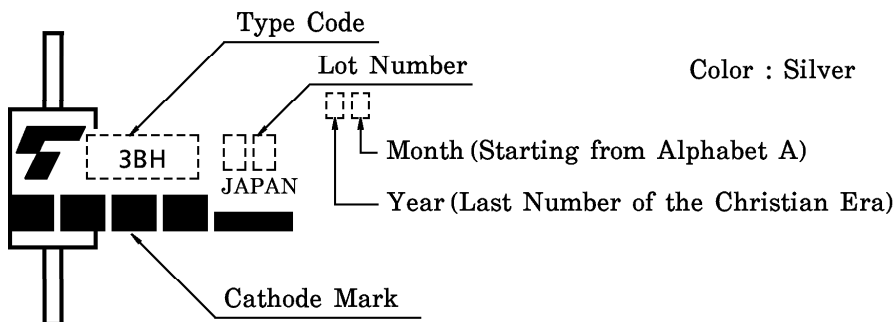

CODE	TYPE
3BH	3BH41
3GH	3GH41
3JH	3JH41

961001EAA2

- TOSHIBA is continually working to improve the quality and the reliability of its products. Nevertheless, semiconductor devices in general can malfunction or fail due to their inherent electrical sensitivity and vulnerability to physical stress. It is the responsibility of the buyer, when utilizing TOSHIBA products, to observe standards of safety, and to avoid situations in which a malfunction or failure of a TOSHIBA product could cause loss of human life, bodily injury or damage to property. In developing your designs, please ensure that TOSHIBA products are used within specified operating ranges as set forth in the most recent products specifications. Also, please keep in mind the precautions and conditions set forth in the TOSHIBA Semiconductor Reliability Handbook.
- The information contained herein is presented only as a guide for the applications of our products. No responsibility is assumed by TOSHIBA CORPORATION for any infringements of intellectual property or other rights of the third parties which may result from its use. No license is granted by implication or otherwise under any intellectual property or other rights of TOSHIBA CORPORATION or others.
- The information contained herein is subject to change without notice.

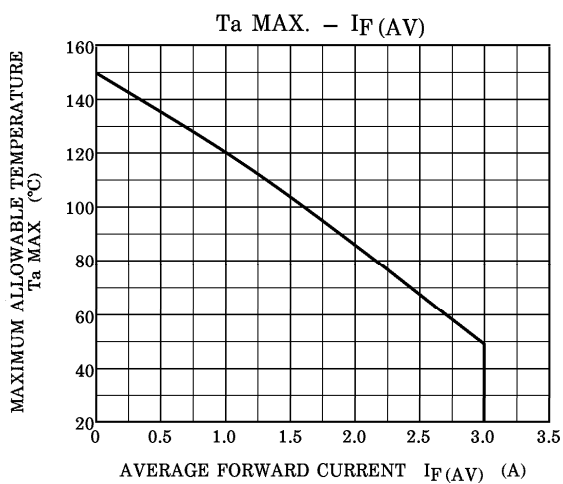
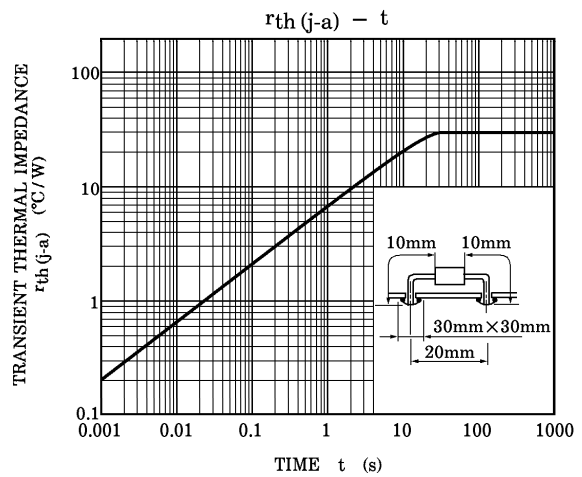
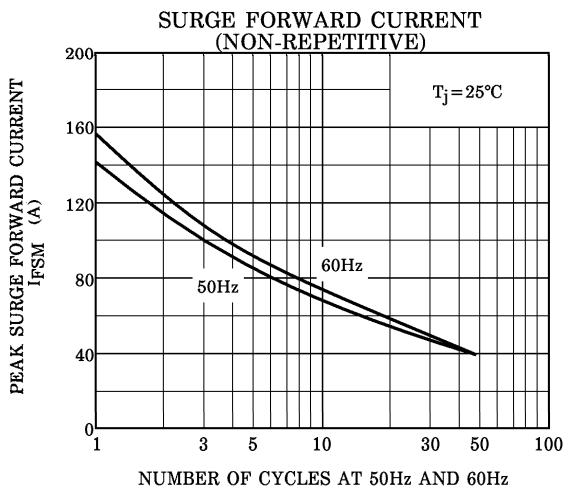
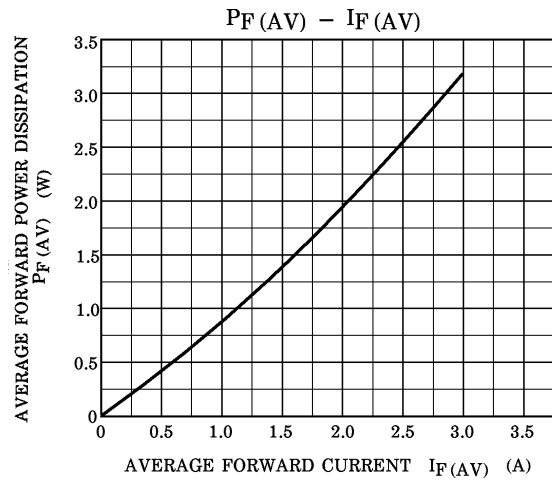
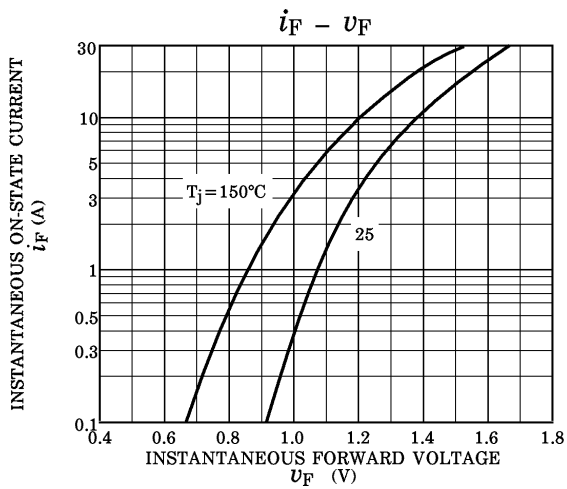

This datasheet has been downloaded from:

www.DatasheetCatalog.com

Datasheets for electronic components.



LittleDiode supplies new, hard to find or obsolete electronic components and semiconductors all over the world.

With over two million different components listed you are sure to find the part you need.

Feel free to visit us today at our online store:

LittleDiode.com

Looking forward to providing you with the best possible service.