

TOSHIBA FIELD EFFECT TRANSISTOR GaAs N-CHANNEL DUAL GATE MES TYPE

3SK283

TV TUNER, UHF RF AMPLIFIER APPLICATIONS

Unit in mm

MAXIMUM RATINGS (Ta = 25°C)

CHARACTERISTIC	SYMBOL	RATING	UNIT
Gate 1-Drain Voltage	V _{G1DO}	-6	V
Gate 2-Drain Voltage	V _{G2DO}	-6	V
Gate 1-Source Voltage	V _{G1S}	-4	V
Gate 2-Source Voltage	V _{G2S}	-4	V
Gate 1 Current	I _{G1}	1	mA
Gate 2 Current	I _{G2}	1	mA
Power Dissipation	P _D	150	mW
Channel Temperature	T _{ch}	125	°C
Storage Temperature Range	T _{stg}	-55~125	°C

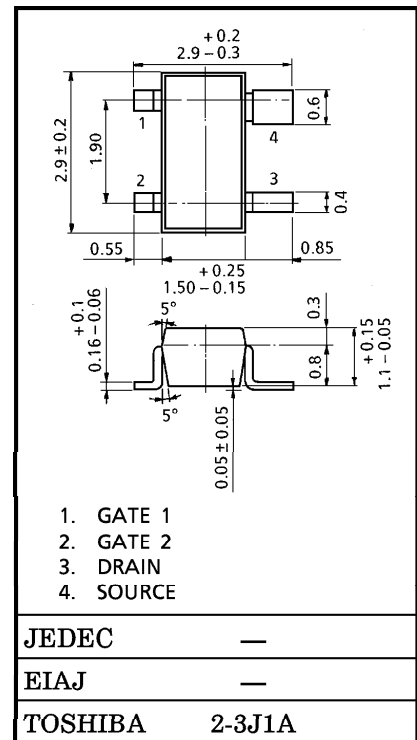

Marking

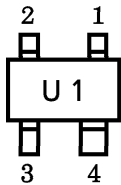

ELECTRICAL CHARACTERISTICS (Ta = 25°C)

Weight : 0.013g

CHARACTERISTIC	SYMBOL	TEST CONDITION	MIN.	TYP.	MAX.	UNIT
Gate 1 Leakage Current	I _{G1SS}	V _{DS} =0, V _{G1S} =-3V, V _{G2S} =0	—	—	-4	μA
Gate 2 Leakage Current	I _{G2SS}	V _{DS} =0, V _{G1S} =0, V _{G2S} =-3V	—	—	-4	μA
Drain Current	I _{DSS}	V _{DS} =2V, V _{G1S} =0, V _{G2S} =0	4	—	16	mA
Gate 1-Source Cut-off Voltage	V _{G1S (OFF)}	V _{DS} =2V, V _{G2S} =0, I _D =100μA	-0.5	—	-1.5	V
Gate 2-Source Cut-off Voltage	V _{G2S (OFF)}	V _{DS} =2V, V _{G1S} =0, I _D =100μA	-0.5	—	-1.5	V
Forward Transfer Admittance	Y _{fs}	V _{DS} =2V, V _{G2S} =0.5V, I _D =2mA, f=1kHz	—	12	—	mS
Input Capacitance	C _{iss}	V _{DS} =2V, V _{G2S} =0.5V, I _D =2mA, f=1MHz	—	0.65	1.3	pF
Reverse Transfer Capacitance	C _{rss}		—	0.015	0.03	
Power Gain	G _{ps}	V _{DS} =2V, V _{G2S} =0.5V, I _D =2mA, f=800MHz (Fig.1)	15	18.5	—	dB
Noise Figure	NF		—	1.3	2.5	

CAUTION

GaAs (Gallium Arsenide) is used in this product. The dust or vapor can be dangerous to humans. Do not break, cut, crush or dissolve chemically. Dispose of this product properly according to law. Do not intermingle with normal industrial or domestic waste.

961001EAC2

- TOSHIBA is continually working to improve the quality and the reliability of its products. Nevertheless, semiconductor devices in general can malfunction or fail due to their inherent electrical sensitivity and vulnerability to physical stress. It is the responsibility of the buyer, when utilizing TOSHIBA products, to observe standards of safety, and to avoid situations in which a malfunction or failure of a TOSHIBA product could cause loss of human life, bodily injury or damage to property. In developing your designs, please ensure that TOSHIBA products are used within specified operating ranges as set forth in the most recent products specifications. Also, please keep in mind the precautions and conditions set forth in the TOSHIBA Semiconductor Reliability Handbook.
- Gallium arsenide (GaAs) is a substance used in the products described in this document. GaAs dust and fumes are toxic. Do not break, cut or pulverize the product, or use chemicals to dissolve them. When disposing of the products, follow the appropriate regulations. Do not dispose of the products with other industrial waste or with domestic garbage.
- The information contained herein is presented only as a guide for the applications of our products. No responsibility is assumed by TOSHIBA CORPORATION for any infringements of intellectual property or other rights of the third parties which may result from its use. No license is granted by implication or otherwise under any intellectual property or other rights of TOSHIBA CORPORATION or others.
- The information contained herein is subject to change without notice.

Fig.1 800MHz G_{ps} , NF TEST CIRCUIT

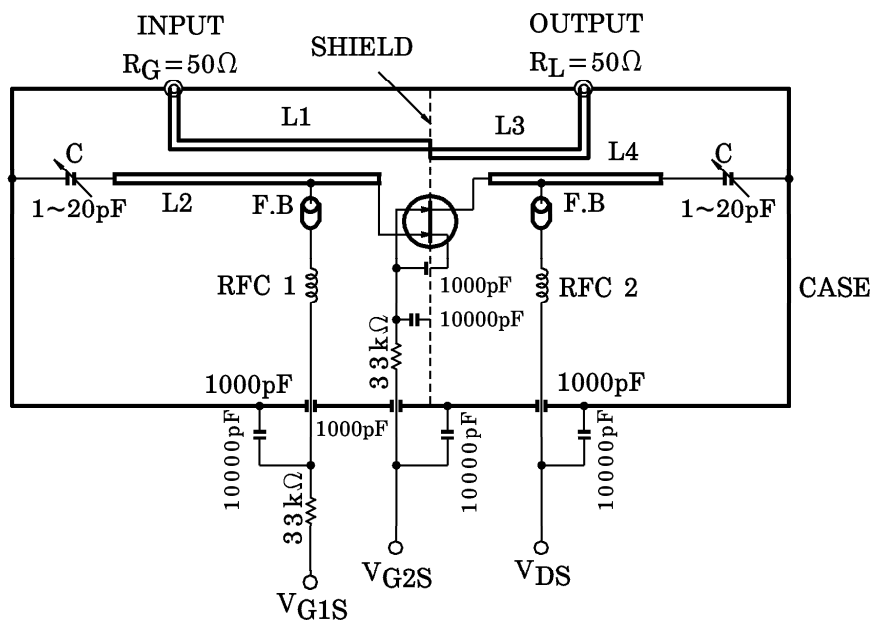

L1~L4 : ϕ 1.0mm SILVER PLATED COPPER WIRE

C : AIR TRIMMER TTA25A200A (MURATA MFG. Co., LTD.)

RFC 1 : ϕ 0.35mm COPPER WIRE 3mm ID, 7T

RFC 2 : ϕ 0.35mm COPPER WIRE 3mm ID, 10T

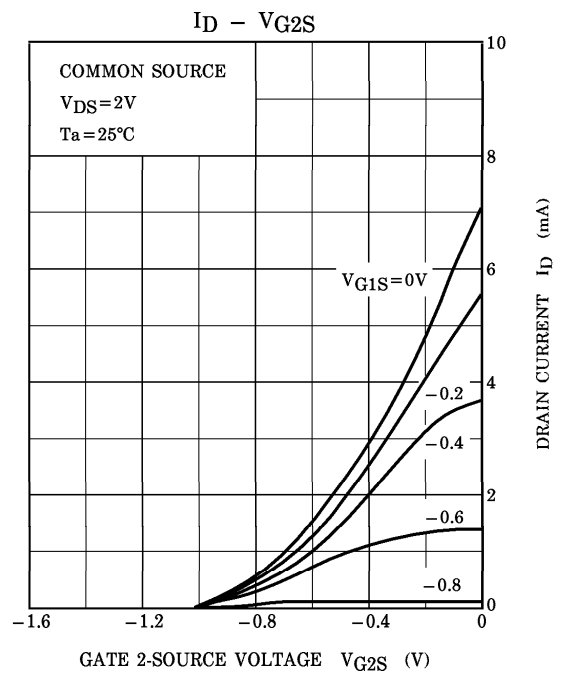
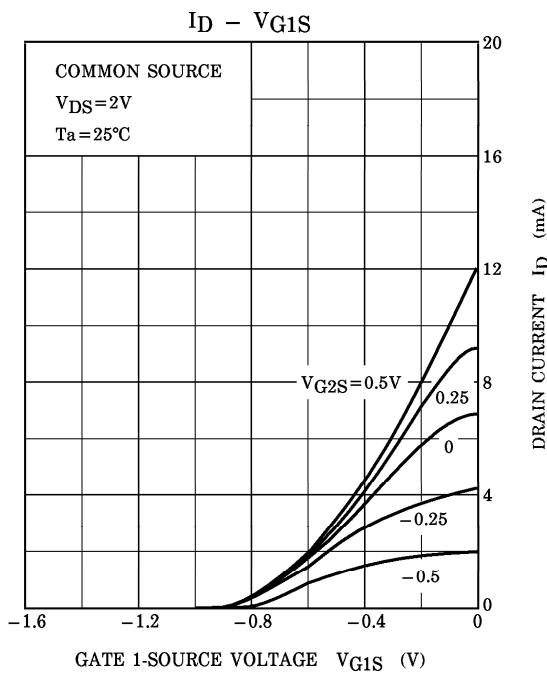
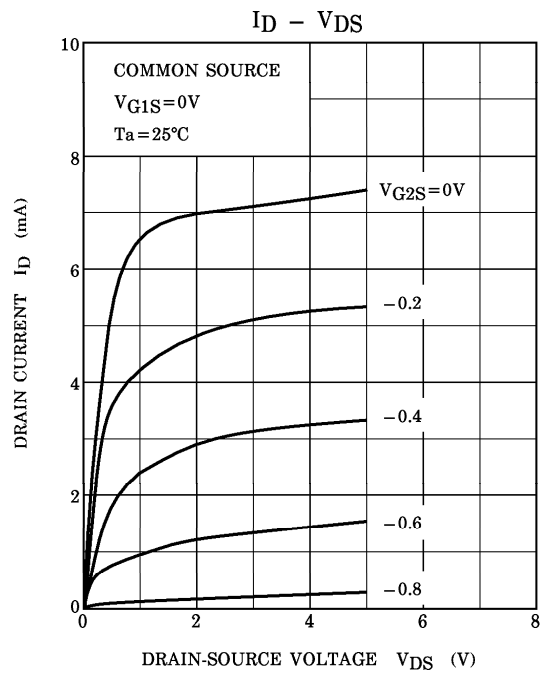
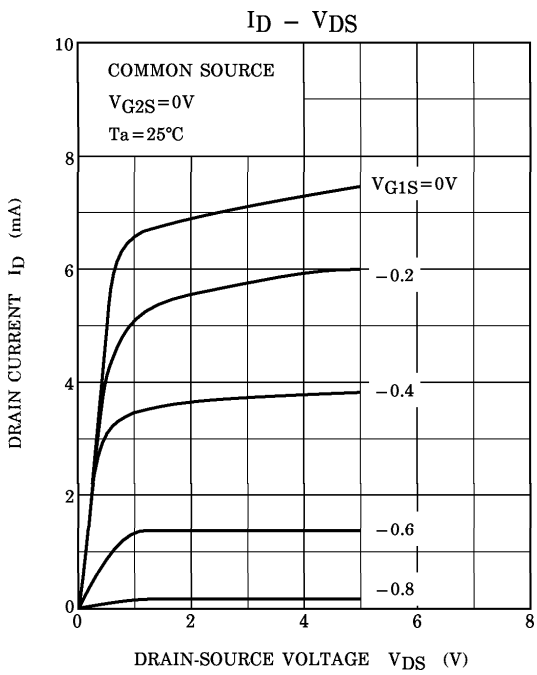

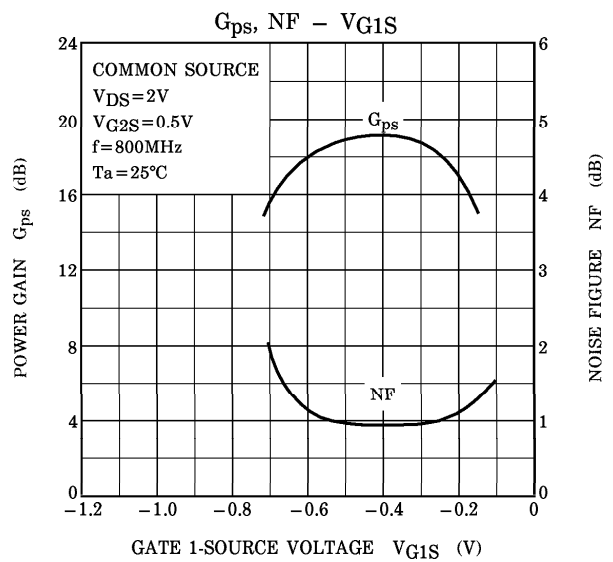
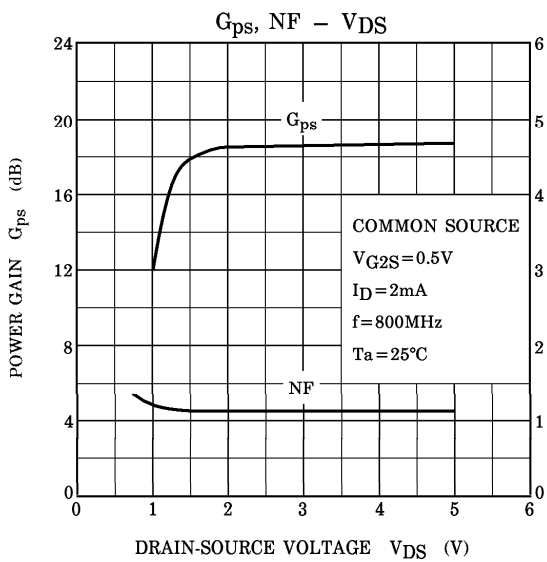
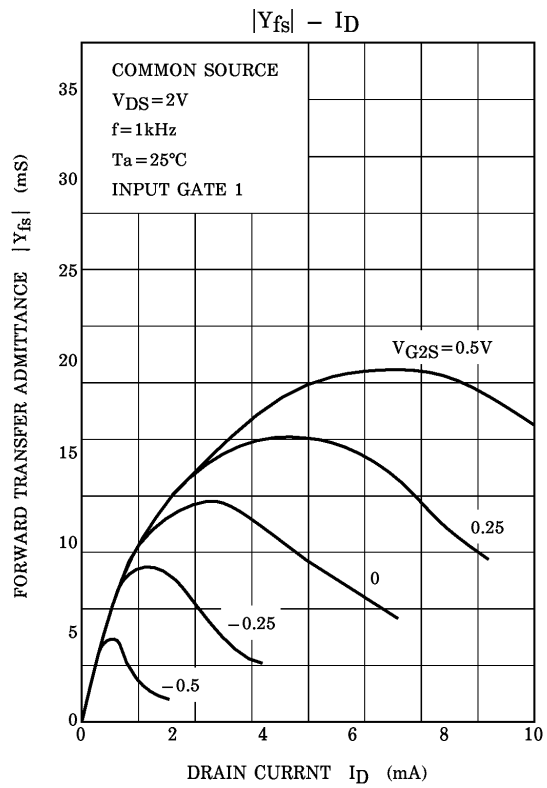
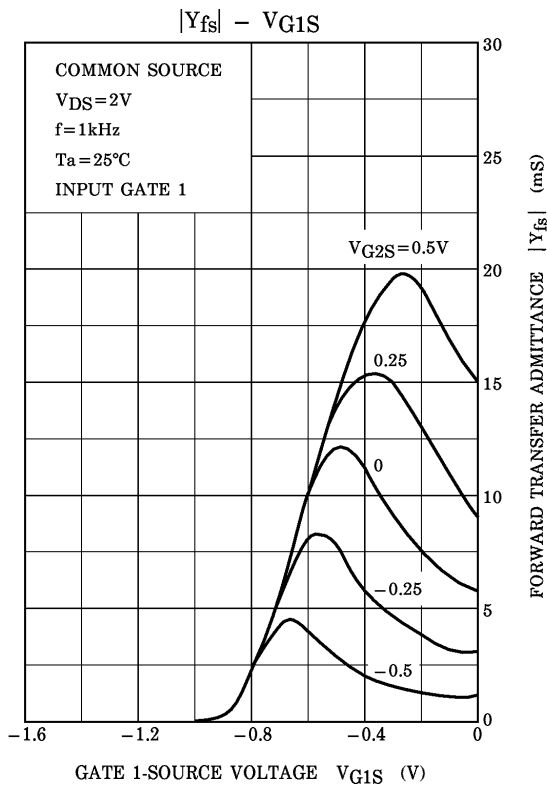

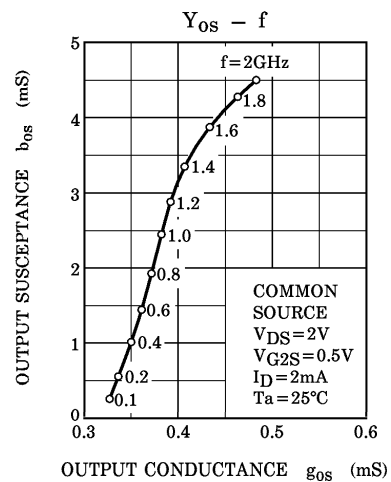
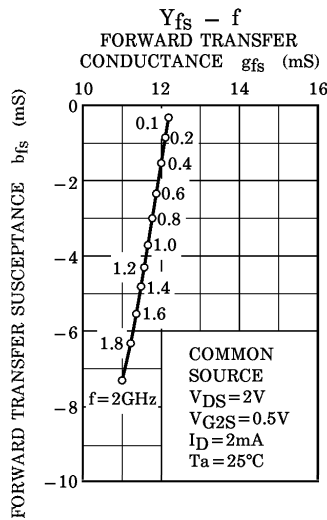
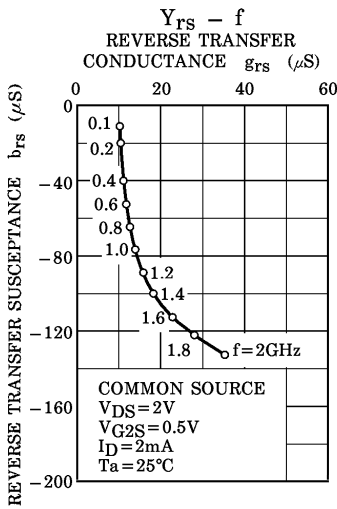
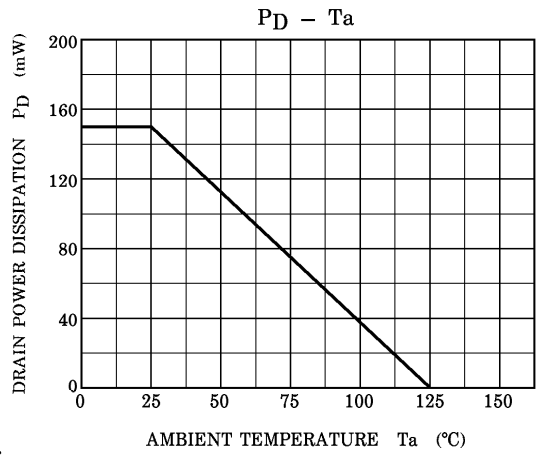
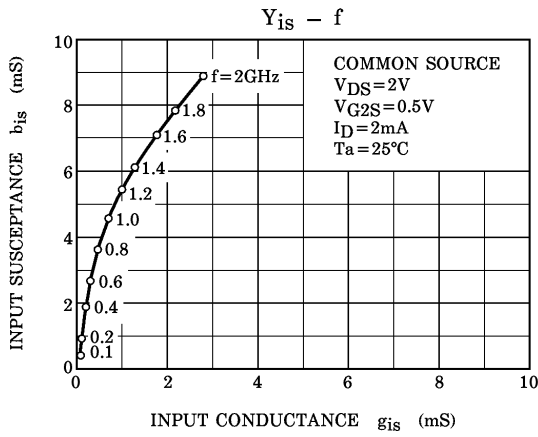
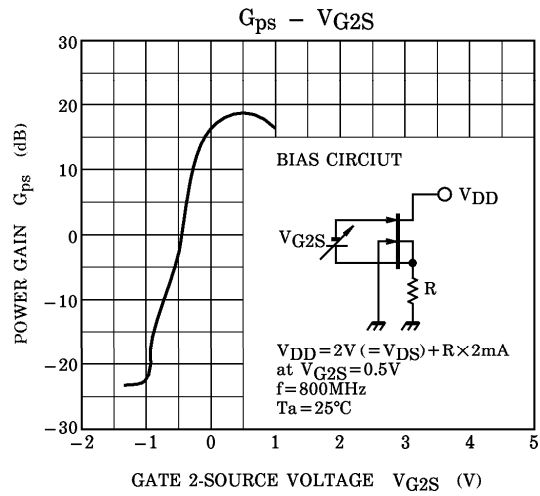
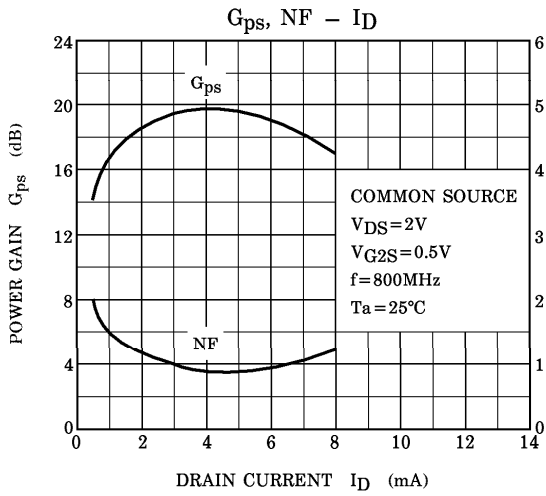

This datasheet has been downloaded from:

www.DatasheetCatalog.com

Datasheets for electronic components.



LittleDiode supplies new, hard to find or obsolete electronic components and semiconductors all over the world.

With over two million different components listed you are sure to find the part you need.

Feel free to visit us today at our online store:

LittleDiode.com

Looking forward to providing you with the best possible service.