

TOSHIBA HIGH EFFICIENCY DIODE STACK (HED) SILICON EPITAXIAL TYPE

16DL2CZ47A, 16FL2CZ47A

SWITCHING MODE POWER SUPPLY APPLICATION
CONVERTER & CHOPPER APPLICATION

Unit: mm

- Repetitive Peak Reverse Voltage : $V_{RRM} = 200, 300V$
- Average Output Rectified Current : $I_O = 16A$
- Ultra Fast Reverse-Recovery Time : $t_{rr} = 35ns$ (Max)
- Low Switching Losses and Output Noise.

MAXIMUM RATINGS ($T_a = 25^\circ C$)

CHARACTERISTIC		SYMBOL	RATING	UNIT
Repetitive Peak Reverse Voltage	16DL2CZ47A	V_{RRM}	200	V
	16FL2CZ47A		100	
Average Output Rectified Current (Full Sine Waveform)		I_O	16	A
Peak One Cycle Surge Forward Current (Non-Repetitive)		I_{FSM}	80 (50Hz)	A
			88 (60Hz)	
Junction Temperature		T_j	-40~150	$^\circ C$
Storage Temperature Range		T_{stg}	-40~150	$^\circ C$
Screw Torque		—	0.6	N·m

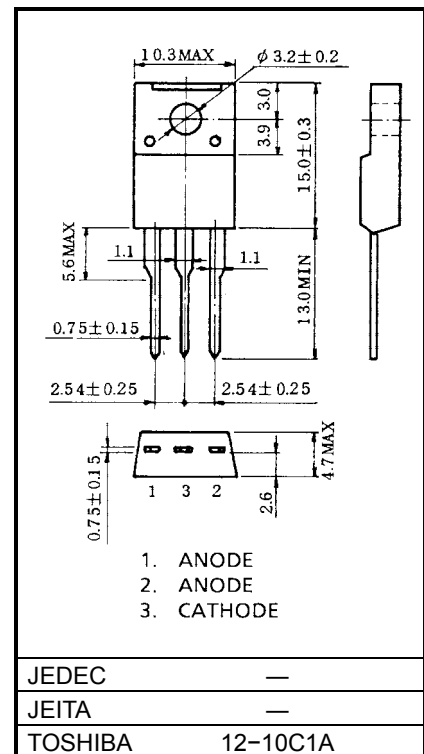

Weight: 2.0g

ELECTRICAL CHARACTERISTICS ($T_a = 25^\circ C$)

CHARACTERISTIC		SYMBOL	TEST CONDITION	MIN	TYP.	MAX	UNIT
Peak Forward Voltage (Note 1)	16DL2CZ47A	V_{FM}	$I_{FM} = 8A$	—	—	0.98	V
	16FL2CZ47A			—	—	1.3	
Repetitive Peak Reverse Current (Note 1)		I_{RRM}	$V_{RRM} = \text{Rated}$	—	—	50	μA
Reverse Recovery Time (Note 1)		t_{rr}	$I_F = 2.0A, di / dt = -50A / \mu s$	—	—	35	ns
Forward Recovery Time (Note 1)		t_{fr}	$I_F = 1.0A$	—	—	100	ns
Thermal Resistance		$R_{th(j-c)}$	DC Total, Junction to Case	—	—	3.3	$^\circ C / W$

Note 1: A value of one cell.

POLARITY

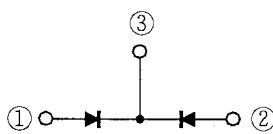

MARKING

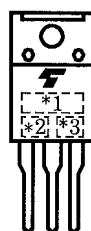

* 1	MARK	16DL2CZ	TYPE	16DL2CZ47A
		16FL2CZ		16FL2CZ47A
* 2	A			
* 3	Lot Number			
	□□ -Month (Starting from Alphabet A)			
	—Year (Last Number of the Christian Era)			

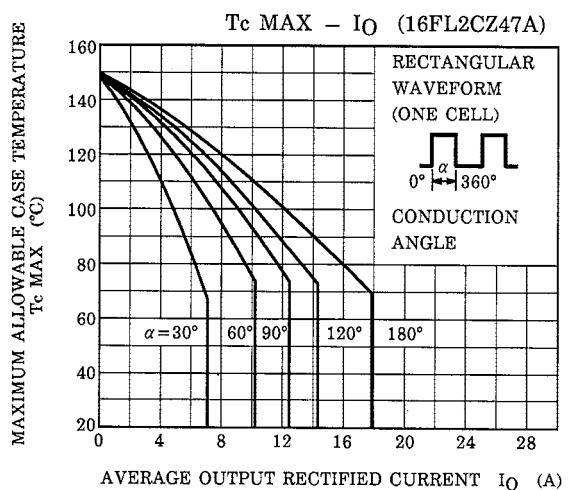
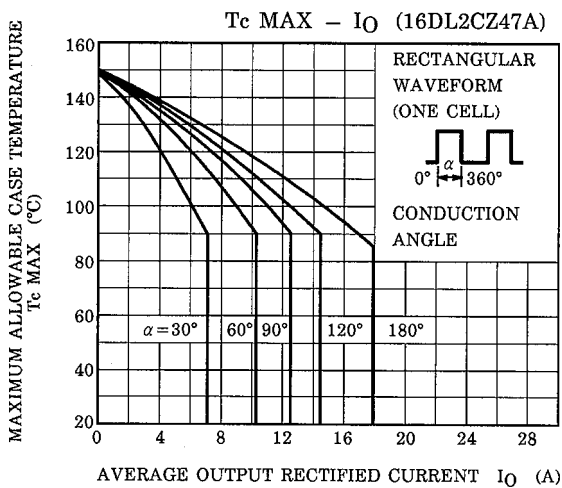
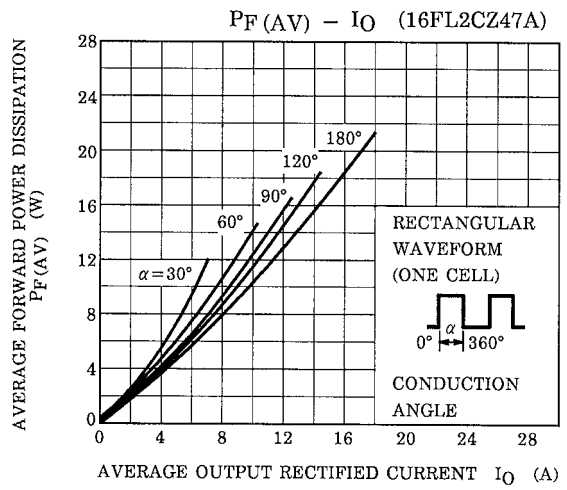
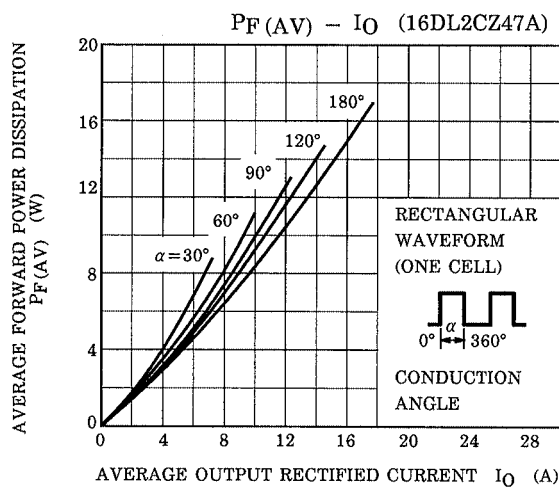
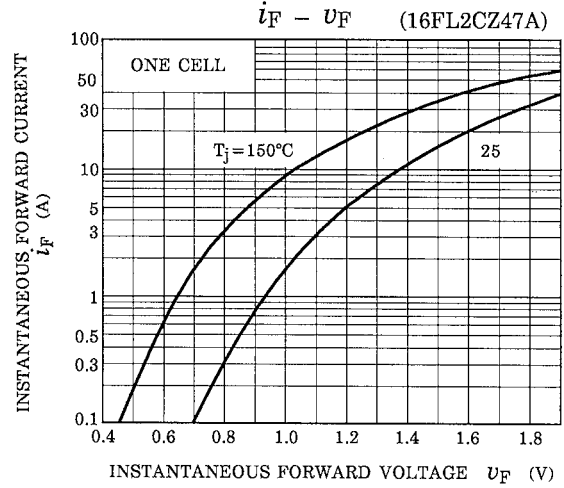
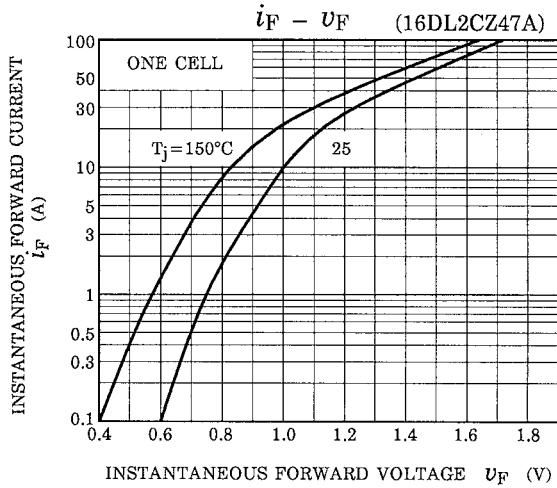

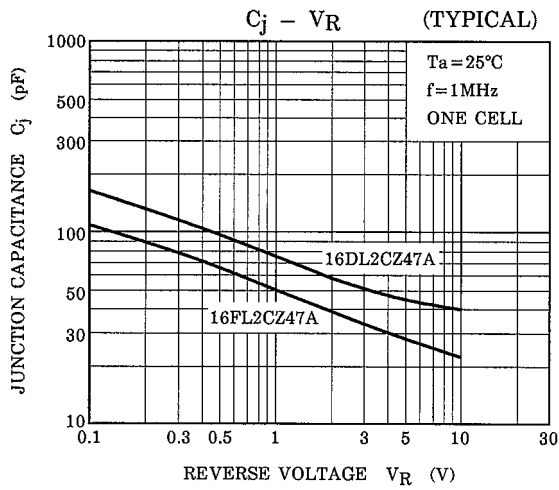
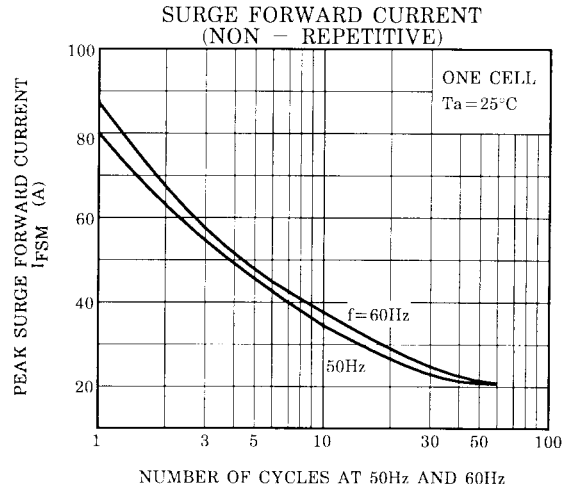
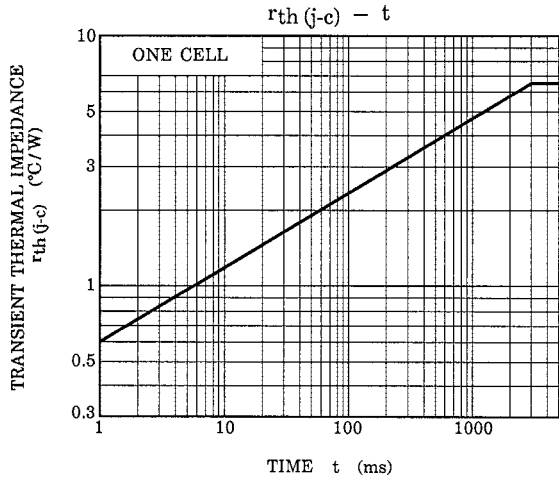

RESTRICTIONS ON PRODUCT USE

000707EAA

- TOSHIBA is continually working to improve the quality and reliability of its products. Nevertheless, semiconductor devices in general can malfunction or fail due to their inherent electrical sensitivity and vulnerability to physical stress. It is the responsibility of the buyer, when utilizing TOSHIBA products, to comply with the standards of safety in making a safe design for the entire system, and to avoid situations in which a malfunction or failure of such TOSHIBA products could cause loss of human life, bodily injury or damage to property.
In developing your designs, please ensure that TOSHIBA products are used within specified operating ranges as set forth in the most recent TOSHIBA products specifications. Also, please keep in mind the precautions and conditions set forth in the "Handling Guide for Semiconductor Devices," or "TOSHIBA Semiconductor Reliability Handbook" etc..
- The TOSHIBA products listed in this document are intended for usage in general electronics applications (computer, personal equipment, office equipment, measuring equipment, industrial robotics, domestic appliances, etc.). These TOSHIBA products are neither intended nor warranted for usage in equipment that requires extraordinarily high quality and/or reliability or a malfunction or failure of which may cause loss of human life or bodily injury ("Unintended Usage"). Unintended Usage include atomic energy control instruments, airplane or spaceship instruments, transportation instruments, traffic signal instruments, combustion control instruments, medical instruments, all types of safety devices, etc.. Unintended Usage of TOSHIBA products listed in this document shall be made at the customer's own risk.
- The information contained herein is presented only as a guide for the applications of our products. No responsibility is assumed by TOSHIBA CORPORATION for any infringements of intellectual property or other rights of the third parties which may result from its use. No license is granted by implication or otherwise under any intellectual property or other rights of TOSHIBA CORPORATION or others.
- The information contained herein is subject to change without notice.



LittleDiode supplies new, hard to find or obsolete electronic components and semiconductors all over the world.

With over two million different components listed you are sure to find the part you need.

Feel free to visit us today at our online store:

LittleDiode.com

Looking forward to providing you with the best possible service.