

Surface Mount Chip LEDs

Technical Data

HSMB-C190/C170/ C110/C150/C191

Features

- **Small Size**
- **Industry Standard Footprint**
- **Compatible with IR Solder**
- **Diffused Optics**
- **Operating Temperature Range of -30°C to +85°C**
- **Right Angle Package Available**
- **SiC Blue Color**
- **Available in 8 mm Tape on 7" (178 mm) Diameter Reels**

Applications

- **Keypad Backlighting**
- **Push-Button Backlighting**
- **LCD Backlighting**
- **Symbol Backlighting**
- **Front Panel Indicator**

Description

These Blue chip LEDs are designed in an industry standard package for ease of handling and use. Blue color chip LED is a new product that offers color differentiation for backlighting applications.

The HSMB-C150 has the industry standard 3.2 x 1.6 mm footprint that is excellent for all around use. The HSMB-C170 has the widely used 2.0 x 1.25 mm footprint. The HSMB-C190 and HSMB-C191 have the industry standard 1.6 x 0.8 mm footprint, and their low profiles (0.8 mm for HSMB-C190 and 0.6 mm for HSMB-C191) and wide viewing angles make these LEDs exceptional for backlighting applications.



The HSMB-C110 is a right-angle package with the universally accepted dimensions of 3.2 x 1.0 x 1.5 mm. This part is ideal for LCD backlighting and sidelighting applications.

All packages are compatible with IR reflow solder processes. The small size and wide viewing angle make these LEDs prime choices for backlighting applications and front panel illumination especially where space is a premium.

Device Selection Guide

Footprint (mm)	SiC Blue	Parts Per Reel
2.00 x 1.25	HSMB-C170	4000
1.60 x 0.80	HSMB-C190/C191	4000
3.20 x 1.00 ^[1]	HSMB-C110	3000
3.20 x 1.60	HSMB-C150	3000

Note:

1. Right-angle package.

CAUTION: HSMB-C1xx LEDs are Class 1 ESD sensitive per MIL-STD-1686. Please observe appropriate precautions during handling and processing. Refer to Agilent Technologies Application Note AN-1142 for additional details.

Package Dimensions

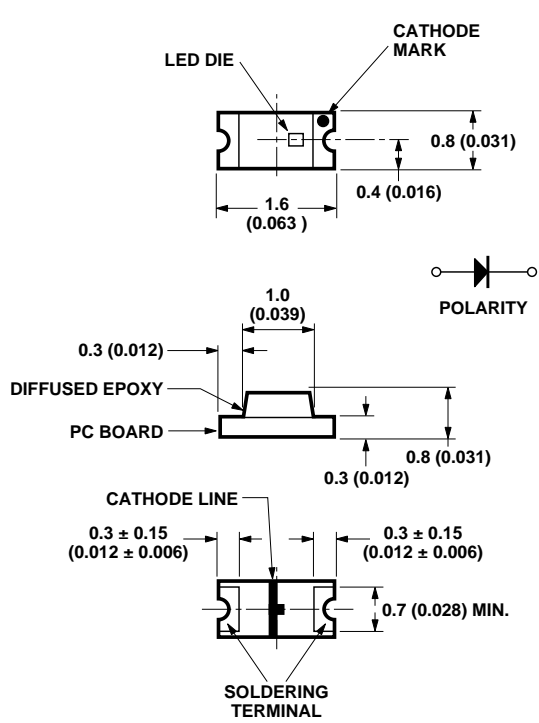

HSMB-C190

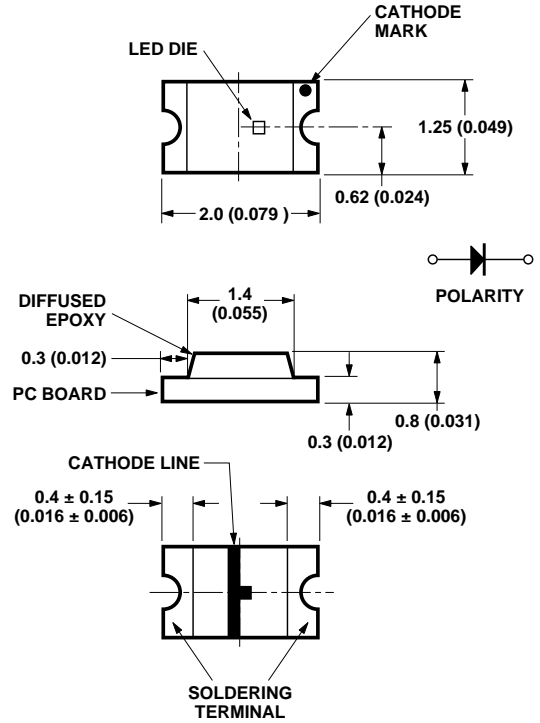

HSMB-C170

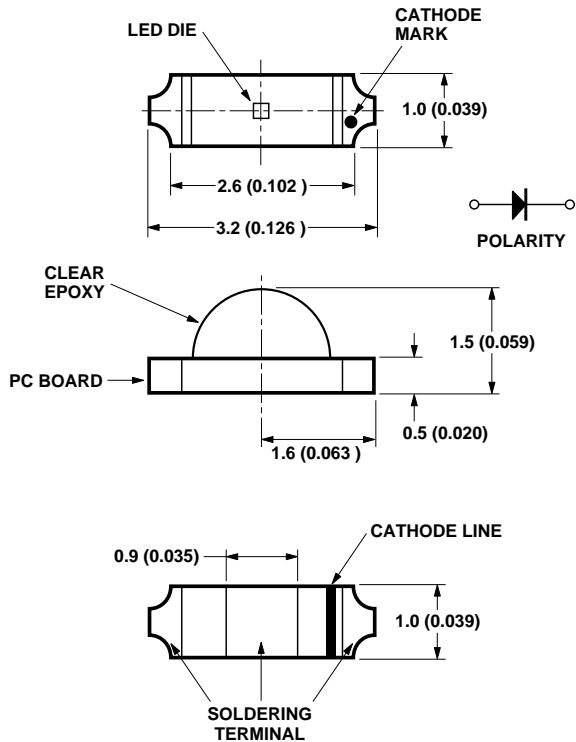

HSMB-C110

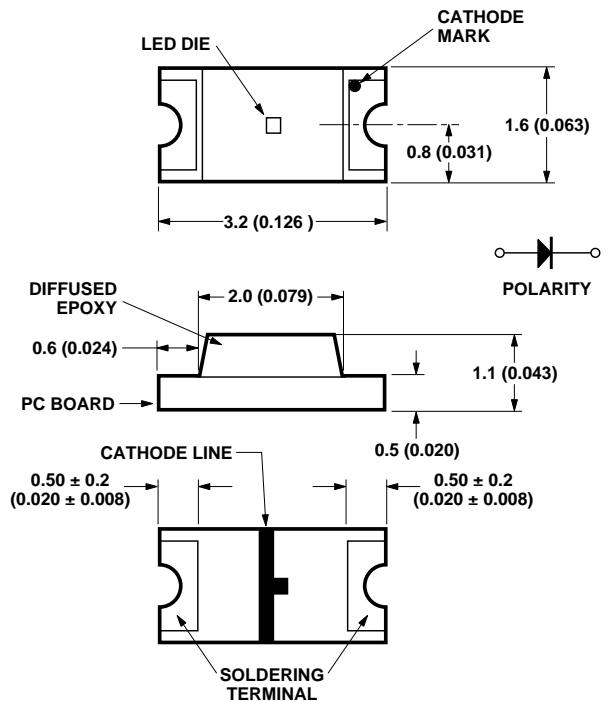

HSMB-C150

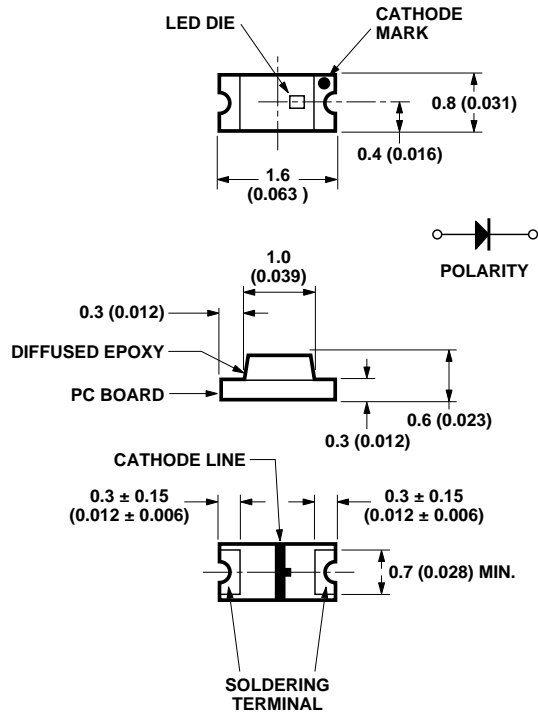

HSMB-C191

NOTES:

1. ALL DIMENSIONS IN MILLIMETERS (INCHES).
2. TOLERANCE IS ± 0.1 mm (± 0.004 IN.) UNLESS OTHERWISE SPECIFIED.

Absolute Maximum Ratings at $T_A = 25^\circ\text{C}$

Parameter	HSMB-C190/C170/C110/C150/C191	Units
DC Forward Current ^[1]	20	mA
Peak Pulsing Current ^[2]	100	mA
Power Dissipation	92	mW
Reverse Voltage ($I_R = 100 \mu\text{A}$)	5	V
Maximum LED Junction Temperature	95	$^\circ\text{C}$
Operating Temperature Range	-30 to +85	$^\circ\text{C}$
Storage Temperature Range	-40 to +85	$^\circ\text{C}$
Soldering Temperature	See IR soldering profile (Figure 7)	

Notes:

1. Derate linearly as shown in Figure 4 for temperature above 25°C .
2. Pulse condition of 1/10 duty and 0.1 msec. width.

Optical Characteristics at $T_A=25^\circ\text{C}$

Part No.	Color	Luminous Intensity ^[1] I_v (mcd) @ 20 mA		Peak Wavelength λ_{peak} (nm)	Dominant Wavelength λ_d (nm)	Viewing Angle $2\theta_{1/2}$ (degrees) ^[2]
		Min.	Typ.	Typ.	Typ.	Typ.
HSMB-C190/C170/C150/C191	SiC Blue	1.60	6.0	428	466	170
HSMB-C110	SiC Blue	1.60	6.5	428	466	130

Notes:

1. The luminous intensity, I_v , is measured at the peak of the spatial radiation pattern, which may not be aligned with the mechanical axis of the lamp package.
2. $\theta_{1/2}$ is the off-axis angle where the luminous intensity is 1/2 the peak intensity.

Electrical Characteristics at $T_A=25^\circ\text{C}$

Part No.	Forward Voltage V_F (Volts) @ $I_F = 20$ mA		Reverse Breakdown V_R (Volts) @ $I_R = 100$ μA	Thermal Resistance $R_{\theta_{J-P}}$ ($^\circ\text{C}/\text{W}$)	Capacitance C (pF) @ $V_F = 0$ V, $f = 1$ MHz
	Typ.	Max.	Min.	Typ.	Typ.
HSMB-C190/C170/C150/C191	3.8	4.6	5	300	67
HSMB-C110	3.8	4.6	5	300	67

V_F Tolerance: ± 0.1 V

Bin ID	Blue Color Bins ^[1]	
	Dom. Wavelength (nm)	
	Min.	Max.
A	460.0	465.0
B	465.0	470.0
C	470.0	475.0
D	475.0	480.0

Tolerance: ± 1 nm

Bin ID	InGaN Green Color Bins ^[1]	
	Dom. Wavelength (nm)	
	Min.	Max.
A	515.0	520.0
B	520.0	525.0
C	525.0	530.0
D	530.0	535.0

Tolerance: ± 1 nm

Note:

1. Bin categories are established for classification of products. Products may not be available in all categories. Please contact your Agilent representative for information on currently available bins.

Light Intensity (I_v) Bin Limits^[1]

Bin ID	Intensity (mcd)		Bin ID	Intensity (mcd)	
	Min.	Max.		Min.	Max.
A	0.11	0.18	N	28.50	45.00
B	0.18	0.29	P	45.00	71.50
C	0.29	0.45	Q	71.50	112.50
D	0.45	0.72	R	112.50	180.00
E	0.72	1.10	S	180.00	285.00
F	1.10	1.80	T	285.00	450.00
G	1.80	2.80	U	450.00	715.00
H	2.80	4.50	V	715.00	1125.00
J	4.50	7.20	W	1125.00	1800.00
K	7.20	11.20	X	1800.00	2850.00
L	11.20	18.00	Y	2850.00	4500.00
M	18.00	28.50			

Tolerance: $\pm 15\%$

Note:

1. Bin categories are established for classification of products. Products may not be available in all categories. Please contact your Agilent representative for information on currently available bins.

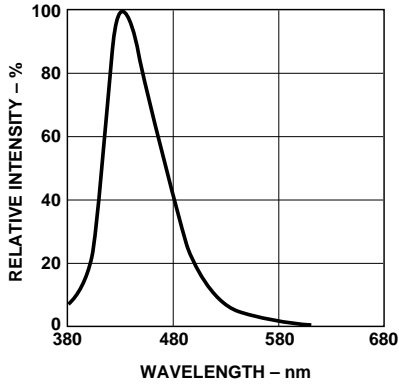

Figure 1. Relative Intensity vs. Wavelength.

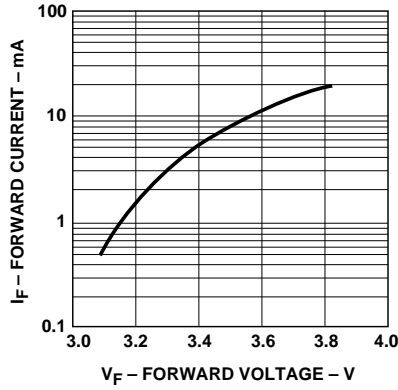

Figure 2. Forward Current vs. Forward Voltage.

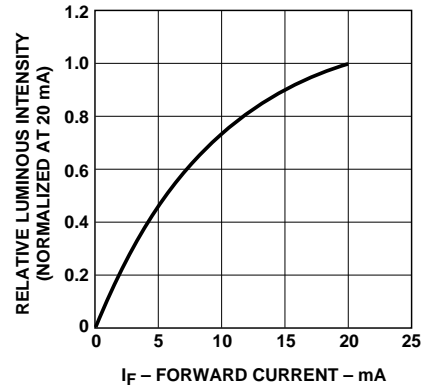

Figure 3. Relative Luminous Intensity vs. Forward Current.

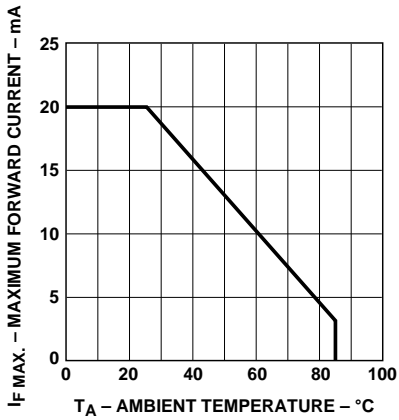

Figure 4. Maximum Forward Current vs. Ambient Temperature.

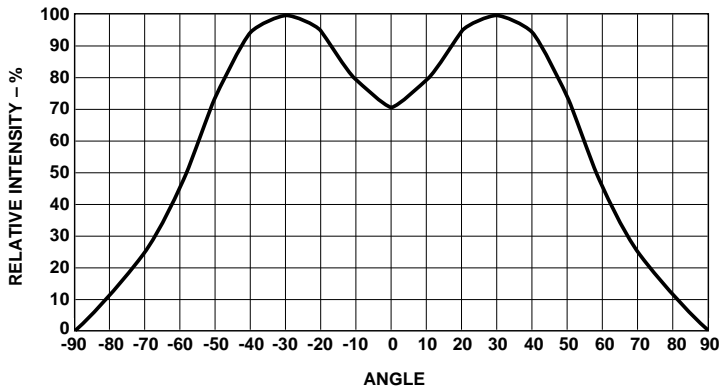
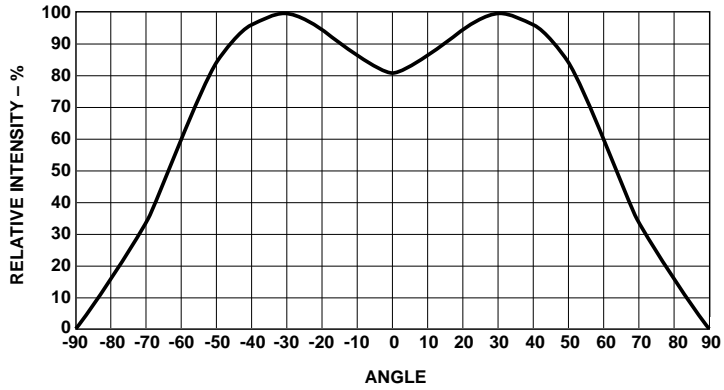

Figure 5. Relative Intensity vs. Angle for HSMB-C110.

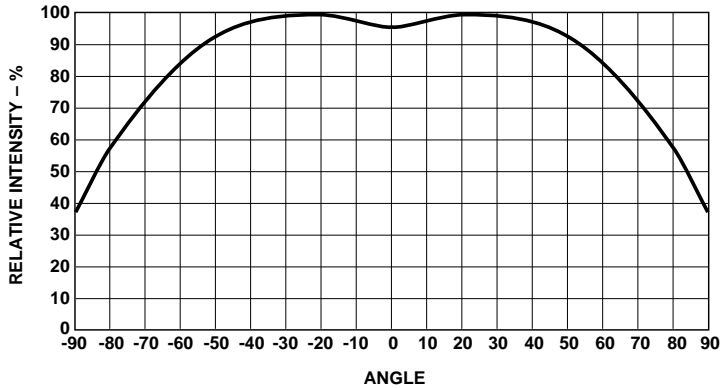

Figure 6. Relative Intensity vs. Angle for HSMB-C170, HSMB-C190, HSMB-C150, and HSMB-C191.

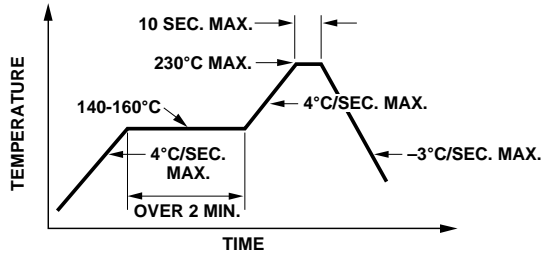

Figure 7. Recommended Reflow Soldering Profile.

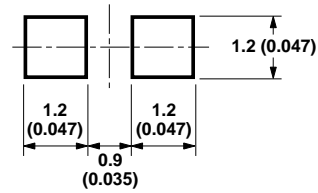

Figure 8. Recommended Soldering Pattern for HSMB-C170.

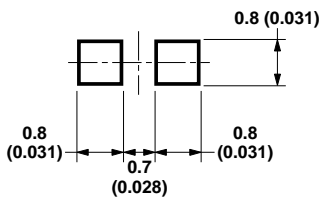

Figure 9. Recommended Soldering Pattern for HSMB-C190 and C191.

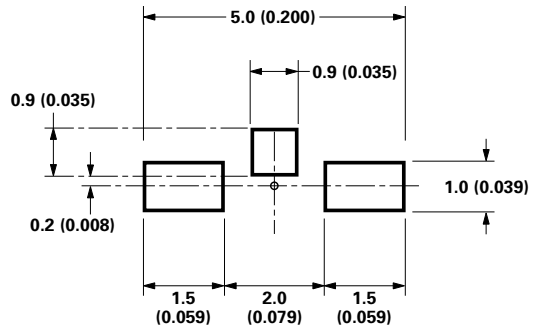

Figure 10. Recommended Soldering Pattern for HSMB-C110.

Note:

1. All dimensions in millimeters (inches).

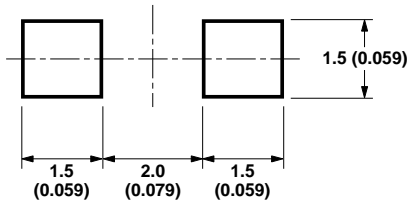

Figure 11. Recommended Soldering Pattern for HSMB-C150.

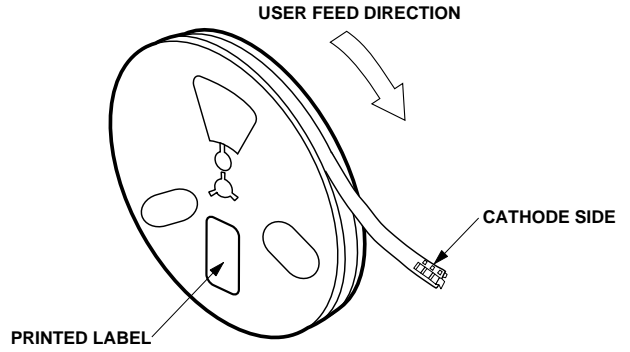

Figure 12. Reeling Orientation.

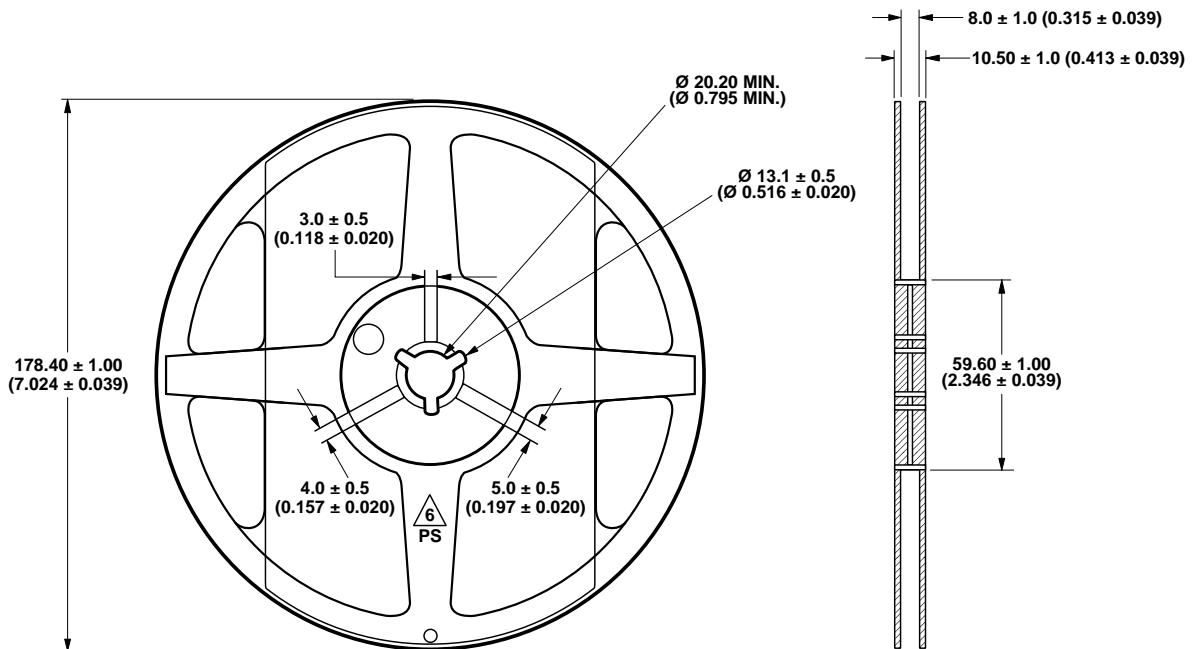

Figure 13. Reel Dimensions.

Note:

1. All dimensions in millimeters (inches).

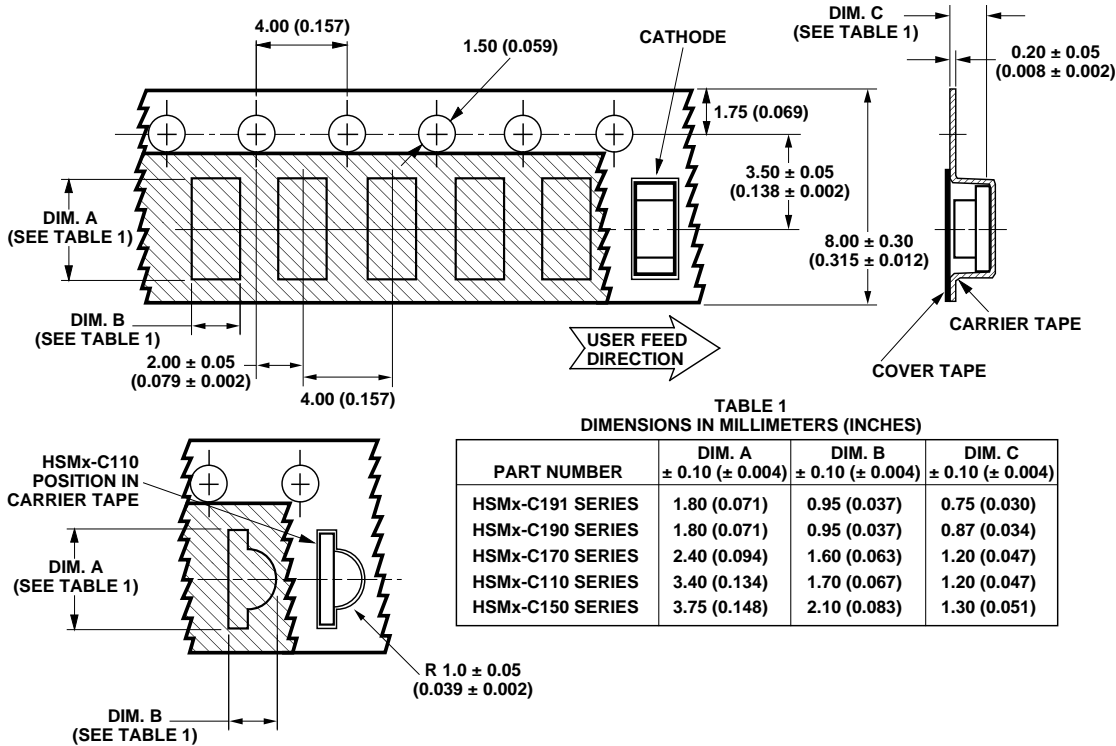

Figure 14. Tape Dimensions.

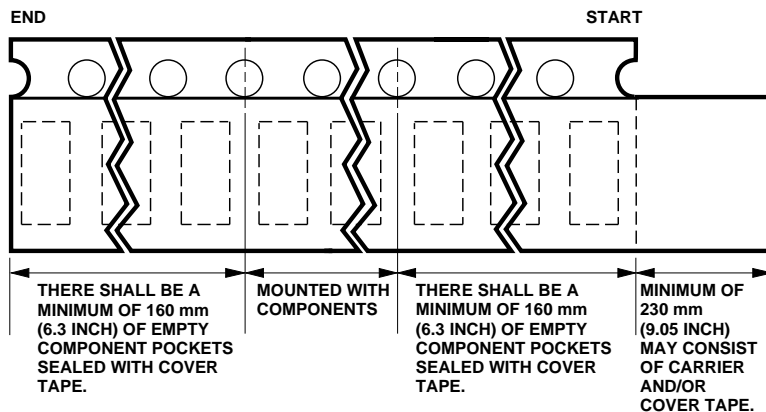

Figure 15. Tape Leader and Trailer Dimensions.

Notes:

1. All dimensions in millimeters (inches).
2. Tolerance is ± 0.1 mm (± 0.004 in.) unless otherwise specified.

Storage Condition: 5 to 30° C @ 60% RH max.

Baking is required under the condition:

- a) the blue silica gel indicator becoming white/transparent color
- b) the pack has been opened for more than 1 week

Baking recommended condition: 60 \pm 5° C for 20 hours.

Convective IR Reflow Soldering

For more information on IR reflow soldering, refer to Application Note 1060, *Surface Mounting SMT LED Indicator Components*.

www.agilent.com/semiconductors

For product information and a complete list of distributors, please go to our web site.

For technical assistance call:

Americas/Canada: +1 (800) 235-0312 or (408) 654-8675

Europe: +49 (0) 6441 92460

China: 10800 650 0017

Hong Kong: (+65) 271 2451

India, Australia, New Zealand: (+65) 271 2394

Japan: (+81 3) 3335-8152(Domestic/International), or 0120-61-1280(Domestic Only)

Korea: (+65) 271 2194

Malaysia, Singapore: (+65) 271 2054

Taiwan: (+65) 271 2654

Data subject to change.

Copyright © 2002 Agilent Technologies, Inc.

Obsoletes 5988-1975EN

February 26, 2002

5988-5211EN



LittleDiode supplies new, hard to find or obsolete electronic components and semiconductors all over the world.

With over two million different components listed you are sure to find the part you need.

Feel free to visit us today at our online store:

LittleDiode.com

Looking forward to providing you with the best possible service.