



Low Noise Micropower Precision Voltage References

ADR290/ADR291/ADR292

FEATURES

Voltage Options 2.048 V, 2.500 V and 4.096 V
2.7 V to 15 V Supply Range
Supply Current 12 μ A max
Initial Accuracy ± 2 mV max
Temperature Coefficient 8 ppm/ $^{\circ}$ C max
Low-Noise 6 μ V p-p (0.1 Hz–10 Hz)
High Output Current 5 mA min
Temperature Range -40° C to $+125^{\circ}$ C
REF02/REF19x Pinout

APPLICATIONS

Portable Instrumentation
Precision Reference for 3 V and 5 V Systems
A/D and D/A Converter Reference
Solar Powered Applications
Loop-Current Powered Instruments

GENERAL DESCRIPTION

The ADR290, ADR291 and ADR292 are low noise, micro-power precision voltage references that use an XFET[™] reference circuit. The new XFET architecture offers significant performance improvements over traditional bandgap and Zener-based references. Improvements include: one quarter the voltage noise output of bandgap references operating at the same current, very low and ultralinear temperature drift, low thermal hysteresis and excellent long-term stability.

The ADR29x family are series voltage references providing stable and accurate output voltages from supplies as low as 2.7 V. Output voltage options are 2.048 V, 2.5 V and 4.096 V for the ADR290, ADR291 and ADR292 respectively. Quiescent current is only 12 μ A, making these devices ideal for battery powered instrumentation. Three electrical grades are available offering initial output accuracies of ± 2 mV, ± 3 mV and ± 6 mV max for the ADR290 and ADR291 and ± 3 mV, ± 4 mV and ± 6 mV max for the ADR292. Temperature coefficients for the three grades are 8 ppm/ $^{\circ}$ C, 15 ppm/ $^{\circ}$ C and 25 ppm/ $^{\circ}$ C max, respectively. Line regulation and load regulation are typically 30 ppm/V and 30 ppm/mA, maintaining the reference's overall high performance. For a device with 5.0 V output, refer to the ADR293 data sheet.

The ADR290, ADR291 and ADR292 references are specified over the extended industrial temperature range of -40° C to $+125^{\circ}$ C. Devices are available in the 8-lead SOIC, 8-lead TSSOP and the TO-92 package.

XFET is a trademark of Analog Devices, Inc.

REV. A

Information furnished by Analog Devices is believed to be accurate and reliable. However, no responsibility is assumed by Analog Devices for its use, nor for any infringements of patents or other rights of third parties which may result from its use. No license is granted by implication or otherwise under any patent or patent rights of Analog Devices.

PIN CONFIGURATIONS

8-Lead Narrow Body SO (R Suffix)

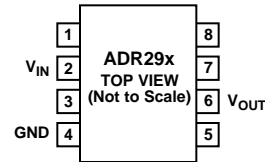

8-Lead TSSOP (RU Suffix)

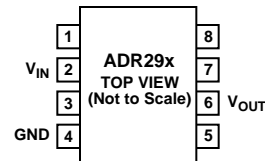

3-Pin TO-92 (T9 Suffix)

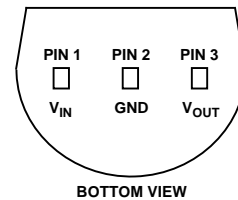

Part Number	Nominal Output Voltage (V)
ADR290	2.048
ADR291	2.500
ADR292	4.096

ADR290/ADR291/ADR292

ADR290—SPECIFICATIONS

Electrical Specifications ($V_S = +2.7\text{ V}$, $T_A = +25^\circ\text{C}$ unless otherwise noted)

Parameter	Symbol	Conditions	Min	Typ	Max	Units
INITIAL ACCURACY “E” Grade “F” Grade “G” Grade	V_O	$I_{OUT} = 0\text{ mA}$	2.046 2.045 2.042	2.048	2.050 2.051 2.054	V V V
LINE REGULATION “E/F” Grades “G” Grade	$\Delta V_O/\Delta V_{IN}$	2.7 V to 15 V, $I_{OUT} = 0\text{ mA}$		30 40	100 125	ppm/V ppm/V
LOAD REGULATION “E/F” Grades “G” Grade	$\Delta V_O/\Delta I_{LOAD}$	$V_S = 5.0\text{ V}$, 0 mA to 5 mA		30 40	100 125	ppm/mA ppm/mA
LONG TERM STABILITY	ΔV_O	1000 hrs @ $+25^\circ\text{C}$, $V_S = +15\text{ V}$		0.2		ppm
NOISE VOLTAGE	e_N	0.1 Hz to 10 Hz		6		$\mu\text{V p-p}$
WIDEBAND NOISE DENSITY	e_n	at 1 kHz		420		$\text{nV}/\sqrt{\text{Hz}}$

Electrical Specifications ($V_S = +2.7\text{ V}$, $T_A = -25^\circ\text{C} \leq T_A \leq +85^\circ\text{C}$ unless otherwise noted)

Parameter	Symbol	Conditions	Min	Typ	Max	Units
TEMPERATURE COEFFICIENT “E” Grade “F” Grade “G” Grade	$\text{TCV}_O/^\circ\text{C}$	$I_{OUT} = 0\text{ mA}$		3 6 10	8 15 25	ppm/ $^\circ\text{C}$ ppm/ $^\circ\text{C}$ ppm/ $^\circ\text{C}$
LINE REGULATION “E/F” Grades “G” Grade	$\Delta V_O/\Delta V_{IN}$	2.7 V to 15 V, $I_{OUT} = 0\text{ mA}$		35 50	125 150	ppm/V ppm/V
LOAD REGULATION “E/F” Grades “G” Grade	$\Delta V_O/\Delta I_{LOAD}$	$V_S = 5.0\text{ V}$, 0 mA to 5 mA		20 30	125 150	ppm/mA ppm/mA

Electrical Specifications ($V_S = +2.7\text{ V}$, $T_A = -40^\circ\text{C} \leq T_A \leq +125^\circ\text{C}$ unless otherwise noted)

Parameter	Symbol	Conditions	Min	Typ	Max	Units
TEMPERATURE COEFFICIENT “E” Grade “F” Grade “G” Grade	$\text{TCV}_O/^\circ\text{C}$	$I_{OUT} = 0\text{ mA}$		3 5 10	10 20 30	ppm/ $^\circ\text{C}$ ppm/ $^\circ\text{C}$ ppm/ $^\circ\text{C}$
LINE REGULATION “E/F” Grades “G” Grade	$\Delta V_O/\Delta V_{IN}$	2.7 V to 15 V, $I_{OUT} = 0\text{ mA}$		40 70	200 250	ppm/V ppm/V
LOAD REGULATION “E/F” Grades “G” Grade	$\Delta V_O/\Delta I_{LOAD}$	$V_S = 5.0\text{ V}$, 0 mA to 5 mA		20 30	200 300	ppm/mA ppm/mA
SUPPLY CURRENT		@ $+25^\circ\text{C}$		8 12	12 15	μA μA
THERMAL HYSTERESIS		TO-92, SO-8, TSSOP-8		50		ppm

NOTE
Specifications subject to change without notice.

ADR291—SPECIFICATIONS

ADR290/ADR291/ADR292

Electrical Specifications ($V_S = +3.0\text{ V}$, $T_A = +25^\circ\text{C}$ unless otherwise noted)

Parameter	Symbol	Conditions	Min	Typ	Max	Units
INITIAL ACCURACY “E” Grade “F” Grade “G” Grade	V_O	$I_{OUT} = 0\text{ mA}$	2.498 2.497 2.494	2.500	2.502 2.503 2.506	V V V
LINE REGULATION “E/F” Grades “G” Grade	$\Delta V_O/\Delta V_{IN}$	3.0 V to 15 V, $I_{OUT} = 0\text{ mA}$		30 40	100 125	ppm/V ppm/V
LOAD REGULATION “E/F” Grades “G” Grade	$\Delta V_O/\Delta I_{LOAD}$	$V_S = 5.0\text{ V}$, 0 mA to 5 mA		30 40	100 125	ppm/mA ppm/mA
LONG TERM STABILITY	ΔV_O	1000 hrs @ $+25^\circ\text{C}$, $V_S = +15\text{ V}$		0.2		ppm
NOISE VOLTAGE	e_N	0.1 Hz to 10 Hz		8		$\mu\text{V p-p}$
WIDEBAND NOISE DENSITY	e_n	at 1 kHz		480		$\text{nV}/\sqrt{\text{Hz}}$

Electrical Specifications ($V_S = +3.0\text{ V}$, $T_A = -25^\circ\text{C} \leq T_A \leq +85^\circ\text{C}$ unless otherwise noted)

Parameter	Symbol	Conditions	Min	Typ	Max	Units
TEMPERATURE COEFFICIENT “E” Grade “F” Grade “G” Grade	$\text{TCV}_O/^\circ\text{C}$	$I_{OUT} = 0\text{ mA}$		3 5 10	8 15 25	ppm/ $^\circ\text{C}$ ppm/ $^\circ\text{C}$ ppm/ $^\circ\text{C}$
LINE REGULATION “E/F” Grades “G” Grade	$\Delta V_O/\Delta V_{IN}$	3.0 V to 15 V, $I_{OUT} = 0\text{ mA}$		35 50	125 150	ppm/V ppm/V
LOAD REGULATION “E/F” Grades “G” Grade	$\Delta V_O/\Delta I_{LOAD}$	$V_S = 5.0\text{ V}$, 0 mA to 5 mA		20 30	125 150	ppm/mA ppm/mA

Electrical Specifications ($V_S = +3.0\text{ V}$, $T_A = -40^\circ\text{C} \leq T_A \leq +125^\circ\text{C}$ unless otherwise noted)

Parameter	Symbol	Conditions	Min	Typ	Max	Units
TEMPERATURE COEFFICIENT “E” Grade “F” Grade “G” Grade	$\text{TCV}_O/^\circ\text{C}$	$I_{OUT} = 0\text{ mA}$		3 5 10	10 20 30	ppm/ $^\circ\text{C}$ ppm/ $^\circ\text{C}$ ppm/ $^\circ\text{C}$
LINE REGULATION “E/F” Grades “G” Grade	$\Delta V_O/\Delta V_{IN}$	3.0 V to 15 V, $I_{OUT} = 0\text{ mA}$		40 70	200 250	ppm/V ppm/V
LOAD REGULATION “E/F” Grades “G” Grade	$\Delta V_O/\Delta I_{LOAD}$	$V_S = 5.0\text{ V}$, 0 mA to 5 mA		20 30	200 300	ppm/mA ppm/mA
SUPPLY CURRENT		@ $+25^\circ\text{C}$		9 12	12 15	μA μA
THERMAL HYSTERESIS		TO-92, SO-8, TSSOP-8		50		ppm

NOTE

Specifications subject to change without notice.

ADR290/ADR291/ADR292

ADR292—SPECIFICATIONS

Electrical Specifications ($V_S = +5\text{ V}$, $T_A = +25^\circ\text{C}$ unless otherwise noted)

Parameter	Symbol	Conditions	Min	Typ	Max	Units
INITIAL ACCURACY “E” Grade “F” Grade “G” Grade	V_O	$I_{OUT} = 0\text{ mA}$	4.093 4.092 4.090	4.096	4.099 4.100 4.102	V V V
LINE REGULATION “E/F” Grades “G” Grade	$\Delta V_O/\Delta V_{IN}$	4.5 V to 15 V, $I_{OUT} = 0\text{ mA}$		30 40	100 125	ppm/V ppm/V
LOAD REGULATION “E/F” Grades “G” Grade	$\Delta V_O/\Delta I_{LOAD}$	$V_S = 5.0\text{ V}$, 0 mA to 5 mA		30 40	100 125	ppm/mA ppm/mA
LONG TERM STABILITY	ΔV_O	1000 hrs @ $+25^\circ\text{C}$, $V_S = +15\text{ V}$		0.2		ppm
NOISE VOLTAGE	e_N	0.1 Hz to 10 Hz		12		$\mu\text{V p-p}$
WIDEBAND NOISE DENSITY	e_N	at 1 kHz		640		$\text{nV}/\sqrt{\text{Hz}}$

Electrical Specifications ($V_S = +5\text{ V}$, $T_A = -25^\circ\text{C} \leq T_A \leq +85^\circ\text{C}$ unless otherwise noted)

Parameter	Symbol	Conditions	Min	Typ	Max	Units
TEMPERATURE COEFFICIENT “E” Grade “F” Grade “G” Grade	$\text{TCV}_O/^\circ\text{C}$	$I_{OUT} = 0\text{ mA}$		3 5 10	8 15 25	ppm/ $^\circ\text{C}$ ppm/ $^\circ\text{C}$ ppm/ $^\circ\text{C}$
LINE REGULATION “E/F” Grades “G” Grade	$\Delta V_O/\Delta V_{IN}$	4.5 V to 15 V, $I_{OUT} = 0\text{ mA}$		35 50	125 150	ppm/V ppm/V
LOAD REGULATION “E/F” Grades “G” Grade	$\Delta V_O/\Delta I_{LOAD}$	$V_S = 5.0\text{ V}$, 0 mA to 5 mA		20 30	125 150	ppm/mA ppm/mA

Electrical Specifications ($V_S = +5\text{ V}$, $T_A = -40^\circ\text{C} \leq T_A \leq +125^\circ\text{C}$ unless otherwise noted)

Parameter	Symbol	Conditions	Min	Typ	Max	Units
TEMPERATURE COEFFICIENT “E” Grade “F” Grade “G” Grade	$\text{TCV}_O/^\circ\text{C}$	$I_{OUT} = 0\text{ mA}$		3 5 10	10 20 30	ppm/ $^\circ\text{C}$ ppm/ $^\circ\text{C}$ ppm/ $^\circ\text{C}$
LINE REGULATION “E/F” Grades “G” Grade	$\Delta V_O/\Delta V_{IN}$	4.5 V to 15 V, $I_{OUT} = 0\text{ mA}$		40 70	200 250	ppm/V ppm/V
LOAD REGULATION “E/F” Grades “G” Grade	$\Delta V_O/\Delta I_{LOAD}$	$V_S = 5.0\text{ V}$, 0 mA to 5 mA		20 30	200 300	ppm/mA ppm/mA
SUPPLY CURRENT		@ $+25^\circ\text{C}$		10 12	15 18	μA μA
THERMAL HYSTERESIS		TO-92, SO-8, TSSOP-8		50		ppm

NOTE
Specifications subject to change without notice.

WAFER TEST LIMITS (@ $I_{LOAD} = 0 \text{ mA}$, $T_A = +25^\circ\text{C}$ unless otherwise noted)

Parameter	Symbol	Conditions	Limits	Units
INITIAL ACCURACY				
ADR290	V_O		2.042/2.054	V
ADR291	V_O		2.494/2.506	V
ADR292	V_O		4.090/4.102	V
LINE REGULATION	$\Delta V_O/\Delta V_{IN}$	$V_O + 1 \text{ V} < V_{IN} < 15 \text{ V}$, $I_{OUT} = 0 \text{ mA}$	125	ppm/V
LOAD REGULATION	$\Delta V_O/\Delta I_{LOAD}$	0 to 5 mA, $V_{IN} = V_O + 1 \text{ V}$	125	ppm/mA
SUPPLY CURRENT		ADR290, ADR291, No Load	12	μA
		ADR292, No Load	15	μA

NOTES

Electrical tests are performed as wafer probe to the limits shown. Due to variations in assembly methods and normal yield loss, yield after packaging is not guaranteed for standard product dice. Consult factory to negotiate specifications based on dice lot qualification through sample lot assembly and testing. Specifications subject to change without notice.

DICE CHARACTERISTICS

Die Size 0.074 × 0.052 inch, 3848 sq. mils
 (1.88 × 1.32 mm, 2.48 sq. mm)
 Transistor Count: 52

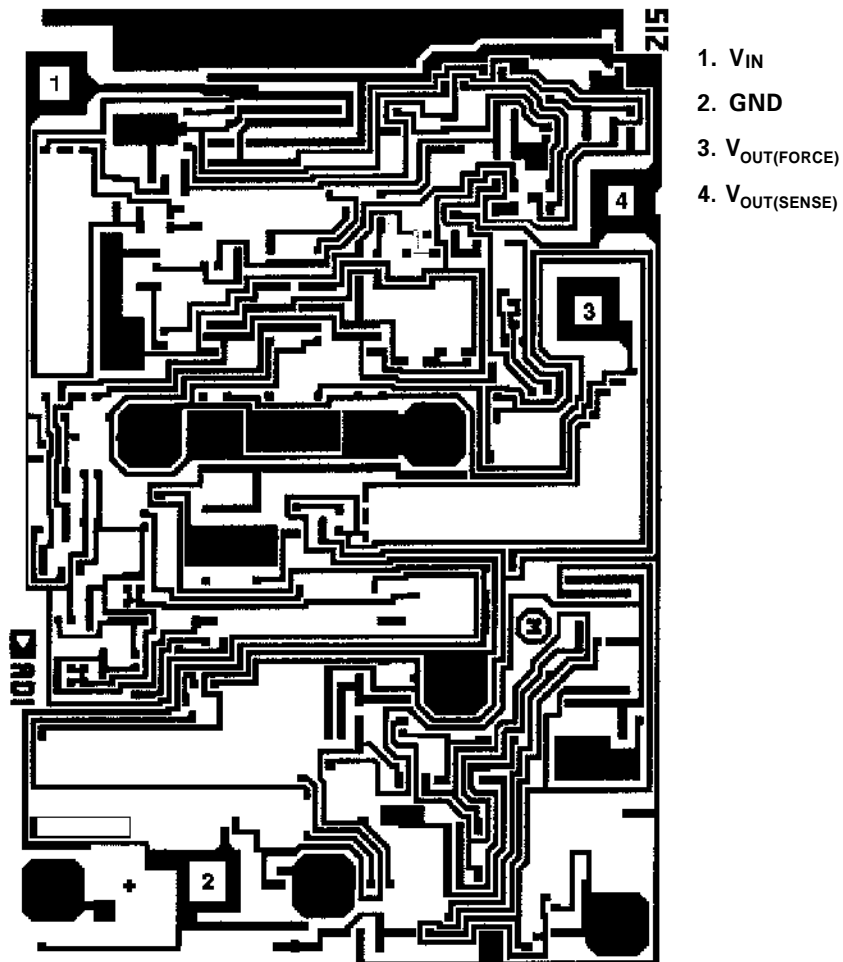

For additional DICE ordering information, refer to databook.

ADR290/ADR291/ADR292

ABSOLUTE MAXIMUM RATINGS*

Supply Voltage	+18 V
Output Short-Circuit Duration	Indefinite
Storage Temperature Range	
T9, R, RU Package	-65°C to +150°C
Operating Temperature Range	
ADR290/ADR291/ADR292	-40°C to +125°C
Junction Temperature Range	
T9, R, RU Package	-65°C to +125°C
Lead Temperature (Soldering, 60 sec)	+300°C

Package Type	θ_{JA}^1	θ_{JC}	Units
8-Lead SOIC (R)	158	43	°C/W
8-Lead TO-92 (T9)	162	120	°C/W
3-Pin TSSOP (RU)	240	43	°C/W

NOTE

¹ θ_{JA} is specified for worst case conditions, i.e. θ_{JA} is specified for device in socket for PDIP, and θ_{JA} is specified for a device soldered in circuit board for SOIC packages.

*CAUTION

1. Stresses above those listed under Absolute Maximum Ratings may cause permanent damage to the device. This is a stress rating only; functional operation at or above this specification is not implied. Exposure to the above maximum rating conditions for extended periods may affect device reliability.
2. Remove power before inserting or removing units from their sockets.
3. Ratings apply to both DICE and packaged parts, unless otherwise noted

ORDERING GUIDE

Model	Temperature Range	Package
ADR290ER, ADR290FR, ADR290GR ADR290ER-REEL, ADR290FR-REEL, ADR290GR-REEL ADR290ER-REEL7, ADR290FR-REEL7, ADR290GR-REEL7 ADR290GT9 ADR290GT9-REEL ADR290GRU-REEL ADR290GRU-REEL7 ADR290GBC	-40°C to +125°C -40°C to +125°C -40°C to +125°C -40°C to +125°C -40°C to +125°C -40°C to +125°C -40°C to +125°C -40°C to +125°C +25°C	8-Lead SOIC 8-Lead SOIC 8-Lead SOIC 3-Pin TO-92 3-Pin TO-92 8-Lead TSSOP 8-Lead TSSOP DICE
ADR291ER, ADR291FR, ADR291GR ADR291ER-REEL, ADR291FR-REEL, ADR291GR-REEL ADR291ER-REEL7, ADR291FR-REEL7, ADR291GR-REEL7 ADR291GT9 ADR291GT9-REEL ADR291GRU-REEL ADR291GRU-REEL7 ADR291GBC	-40°C to +125°C -40°C to +125°C -40°C to +125°C -40°C to +125°C -40°C to +125°C -40°C to +125°C -40°C to +125°C -40°C to +125°C +25°C	8-Lead SOIC 8-Lead SOIC 8-Lead SOIC 3-Pin TO-92 3-Pin TO-92 8-Lead TSSOP 8-Lead TSSOP DICE
ADR292ER, ADR292FR, ADR292GR ADR292ER-REEL, ADR292FR-REEL, ADR292GR-REEL ADR292ER-REEL7, ADR292FR-REEL7, ADR292GR-REEL7 ADR292GT9 ADR292GT9-REEL ADR292GRU-REEL ADR292GRU-REEL7 ADR292GBC	-40°C to +125°C -40°C to +125°C -40°C to +125°C -40°C to +125°C -40°C to +125°C -40°C to +125°C -40°C to +125°C -40°C to +125°C +25°C	8-Lead SOIC 8-Lead SOIC 8-Lead SOIC 3-Pin TO-92 3-Pin TO-92 8-Lead TSSOP 8-Lead TSSOP DICE

CAUTION

ESD (electrostatic discharge) sensitive device. Electrostatic charges as high as 4000 V readily accumulate on the human body and test equipment and can discharge without detection. Although the ADR290/ADR291/ADR292 features proprietary ESD protection circuitry, permanent damage may occur on devices subjected to high energy electrostatic discharges. Therefore, proper ESD precautions are recommended to avoid performance degradation or loss of functionality.



ADR290/ADR291/ADR292

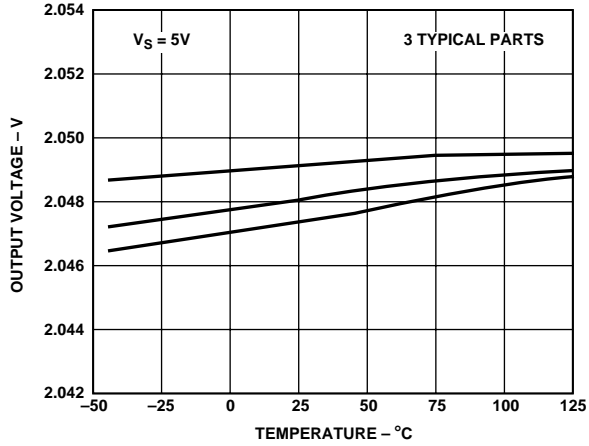

Figure 1. ADR290 V_{OUT} vs. Temperature

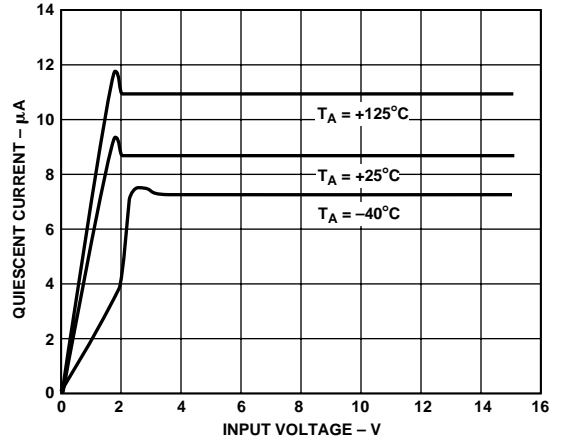

Figure 4. ADR290 Quiescent Current vs. Input Voltage

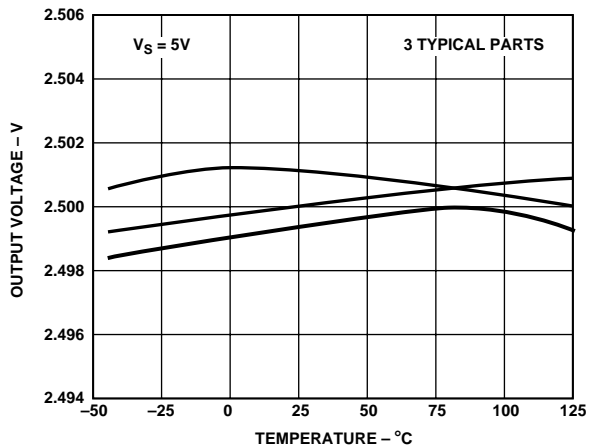

Figure 2. ADR291 V_{OUT} vs. Temperature

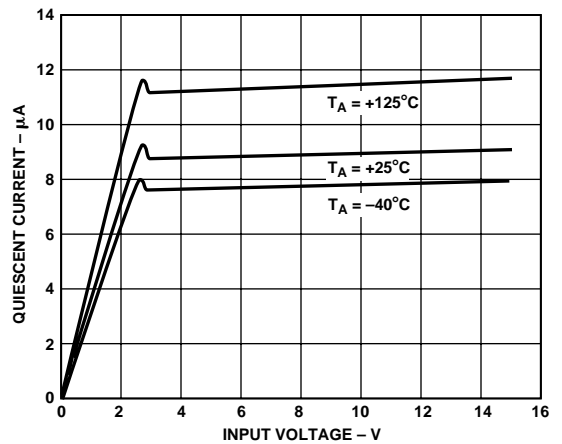

Figure 5. ADR291 Quiescent Current vs. Input Voltage

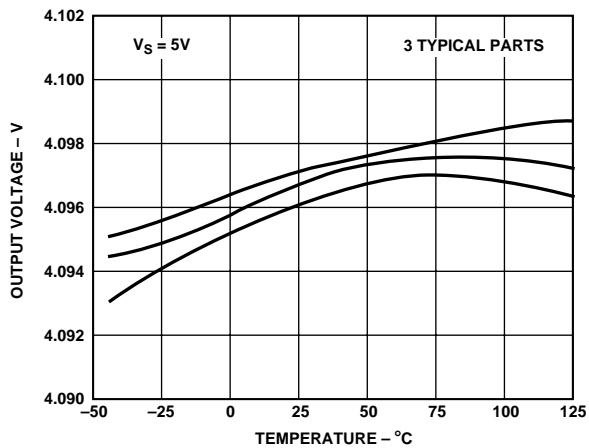

Figure 3. ADR292 V_{OUT} vs. Temperature

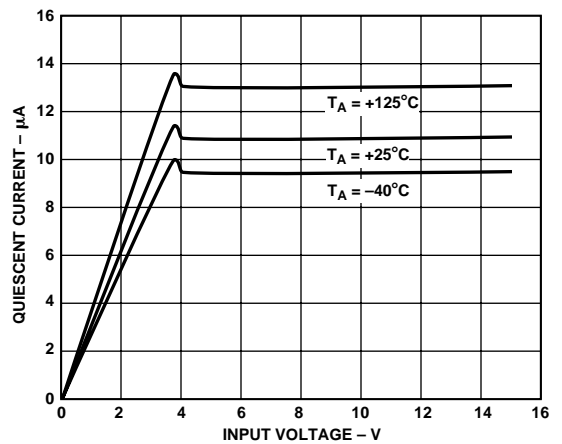

Figure 6. ADR292 Quiescent Current vs. Input Voltage

ADR290/ADR291/ADR292

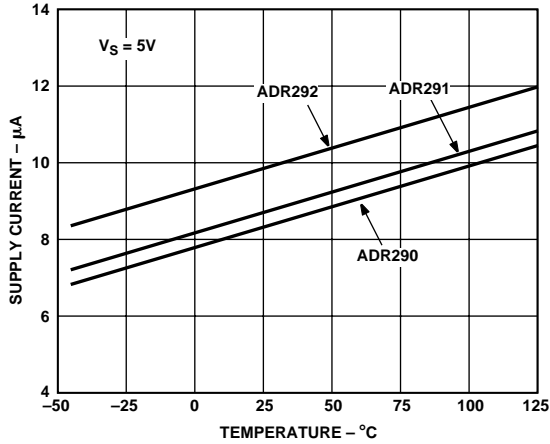

Figure 7. ADR290/ADR291/ADR292 Supply Current vs. Temperature

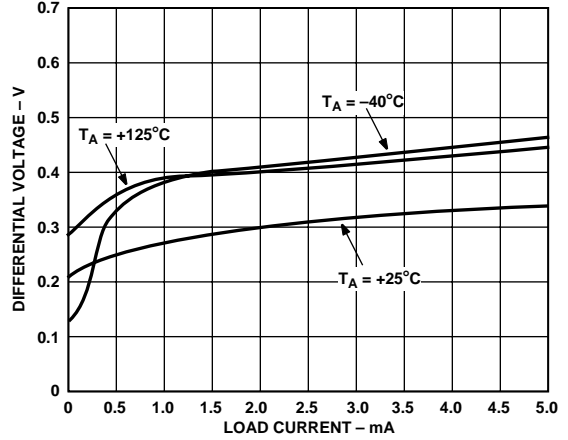

Figure 10. ADR290 Minimum Input-Output Voltage Differential vs. Load Current

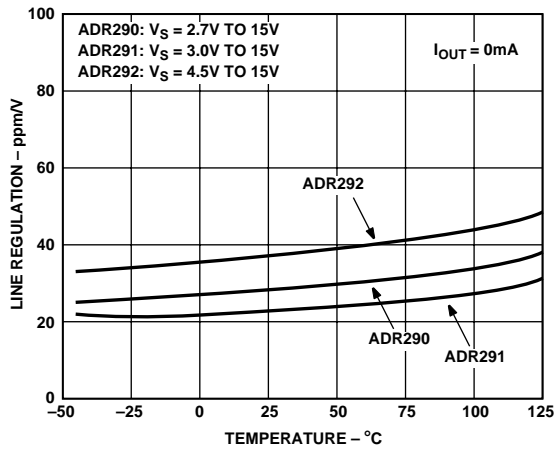

Figure 8. ADR290/ADR291/ADR292 Line Regulation vs. Temperature

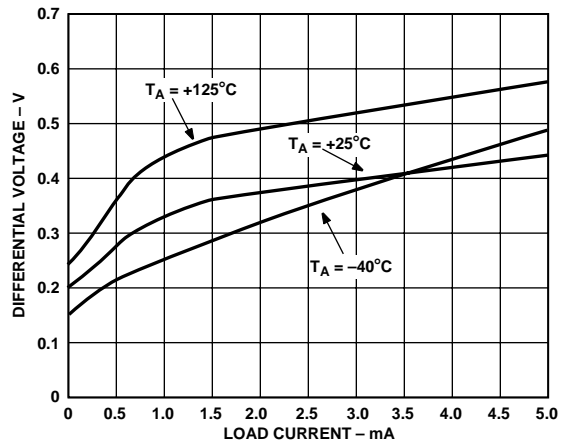

Figure 11. ADR291 Minimum Input-Output Voltage Differential vs. Load Current

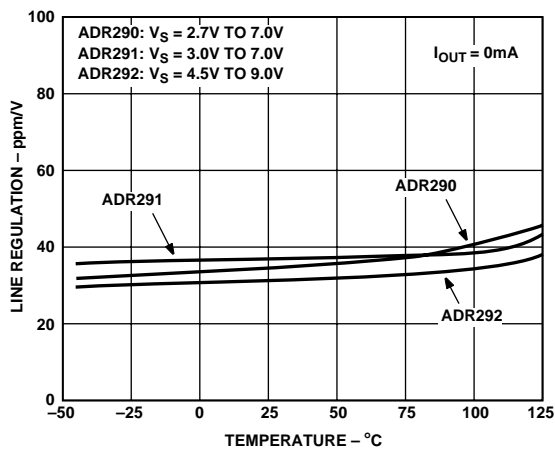

Figure 9. ADR290/ADR291/ADR292 Line Regulation vs. Temperature

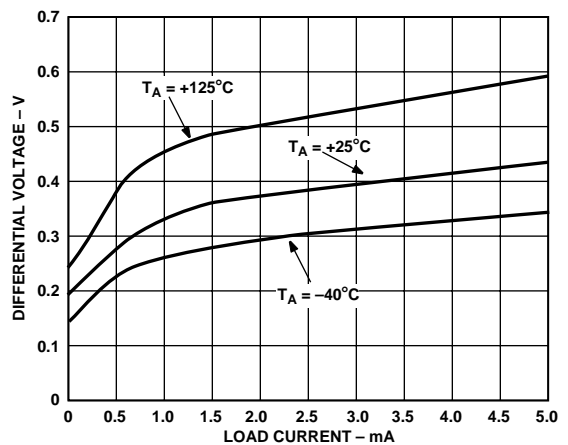

Figure 12. ADR292 Minimum Input-Output Voltage Differential vs. Load Current

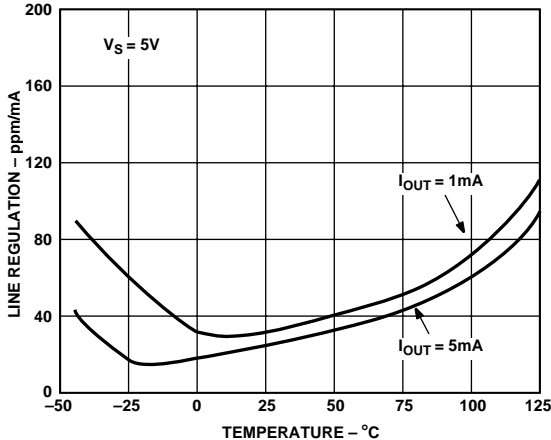

Figure 13. ADR290 Line Regulation vs. Temperature

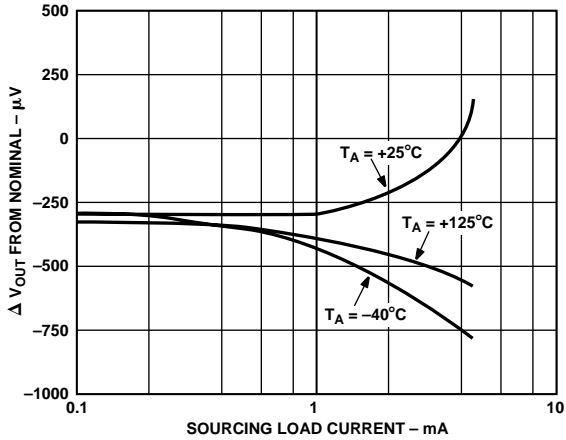

Figure 16. ADR290 ΔV_{OUT} from Nominal vs. Load Current

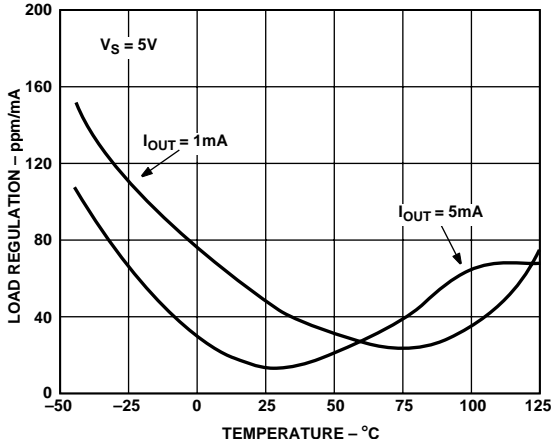

Figure 14. ADR291 Load Regulation vs. Temperature

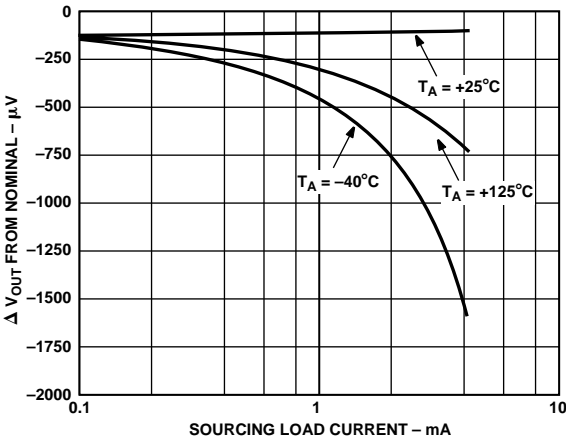

Figure 17. ADR291 ΔV_{OUT} from Nominal vs. Load Current

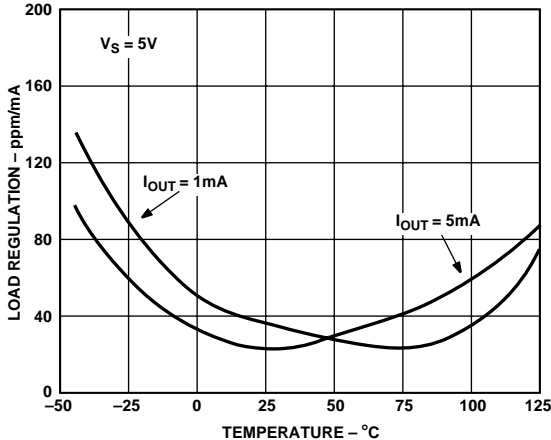

Figure 15. ADR292 Load Regulation vs. Temperature

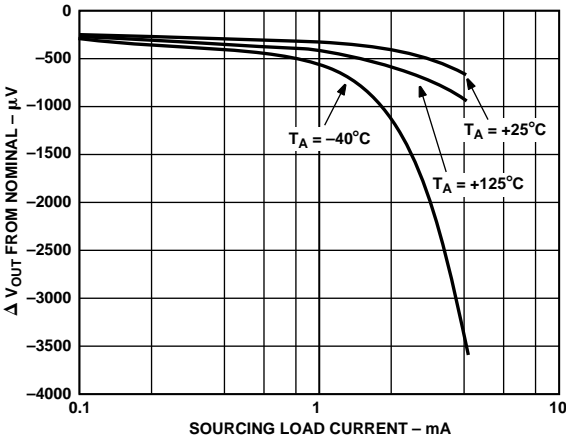

Figure 18. ADR292 ΔV_{OUT} from Nominal vs. Load Current

ADR290/ADR291/ADR292

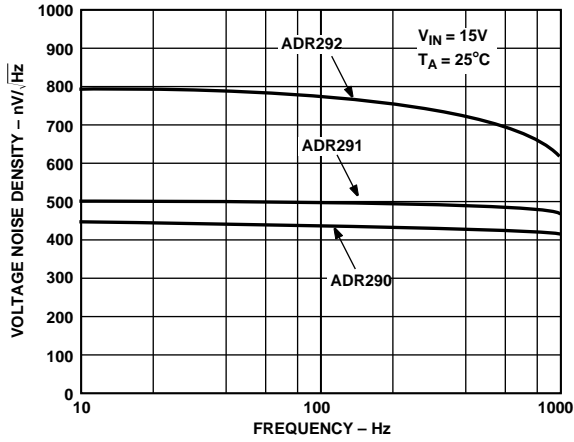

Figure 19. Voltage Noise Density vs. Frequency

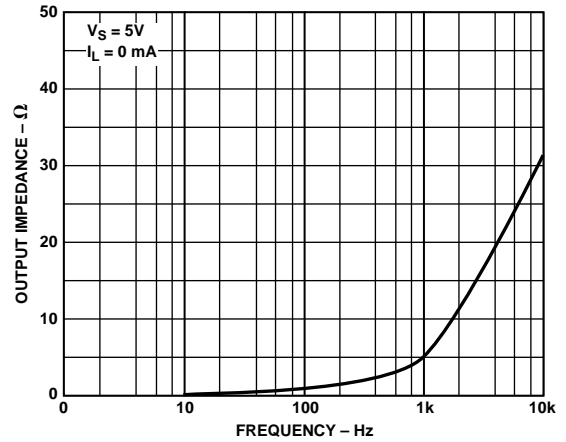

Figure 22. ADR290 Output Impedance vs. Frequency

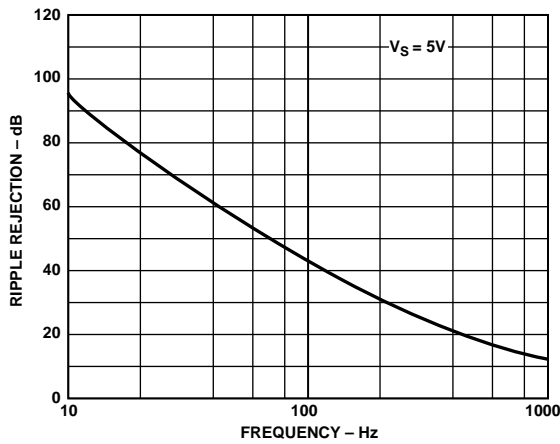

Figure 20. ADR290/ADR291/ADR292 Ripple Rejection vs. Frequency

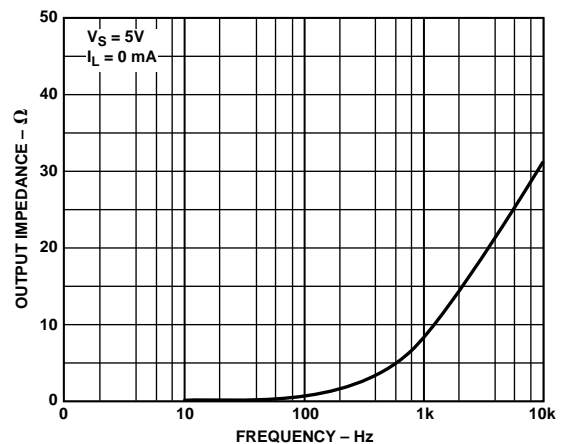

Figure 23. ADR291 Output Impedance vs. Frequency

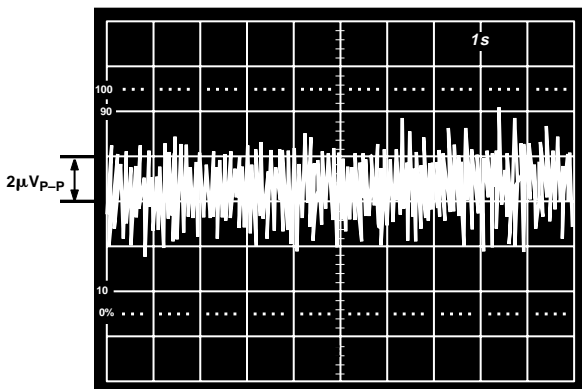

Figure 21. ADR290 0.1 Hz to 10 Hz Noise

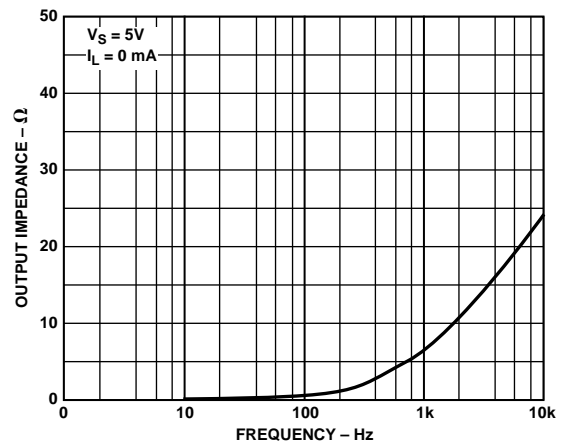

Figure 24. ADR292 Output Impedance vs. Frequency

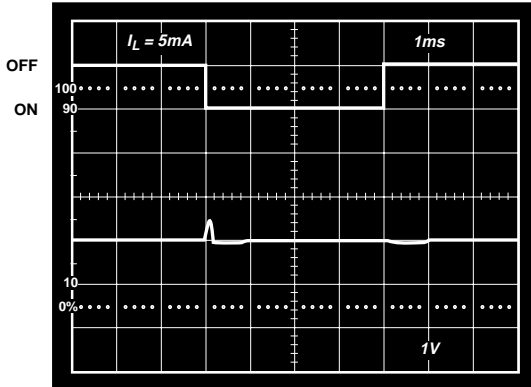

Figure 25. ADR291 Load Transient

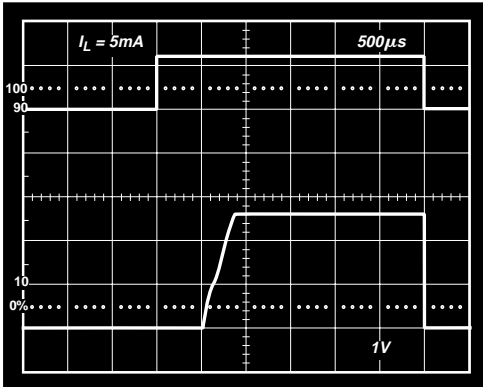

Figure 28. ADR291 Turn-On Time

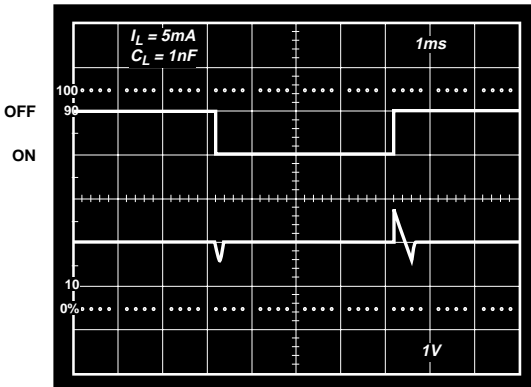

Figure 26. ADR291 Load Transient

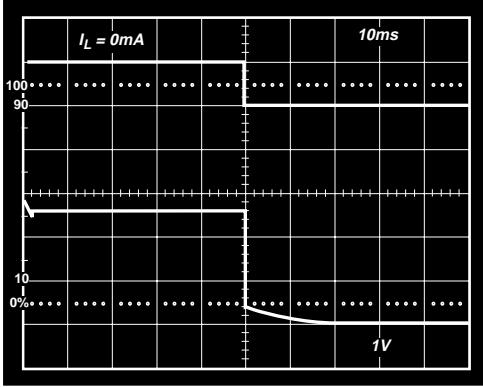

Figure 29. ADR291 Turn-Off Time

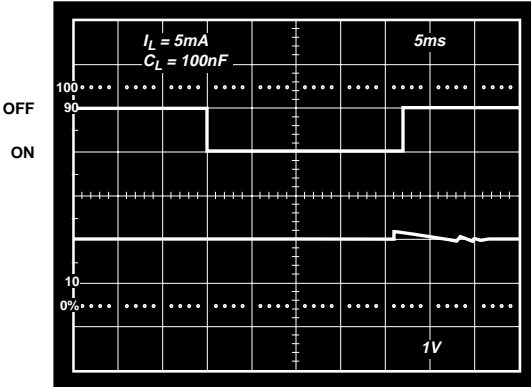

Figure 27. ADR291 Load Transient

ADR290/ADR291/ADR292

THEORY OF OPERATION

The ADR29x series of references uses a new reference generation technique known as XFET (eXtra implanted junction FET). This technique yields a reference with low noise, low supply current and very low thermal hysteresis.

The core of the XFET reference consists of two junction field-effect transistors, one of which has an extra channel implant to raise its pinch-off voltage. By running the two JFETs at the same drain current, the difference in pinch-off voltage can be amplified and used to form a highly stable voltage reference. The intrinsic reference voltage is around 0.5 V with a negative temperature coefficient of about -120 ppm/K. This slope is essentially locked to the dielectric constant of silicon and can be closely compensated by adding a correction term generated in the same fashion as the proportional-to-temperature (PTAT) term used to compensate bandgap references. The big advantage over a bandgap reference is that the intrinsic temperature coefficient is some thirty times lower (therefore less correction is needed) and this results in much lower noise since most of the noise of a bandgap reference comes from the temperature compensation circuitry.

The simplified schematic below shows the basic topology of the ADR29x series. The temperature correction term is provided by a current source with value designed to be proportional to absolute temperature. The general equation is:

$$V_{OUT} = \Delta V_P \left(\frac{R1 + R2 + R3}{R1} \right) + (I_{PTAT})(R3)$$

where ΔV_P is the difference in pinch-off voltage between the two FETs, and I_{PTAT} is the positive temperature coefficient correction current. The various versions of the ADR29x family are created by on-chip adjustment of R1 and R3 to achieve 2.048 V, 2.500 V or 4.096 V at the reference output.

The process used for the XFET reference also features vertical NPN and PNP transistors, the latter of which are used as output devices to provide a very low drop-out voltage.

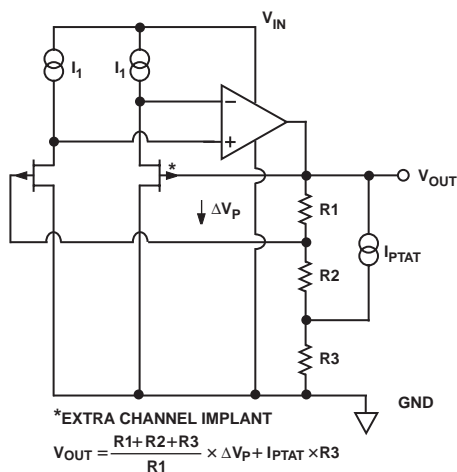

Figure 30. ADR290/ADR291/ADR292 Simplified Schematic

Device Power Dissipation Considerations

The ADR29x family of references is guaranteed to deliver load currents to 5 mA with an input voltage that ranges from 2.7 V to 15 V (minimum supply voltage depends on output voltage option). When these devices are used in applications with large input voltages, care should be exercised to avoid exceeding the published specifications for maximum power dissipation or junction temperature that could result in premature device failure. The following formula should be used to calculate a device's maximum junction temperature or dissipation:

$$P_D = \frac{T_J - T_A}{\theta_{JA}}$$

In this equation, T_J and T_A are the junction and ambient temperatures, respectively, P_D is the device power dissipation, and θ_{JA} is the device package thermal resistance.

Basic Voltage Reference Connections

References, in general, require a bypass capacitor connected from the V_{OUT} pin to the GND pin. The circuit in Figure 31 illustrates the basic configuration for the ADR29x family of references. Note that the decoupling capacitors are not required for circuit stability.

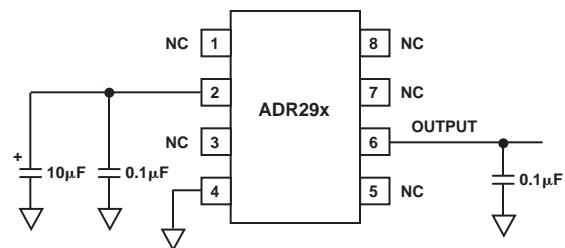

Figure 31. Basic Voltage Reference Configuration

Noise Performance

The noise generated by the ADR29x family of references is typically less than 12 μV p-p over the 0.1 Hz to 10 Hz band. Figure 21 shows the 0.1 Hz to 10 Hz noise of the ADR290 which is only 6 μV p-p. The noise measurement is made with a bandpass filter made of a 2-pole high-pass filter with a corner frequency at 0.1 Hz and a 2-pole low-pass filter with a corner frequency at 10 Hz.

Turn-On Time

Upon application of power (cold start), the time required for the output voltage to reach its final value within a specified error band is defined as the turn-on settling time. Two components normally associated with this are the time for the active circuits to settle, and the time for the thermal gradients on the chip to stabilize. Figure 28 shows the turn-on settling time for the ADR291.

APPLICATIONS SECTION

A Negative Precision Reference without Precision Resistors

In many current-output CMOS DAC applications, where the output signal voltage must be of the same polarity as the reference voltage, it is often required to reconfigure a current-switching DAC into a voltage-switching DAC through the use of a 1.25 V reference, an op amp and a pair of resistors. Using a current-switching DAC directly requires the need for an additional operational amplifier at the output to reinvert the signal. A negative voltage reference is then desirable from the point that

an additional operational amplifier is not required for either reinversion (current-switching mode) or amplification (voltage-switching mode) of the DAC output voltage. In general, any positive voltage reference can be converted into a negative voltage reference through the use of an operational amplifier and a pair of matched resistors in an inverting configuration. The disadvantage to that approach is that the largest single source of error in the circuit is the relative matching of the resistors used.

The circuit illustrated in Figure 32 avoids the need for tightly matched resistors with the use of an active integrator circuit. In this circuit, the output of the voltage reference provides the input drive for the integrator. The integrator, to maintain circuit equilibrium adjusts its output to establish the proper relationship between the reference's V_{OUT} and GND. Thus, any negative output voltage desired can be chosen by simply substituting for the appropriate reference IC. One caveat with this approach should be mentioned: although rail-to-rail output amplifiers work best in the application, these operational amplifiers require a finite amount (mV) of headroom when required to provide any load current. The choice for the circuit's negative supply should take this issue into account.

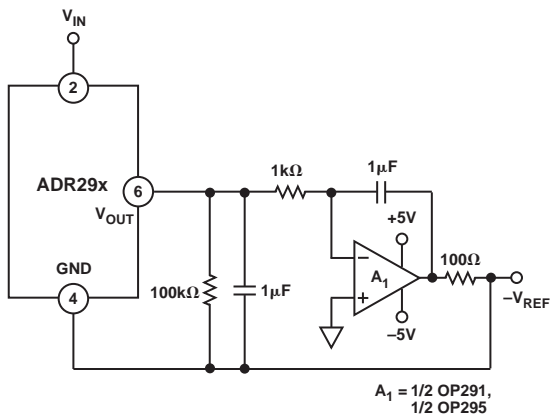

Figure 32. A Negative Precision Voltage Reference Uses No Precision Resistors

A Precision Current Source

Many times in low power applications, the need arises for a precision current source that can operate on low supply voltages. As shown in Figure 33, any one of the devices in the ADR29x family of references can be configured as a precision current source. The circuit configuration illustrated is a floating current source with a grounded load. The reference's output voltage is bootstrapped across R_{SET} , which sets the output current into the load. With this configuration, circuit precision is maintained for load currents in the range from the reference's supply current, typically 12 μ A to approximately 5 mA.

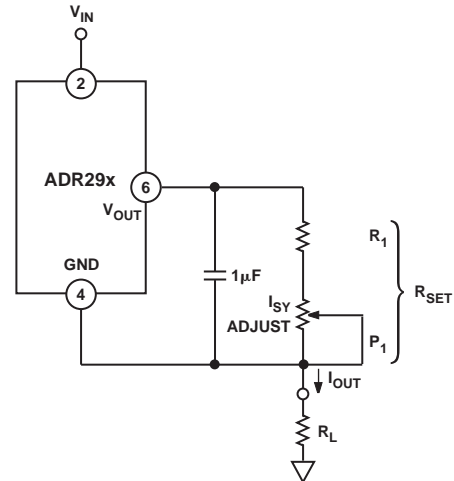

Figure 33. A Precision Current Source

High Voltage Floating Current Source

The circuit of Figure 34 can be used to generate a floating current source with minimal self heating. This particular configuration can operate on high supply voltages determined by the breakdown voltage of the N-channel JFET.

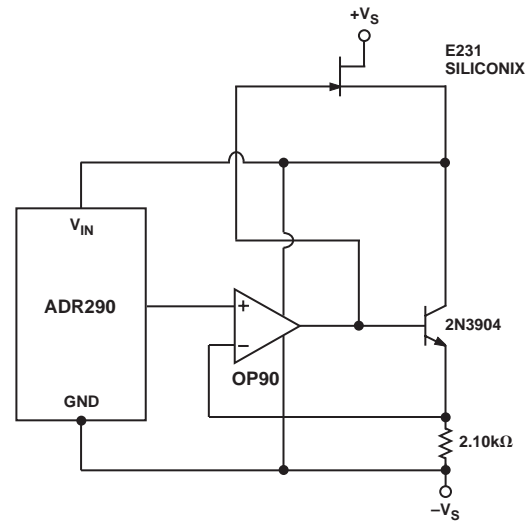

Figure 34. High Voltage Floating Current Source

Kelvin Connections

In many portable instrumentation applications, where PC board cost and area go hand-in-hand, circuit interconnects are very often of dimensionally minimum width. These narrow lines can cause large voltage drops if the voltage reference is required to provide load currents to various functions. In fact, a circuit's interconnects can exhibit a typical line resistance of 0.45 mW/square (1 oz. Cu, for example). Force and sense connections also referred to as Kelvin connections, offer a convenient method of eliminating the effects of voltage drops in circuit wires. Load currents flowing through wiring resistance produce an error ($V_{ERROR} = R \times I_L$) at the load. However, the Kelvin connection of Figure 35, overcomes the problem by including the wiring resistance within the forcing loop of the op amp. Since the op amp senses the load voltage, op amp loop control forces the output to compensate for the wiring error and to produce the correct voltage at the load.

OUTLINE DIMENSIONS

Dimensions shown in inches and (mm).

8-Lead Narrow Body SO (R Suffix)

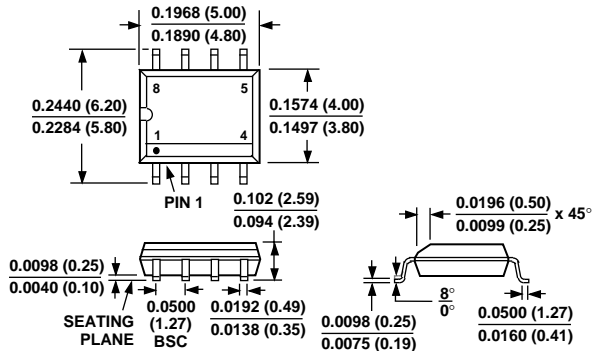

8-Lead TSSOP (RU Suffix)

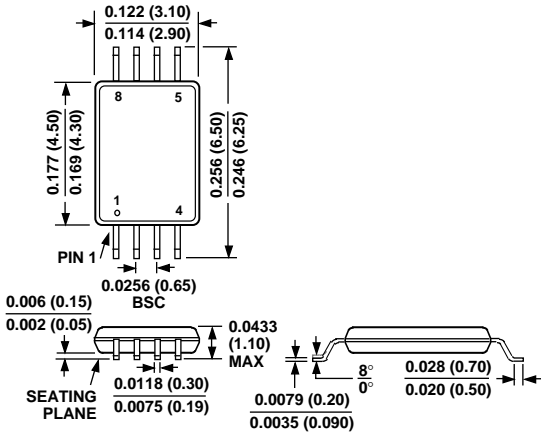

3-Pin TO-92 (T9 Suffix)

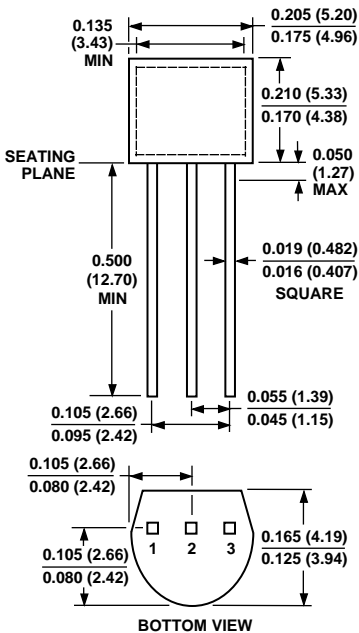

C3151-0-2/00 (rev. A)

PRINTED IN U.S.A.



LittleDiode supplies new, hard to find or obsolete electronic components and semiconductors all over the world.

With over two million different components listed you are sure to find the part you need.

Feel free to visit us today at our online store:

LittleDiode.com

Looking forward to providing you with the best possible service.