



## ACST4 Series

### ASD™ AC Switch Family

### AC POWER SWITCH

#### MAIN APPLICATIONS

- AC static switching in appliance control systems
- Drive of low power high inductive or resistive loads like
  - spray pump in dishwashers
  - fan in air-conditioners

#### FEATURES

- Blocking voltage :  $V_{DRM} / V_{RRM} = +/-700V$
- Avalanche controlled :  $V_{CL\ typ} = 1100\ V$
- Nominal conducting current :  $I_{T(RMS)} = 4A$
- High surge current capability: 30A for 20ms full wave
- Gate triggering current :  $I_{GT} < 10\ mA$  or 25mA
- Switch integrated driver
- High noise immunity : static  $dV/dt > 500V/\mu s$

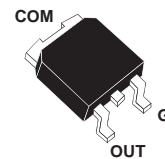
#### BENEFITS

- Enables equipment to meet IEC 61000-4-5
- High off-state reliability with planar technology
- No external overvoltage protection needed
- Reduces the power component factor
- Interfaces directly with the microcontroller
- Direct interface with the microcontroller for the ACST4-7S ( $I_{GT} < 10mA$ )

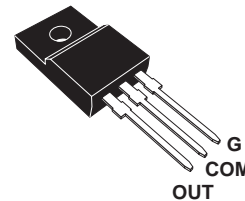
#### DESCRIPTION

The ACST4 belongs to the AC power switch family built around the ASD™ technology. This high performance device is adapted to home appliances or industrial systems and drives loads up to 4 A.

The ACS™ switch embeds a Triac structure with a high voltage clamping device to absorb the inductive turn-off energy and withstand line transients such as those described in the IEC61000-4-5 standards.

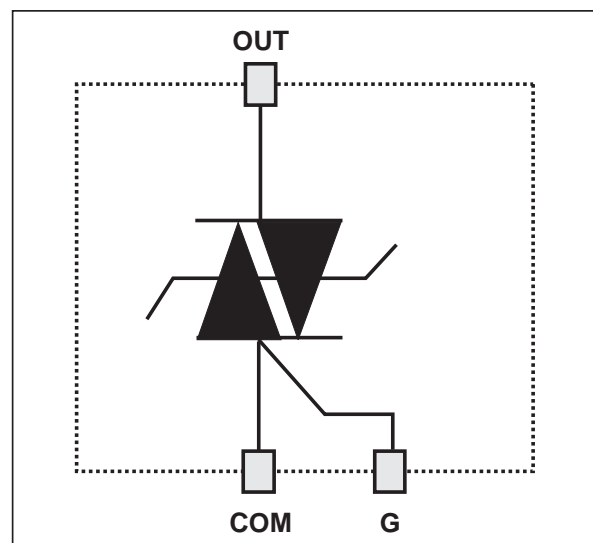


DPAK  
ACST4-7SB/CB



TO-220FPAB  
ACST4-7SFP/CFP

#### FUNCTIONAL DIAGRAM



## ACST4 Series

### ABSOLUTE RATINGS (limiting values)

For either positive or negative polarity of pin OUT voltage in respect to pin COM voltage

Symbol	Parameter		Value	Unit	
$V_{DRM} / V_{RRM}$	Repetitive peak off-state voltage		$T_j = -10\text{ °C}$	700	V
$I_{T(RMS)}$	RMS on-state current full cycle sine wave 50 to 60 Hz	DPAK	$T_c = 110\text{ °C}$	4	A
		TO-220FPAB	$T_c = 100\text{ °C}$		
$I_{TSM}$	Non repetitive surge peak on-state current $T_j$ initial = 25°C, full cycle sine wave		F = 50 Hz	30	A
			F = 60 Hz	33	A
$I^2t$	Fusing capability		$t_p = 10\text{ms}$	6.4	A <sup>2</sup> s
$di/dt$	Repetitive on-state current critical rate of rise $I_G = 10\text{mA}$ ( $t_r < 100\text{ns}$ )	$T_j = 125\text{ °C}$	F = 120 Hz	50	A/ $\mu\text{s}$
$V_{PP}$	Non repetitive line peak pulse voltage		note 1	2	kV
$T_{stg}$	Storage temperature range			- 40 to + 150	°C
$T_j$	Operating junction temperature range			- 30 to + 125	°C
$T_l$	Maximum lead soldering temperature during 10s			260	°C

Note 1: according to test described by IEC61000-4-5 standard & Figure B.

### GATE CHARACTERISTICS (maximum values)

Symbol	Parameter	Value	Unit
$P_{G(AV)}$	Average gate power dissipation	0.1	W
$P_{GM}$	Peak gate power dissipation ( $t_p = 20\mu\text{s}$ )	10	A
$I_{GM}$	Peak gate current ( $t_p = 20\mu\text{s}$ )	1	V

### THERMAL RESISTANCES

Symbol	Parameter		Value	Unit
$R_{th(j-a)}$	Junction to ambient	S = 0.5cm <sup>2</sup>   DPAK	70	°C/W
		TO-220FPAB	60	°C/W
$R_{th(j-l)}$	Junction to case for full cycle sine wave conduction	DPAK	2.6	°C/W
		TO-220FPAB	4.6	°C/W

S = Copper surface under Tab

## PARAMETER DESCRIPTION

Parameter Symbol	Parameter description
$I_{GT}$	Triggering gate current
$V_{GT}$	Triggering gate voltage
$V_{GD}$	Non-triggering gate voltage
$I_H$	Holding current
$I_L$	Latching current
$V_{TM}$	Peak on-state voltage drop
$V_{TO}$	On state threshold voltage
$R_d$	On state dynamic resistance
$I_{DRM} / I_{RRM}$	Maximum forward or reverse leakage current
$dV/dt$	Critical rate of rise of off-state voltage
$(dV/dt)_c$	Critical rate of rise of commutating off-state voltage
$(dI/dt)_c$	Critical rate of decrease of commutating on-state current
$V_{CL}$	Clamping voltage
$I_{CL}$	Clamping current

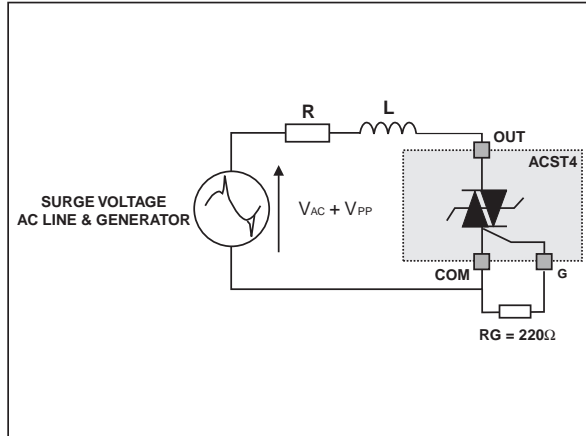
## ELECTRICAL CHARACTERISTICS

For either positive or negative polarity of pin OUT voltage in respect to pin COM voltage.

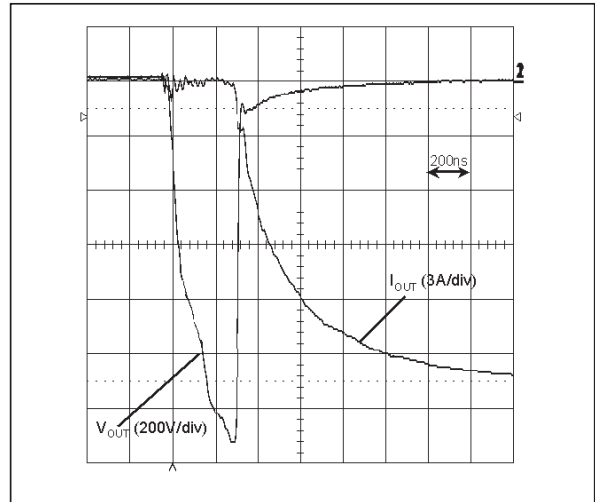
Symbol	Test Conditions				ACST4-7S	ACST4-7C	Unit
$I_{GT}$	$V_{OUT}=12V$ (DC) $R_L=33\Omega$	QI - QII - QIII	$T_j=25^\circ C$	MAX	10	25	mA
$V_{GT}$	$V_{OUT}=12V$ (DC) $R_L=33\Omega$	QI - QII - QIII	$T_j=25^\circ C$	MAX	1	1.1	V
$V_{GD}$	$V_{OUT}=V_{DRM}$ $R_L=3.3k\Omega$		$T_j=125^\circ C$	MIN	0.2		V
$I_H$	$I_{OUT}=100mA$ gate open		$T_j=25^\circ C$	MAX	20	35	mA
$I_L$	$I_G=2 \times I_{GTmax}$		$T_j=25^\circ C$	MAX	40	60	mA
$V_{TM}$	$I_{OUT}=5.6A$ $t_p=380\mu s$		$T_j=25^\circ C$	MAX	1.5		V
$V_{TO}$			$T_j=125^\circ C$	MAX	0.90		V
$R_d$			$T_j=125^\circ C$	MAX	100		m $\Omega$
$I_{DRM} / I_{RRM}$	$V_{OUT}=700V$		$T_j=25^\circ C$	MAX	10		$\mu A$
			$T_j=125^\circ C$	MAX	500		
$dV/dt$	$V_{OUT}=460V$ gate open		$T_j=110^\circ C$	MIN	200	500	V/ $\mu s$
$(dI/dt)_c$	$(dV/dt)_c=20V/\mu s$		$T_j=125^\circ C$	MIN	2.0	2.5	A/ms
$V_{CL}$	$I_{CL}=1mA$ $t_p=1ms$		$T_j=25^\circ C$	TYP	1100		V



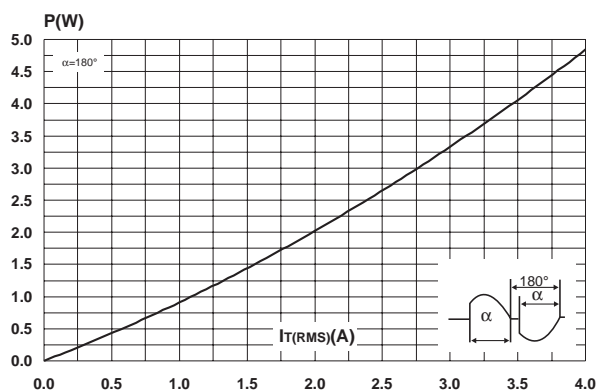
**Fig. B:** Overvoltage ruggedness test circuit for resistive and inductive loads according to IEC61000-4-5 standards.  
 $R = 150\Omega$ ,  $L = 10\mu\text{H}$ ,  $V_{PP} = 2\text{kV}$ .



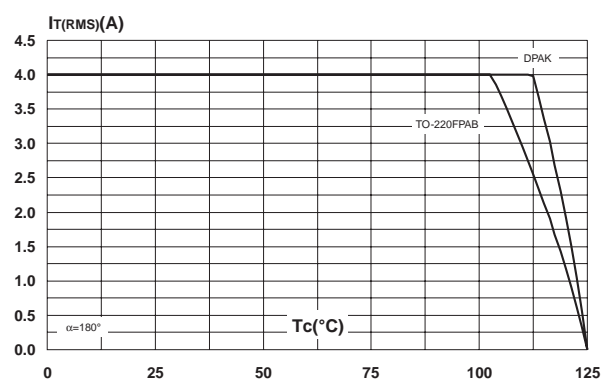
**Fig. C:** Current and Voltage of the ACST4 during IEC61000-4-5 standard test with R, L &  $V_{PP}$ .



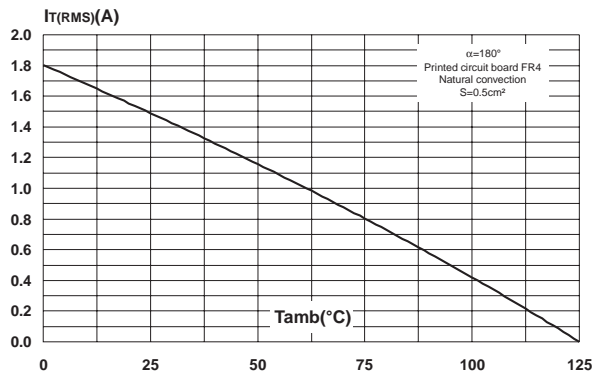
**Fig. 1:** Maximum power dissipation versus RMS on-state current.



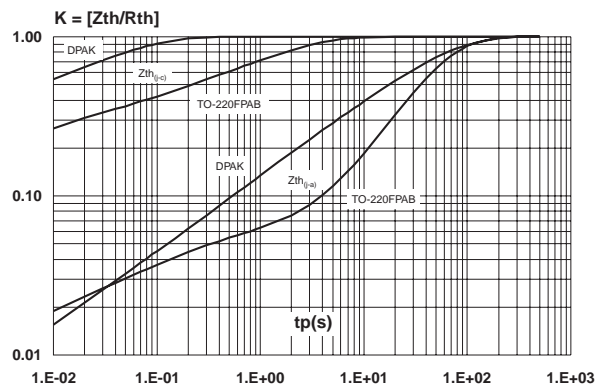
**Fig. 2-1:** RMS on-state current versus case temperature.



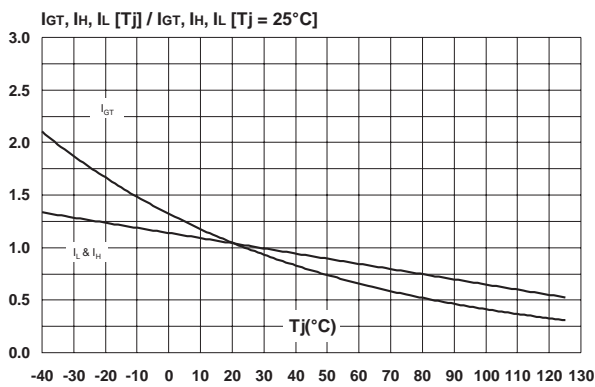
**Fig. 2-2:** RMS on-state current versus ambient temperature.



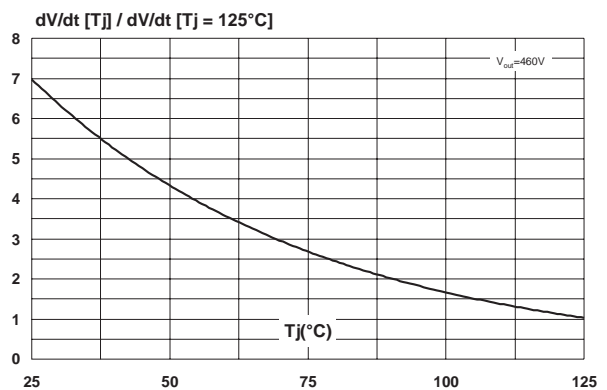
**Fig. 3:** Relative variation of thermal impedance versus pulse duration.



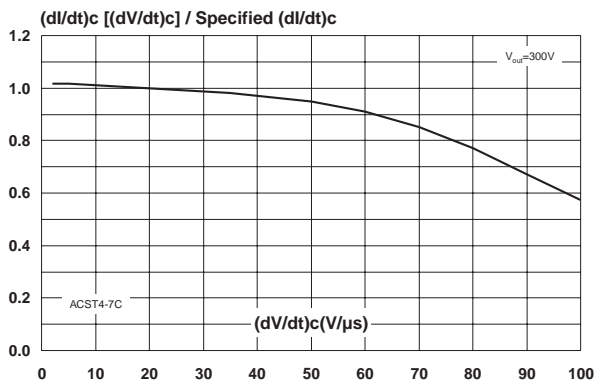
**Fig. 4:** Relative variation of gate trigger current, holding current and latching versus junction temperature (typical values).



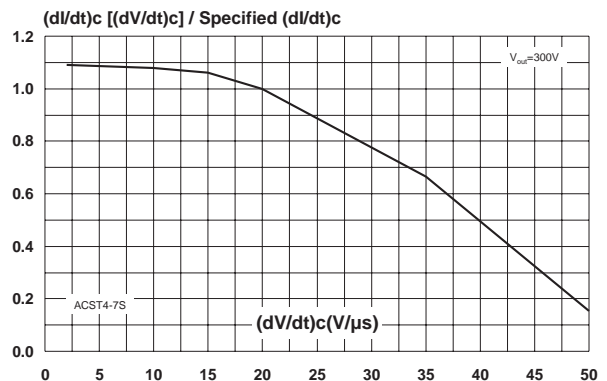
**Fig. 5:** Relative variation of static dV/dt versus junction temperature.



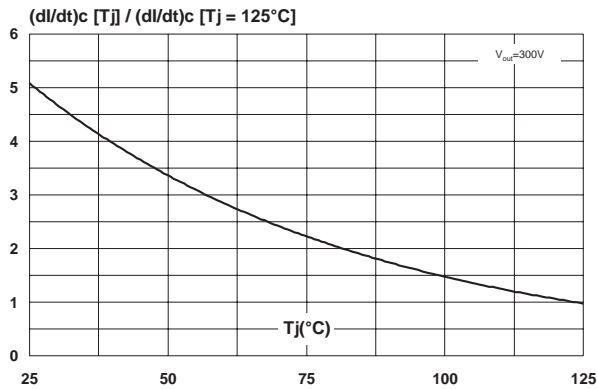
**Fig. 6-1:** Relative variation of critical rate of decrease of main current versus reapplied dV/dt (typical values).



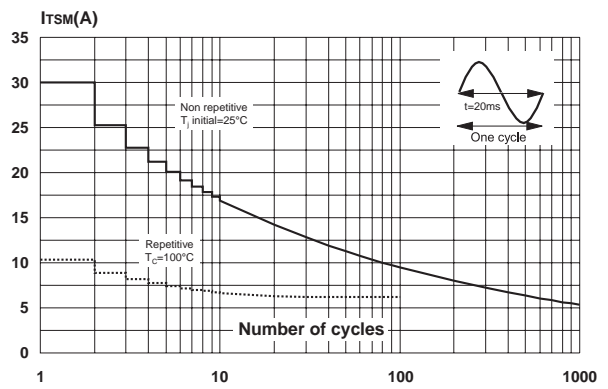
**Fig. 6-2:** Relative variation of critical rate of decrease of main current versus reapplied dV/dt (typical values).



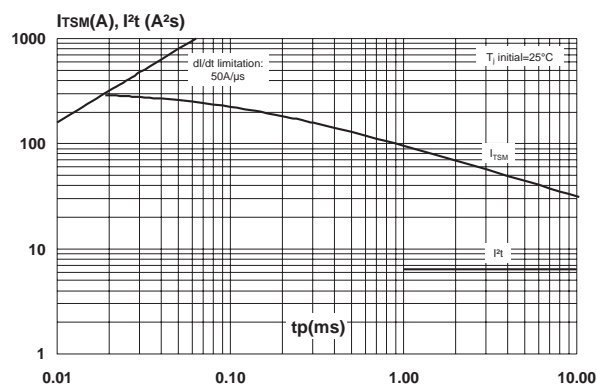
**Fig. 7:** Relative variation of critical rate of decrease of main current versus junction temperature.



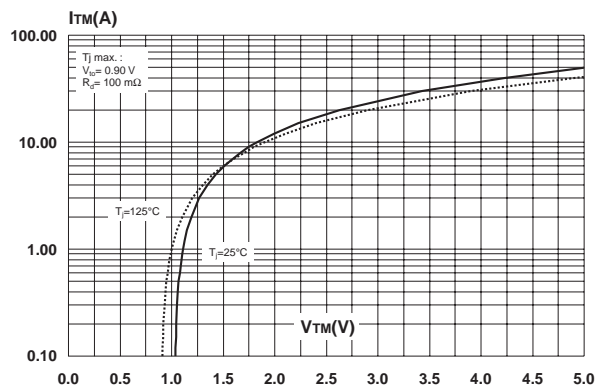
**Fig. 8:** Surge peak on-state current versus number of cycles.



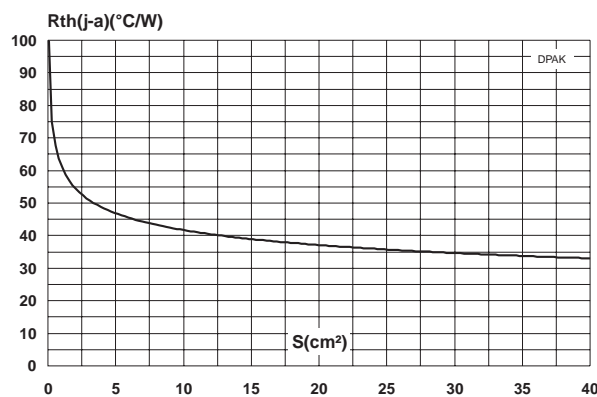
**Fig. 9:** Non repetitive surge peak on-state current for a sinusoidal pulse with width  $t_p < 10\text{ms}$ , and corresponding value of  $I^2t$ .



**Fig. 10:** On-state characteristics (maximum values).

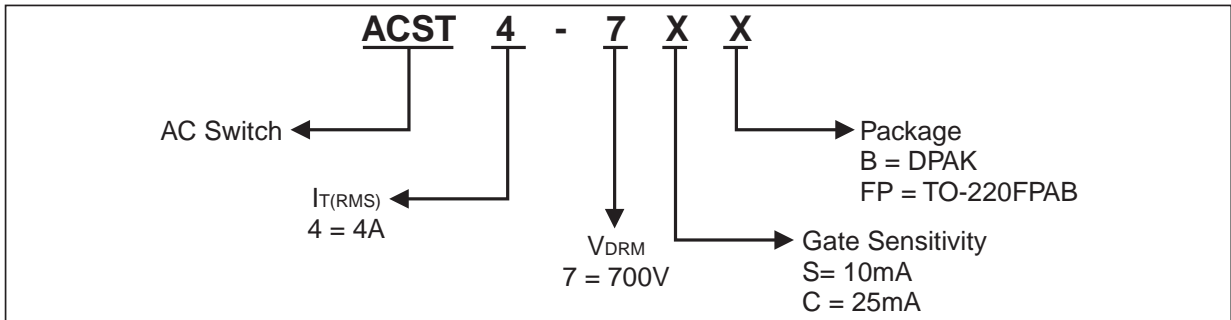


**Fig. 11:** Thermal resistance junction to ambient versus copper surface under tab (printed circuit board FR4, copper thickness:  $35\mu\text{m}$ )

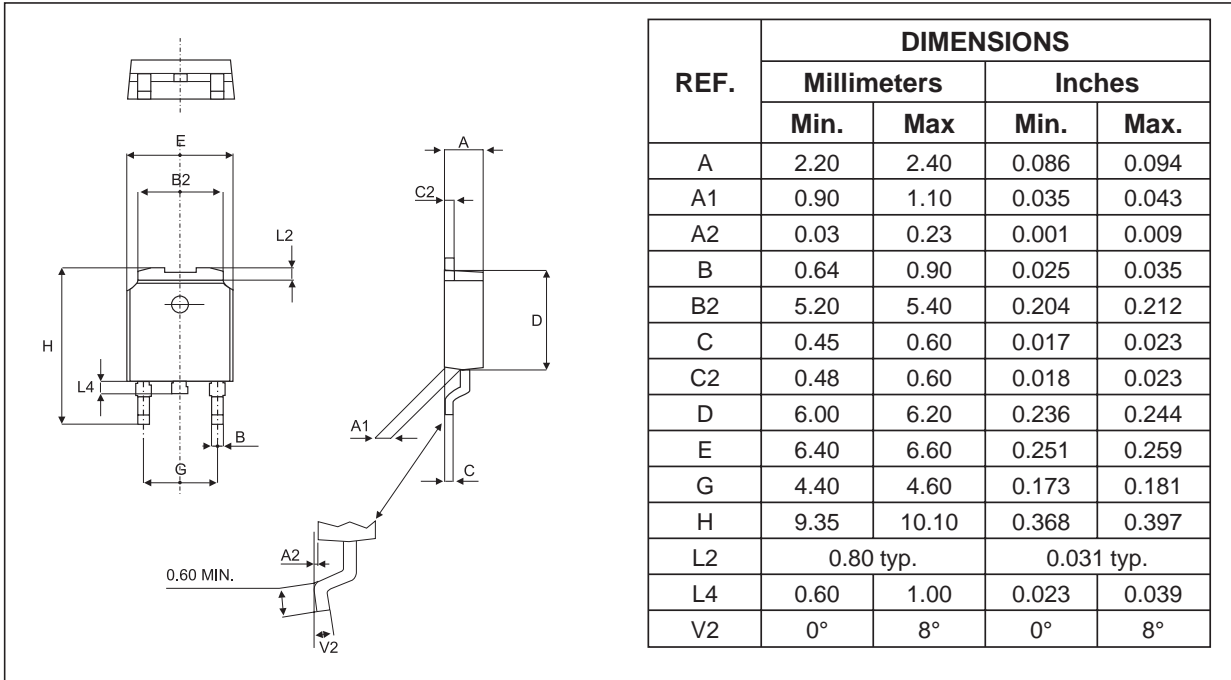


# ACST4 Series

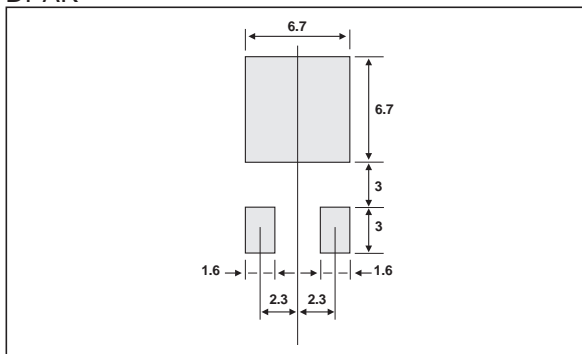
## ORDERING INFORMATION



## PACKAGE OUTLINE MECHANICAL DATA DPAK



## FOOT PRINT DPAK



**PACKAGE OUTLINE MECHANICAL DATA**  
**TO-220FPAB**

REF.	DIMENSIONS			
	Millimeters		Inches	
	Min.	Max.	Min.	Max.
A	4.4	4.6	0.173	0.181
B	2.5	2.7	0.098	0.106
D	2.5	2.75	0.098	0.108
E	0.45	0.70	0.018	0.027
F	0.75	1	0.030	0.039
F1	1.15	1.70	0.045	0.067
F2	1.15	1.70	0.045	0.067
G	4.95	5.20	0.195	0.205
G1	2.4	2.7	0.094	0.106
H	10	10.4	0.393	0.409
L2	16 Typ.		0.63 Typ.	
L3	28.6	30.6	1.126	1.205
L4	9.8	10.6	0.386	0.417
L5	2.9	3.6	0.114	0.142
L6	15.9	16.4	0.626	0.646
L7	9.00	9.30	0.354	0.366

**OTHER INFORMATION**

Ordering type	Marking	Package	Weight	Base qty	Delivery mode
ACST4-7SB	ACST47S	DPAK	0.3 g	75	Tube
ACST4-7SB-TR	ACST47S	DPAK	0.3 g	2500	Tape & reel
ACST4-7SFP	ACST47S	TO-220FPAB	2.4 g	50	Tube
ACST4-7CB	ACST47C	DPAK	0.3 g	75	Tube
ACST4-7CB-TR	ACST47C	DPAK	0.3 g	2500	Tape & reel
ACST4-7CFP	ACST47C	TO-220FPAB	2.4 g	50	Tube

- Epoxy meets UL94,V0

Information furnished is believed to be accurate and reliable. However, STMicroelectronics assumes no responsibility for the consequences of use of such information nor for any infringement of patents or other rights of third parties which may result from its use. No license is granted by implication or otherwise under any patent or patent rights of STMicroelectronics. Specifications mentioned in this publication are subject to change without notice. This publication supersedes and replaces all information previously supplied. STMicroelectronics products are not authorized for use as critical components in life support devices or systems without express written approval of STMicroelectronics.

The ST logo is a registered trademark of STMicroelectronics

© 2002 STMicroelectronics - Printed in Italy - All rights reserved.

STMicroelectronics GROUP OF COMPANIES

Australia - Brazil - Canada - China - Finland - France - Germany  
 Hong Kong - India - Israel - Italy - Japan - Malaysia - Malta - Morocco - Singapore  
 Spain - Sweden - Switzerland - United Kingdom - United States.

<http://www.st.com>





LittleDiode supplies new, hard to find or obsolete electronic components and semiconductors all over the world.

With over two million different components listed you are sure to find the part you need.

Feel free to visit us today at our online store:

[LittleDiode.com](http://LittleDiode.com)

Looking forward to providing you with the best possible service.