

Powerex, Inc., 200 Hillis Street, Youngwood, Pennsylvania 15697-1800 (412) 925-7272
 Powerex, Europe, S.A. 428 Avenue G. Durand, BP107, 72003 Le Mans, France (43) 41.14.14

Phase Control SCR
 1500 Amperes Average
 2400 Volts

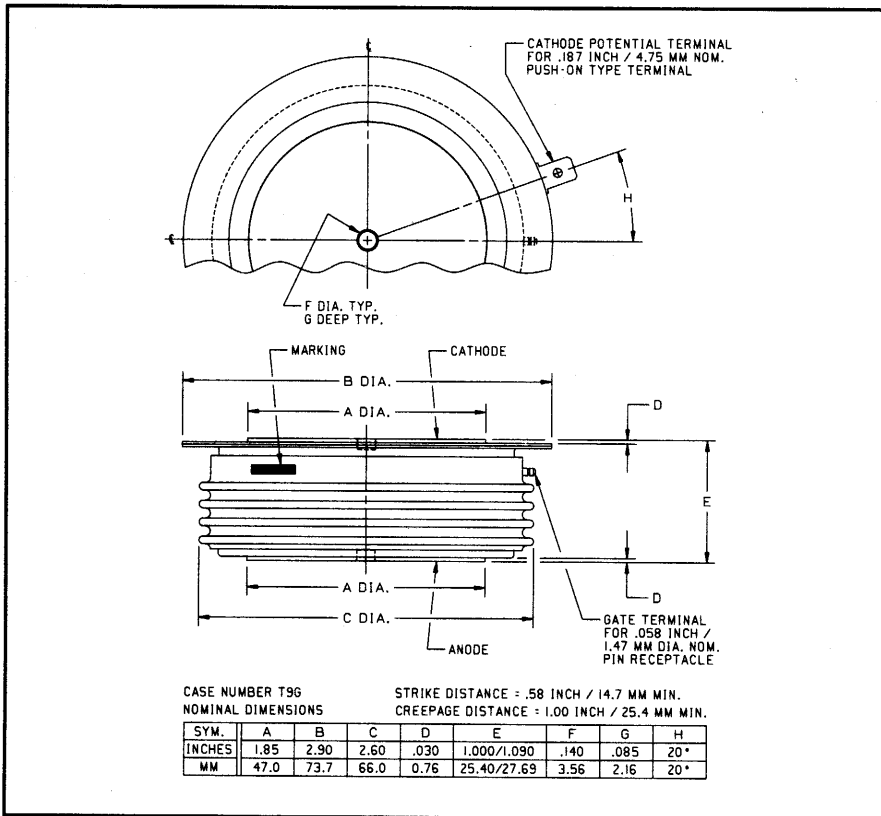

C451 (Outline Drawing)

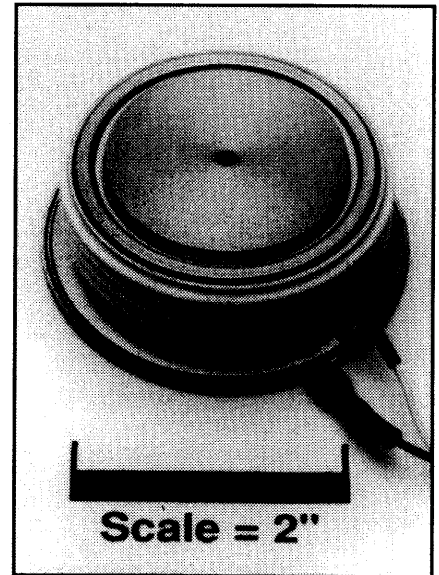

C451 Phase Control SCR
 1500 Amperes Average, 2400 Volts

Ordering Information:

Select the complete five or six digit part number you desire from the table, i.e. C451LD is a 2400 Volt, 1500 Ampere Phase Control SCR.

Type	Voltage		Current
	V _{DRM} V _{RRM}	Code	I _{T(av)}
C451	1400	PD	1500
	1600	PM	
	1800	PN	
	2000	L	
	2200	LB	
	2400	LD	

Description:

Powerex Silicon Controlled Rectifiers (SCR) are designed for phase control applications. These are all-diffused, Press-Pak, hermetic Pow-R-Disc devices employing the field proven amplifying gate.

Features:

- Low On-State Voltage
- High di/dt Capability
- High dv/dt Capability
- Hermetic Packaging
- Excellent Surge and I²t Ratings

Applications:

- Power Supplies
- Motor Control
- VAR Generators



Powerex, Inc., 200 Hillis Street, Youngwood, Pennsylvania 15697-1800 (412) 925-7272
Powerex, Europe, S.A. 428 Avenue G. Durand, BP107, 72003 Le Mans, France (43) 41.14.14

C451
Phase Control SCR
1500 Amperes Average, 2400 Volts

Absolute Maximum Ratings

Characteristics	Symbol	C451	Units
Non-repetitive Transient Peak Reverse Voltage	V_{RSM}	$V_{RRM} + 100V$	Volts
RMS On-state Current, $T_C = 64^\circ C$	$I_{T(rms)}$	2350	Amperes
Average Current 180° Sine Wave, $T_C = 64^\circ C$	$I_{T(av)}$	1500	Amperes
RMS On-state Current, $T_C = 55^\circ C$	$I_{T(rms)}$	2590	Amperes
Average Current 180° Sine Wave, $T_C = 55^\circ C$	$I_{T(av)}$	1650	Amperes
Peak One Cycle Surge On-state Current (Non-repetitive) 60Hz	I_{tsm}	23000	Amperes
Peak One Cycle Surge On-state Current (Non-repetitive) 50Hz	I_{tsm}	20800	Amperes
Critical Rate-of-rise of On-state Current (Non-repetitive)	di/dt	400	A/ μ sec
Critical Rate-of-rise of On-state Current (Repetitive)	di/dt	75	A/ μ sec
I^2t (for Fusing) for One Cycle, 60Hz	I^2t	2.2×10^6	A ² sec
Peak Gate Power Dissipation	P_{GM}	200	Watts
Average Gate Power Dissipation	$P_{G(av)}$	5	Watts
Operating Temperature	T_j	-40 to +125°C	°C
Storage Temperature	T_{stg}	-40 to +150°C	°C
Approximate Weight		1	lb.
		454	g
Mounting Force		5500 to 6000	lb.
		2450 to 2670	kg.



Powerex, Inc., 200 Hillis Street, Youngwood, Pennsylvania 15697-1800 (412) 925-7272
 Powerex, Europe, S.A. 428 Avenue G. Durand, BP107, 72003 Le Mans, France (43) 41.14.14

C451
 Phase Control SCR
 1500 Amperes Average, 2400 Volts

Electrical Characteristics, $T_j = 25^\circ\text{C}$ Unless Otherwise Specified

Characteristics	Symbol	Test Conditions	Min.	Typ.	Max.	Units
Repetitive Peak Reverse Leakage Current	I_{RRM}	$T_j = 125^\circ\text{C}, V_R = V_{RRM}$			45	mA
Repetitive Peak Forward Leakage Current	I_{DRM}	$T_j = 125^\circ\text{C}, V_D = V_{DRM}$			45	mA
Peak On-state Voltage	V_{TM}	$I_{TM} = 3000\text{A Peak}$ Duty Cycle < 0.1%			1.7	Volts
Threshold Voltage, Low-level	$V_{(TO)1}$	$T_j = 125^\circ\text{C}, I = 15\%, I_{T(av)}$ to $\pi I_{T(av)}$			0.87956	Volts
Slope Resistance, Low-level	r_{T1}				0.2271	m Ω
Threshold Voltage, High-level	$V_{(TO)2}$	$T_j = 125^\circ\text{C}, I = \pi I_{T(av)}$ to I_{TSM}			0.59931	Volts
Slope Resistance, High-level	r_{T2}				0.2781	m Ω
V_{TM} Coefficients, Low-level		$T_j = 125^\circ\text{C}, I = 15\% I_{T(av)}$ to $\pi I_{T(av)}$				
					$A_1 = 0.83982$	
					$B_1 = 4.972\text{E-}04$	
					$C_1 = 2.032\text{E-}04$	
					$D_1 = 0.002154$	
V_{TM} Coefficients, High-level		$T_j = 125^\circ\text{C}, I = \pi I_{T(av)}$ to I_{TSM}				
					$A_2 = 12.127$	
					$B_2 = -1.8090$	
					$C_2 = 1.429\text{E-}04$	
					$D_2 = 0.064436$	
Typical Delay Time	t_d	$I_T = 50\text{A}, \text{Gate} = 20\text{V}, 20\Omega,$ 0.1 μsec Rise		0.7		μsec
Typical Turn-off Time	t_q	$T_j = 125^\circ\text{C}, I_T = 2000\text{A},$ $di_R/dt = 25\text{A}/\mu\text{sec}$ Reapplied $dv/dt = 200\text{V}/\mu\text{sec}$ Linear to 80% $V_{DRM}, V_R = 50\text{V},$ Gate = 0V, $R_{GK} = 100\Omega$		150		μsec
Minimum Critical dv/dt - Exponential to V_{DRM}	dv/dt	$T_j = 125^\circ\text{C}$	400			V/ μsec
Gate Trigger Current	I_{GT}	$T_j = 25^\circ\text{C},$ $V_D = 20V_{DC}, R_L = 3\Omega$			200	mA
Gate Trigger Voltage	V_{GT}	$T_j = -40^\circ\text{C}$ to $+125^\circ\text{C},$ $V_D = 20\text{V}, R_L = 3\Omega$			5.0	Volts
Non-Triggering Gate Voltage	V_{GDM}	$T_j = 125^\circ\text{C},$ $V_D = V_{DRM}, R_L = 1000\Omega$			0.15	Volts
Peak Forward Gate Current	I_{GTM}				10	A
Peak Reverse Gate Voltage	V_{GRM}				5	Volts

Thermal Characteristics

Maximum Thermal Resistance, Double Sided Cooling

Junction-to-Case	$R_{\theta(j-c)}$	0.025	$^\circ\text{C/W}$
Case-to-Sink	$R_{\theta(c-s)}$	0.0075	$^\circ\text{C/W}$

Powerex, Inc., 200 Hillis Street, Youngwood, Pennsylvania 15697-1800 (412) 925-7272
 Powerex, Europe, S.A. 428 Avenue G. Durand, BP107, 72003 Le Mans, France (43) 41.14.14

C451
Phase Control SCR
 1500 Amperes Average, 2400 Volts

Maximum On-State Forward Voltage Drop
 ($T_J = 125^\circ\text{C}$)

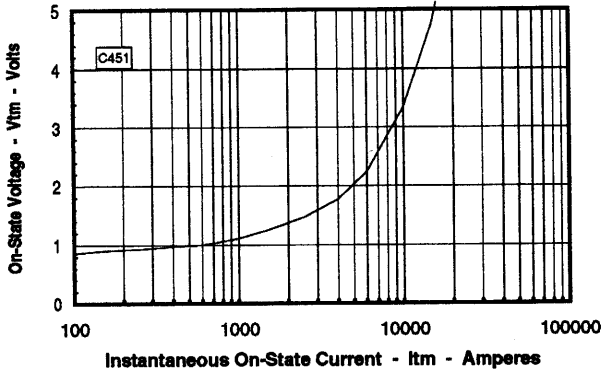

Maximum Transient Thermal Impedance
 (Junction to Case)

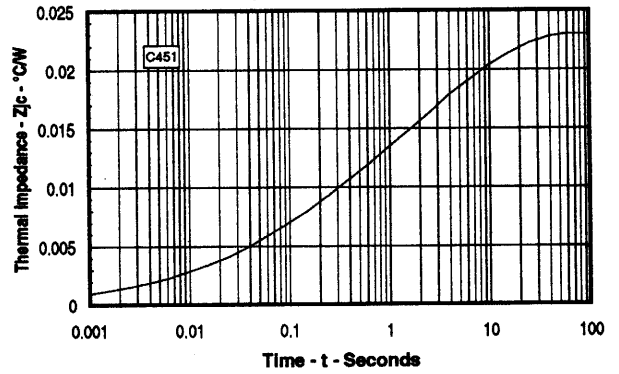

Maximum On-State Power Dissipation
 (Sinusoidal Waveform)

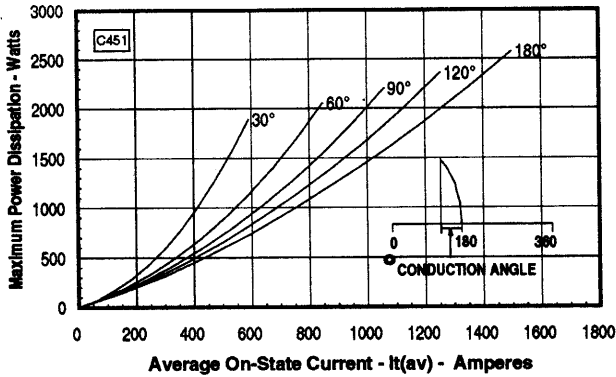

Maximum Allowable Case Temperature
 (Sinusoidal Waveform)

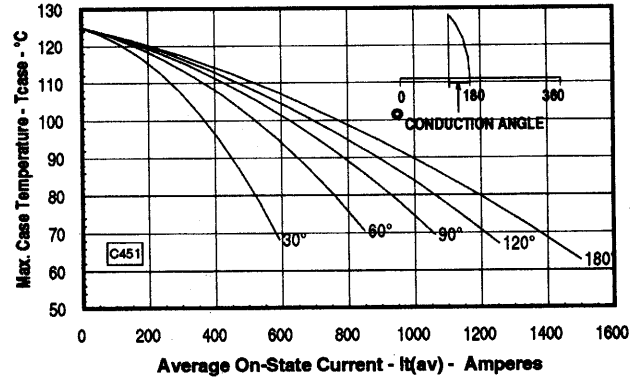

Maximum On-State Power Dissipation
 (Rectangular Waveform)

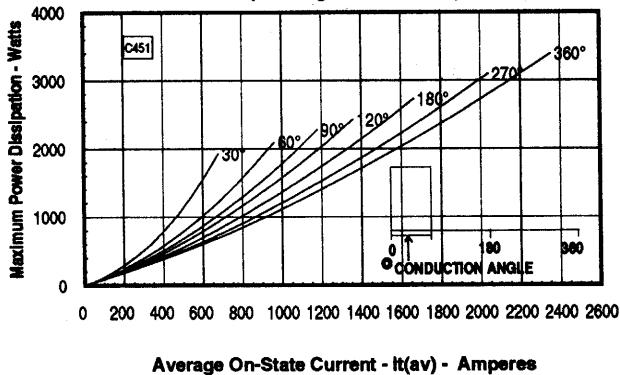

Maximum Allowable Case Temperature
 (Rectangular Waveform)

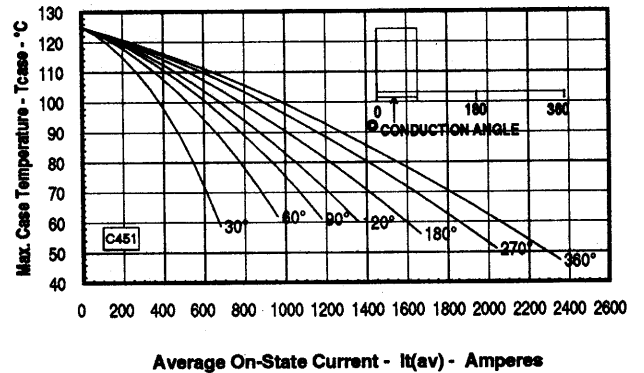



LittleDiode supplies new, hard to find or obsolete electronic components and semiconductors all over the world.

With over two million different components listed you are sure to find the part you need.

Feel free to visit us today at our online store:

LittleDiode.com

Looking forward to providing you with the best possible service.