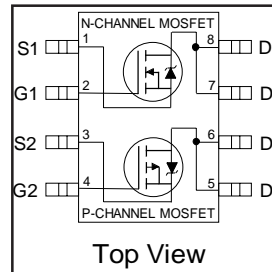


# IRF7105

HEXFET® Power MOSFET

- Advanced Process Technology
- Ultra Low On-Resistance
- Dual N and P Channel Mosfet
- Surface Mount
- Available in Tape & Reel
- Dynamic dv/dt Rating
- Fast Switching

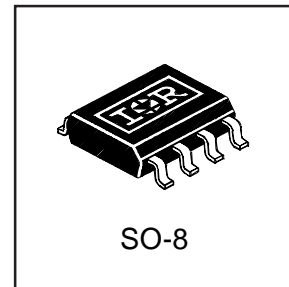


	N-Ch	P-Ch
$V_{DSS}$	25V	-25V
$R_{DS(on)}$	0.10Ω	0.25Ω
$I_D$	3.5A	-2.3A

## Description

Fifth Generation HEXFETs from International Rectifier utilize advanced processing techniques to achieve the lowest possible on-resistance per silicon area. This benefit, combined with the fast switching speed and ruggedized device design that HEXFET Power MOSFETs are well known for, provides the designer with an extremely efficient device for use in a wide variety of applications.

The SO-8 has been modified through a customized leadframe for enhanced thermal characteristics and multiple-die capability making it ideal in a variety of power applications. With these improvements, multiple devices can be used in an application with dramatically reduced board space. The package is designed for vapor phase, infra red, or wave soldering techniques. Power dissipation of greater than 0.8W is possible in a typical PCB mount application.



## Absolute Maximum Ratings

	Parameter	Max.		Units
		N-Channel	P-Channel	
$I_D @ T_A = 25^\circ\text{C}$	Continuous Drain Current, $V_{GS} @ 10\text{V}$	3.5	-2.3	A
$I_D @ T_A = 70^\circ\text{C}$	Continuous Drain Current, $V_{GS} @ 10\text{V}$	2.8	-1.8	
$I_{DM}$	Pulsed Drain Current ①	14	-10	
$P_D @ T_C = 25^\circ\text{C}$	Power Dissipation	2.0		W
	Linear Derating Factor	0.016		W/°C
$V_{GS}$	Gate-to-Source Voltage	$\pm 20$		V
dv/dt	Peak Diode Recovery dv/dt ②	3.0	-3.0	V/nS
$T_J, T_{STG}$	Junction and Storage Temperature Range	-55 to + 150		°C

## Thermal Resistance Ratings

	Parameter	Min.	Typ.	Max.	Units
$R_{\theta JA}$	Maximum Junction-to-Ambient ④	—	—	62.5	°C/W

# IRF7105

International  
 Rectifier

## Electrical Characteristics @ T<sub>J</sub> = 25°C (unless otherwise specified)

Parameter	Description		Min.	Typ.	Max.	Units	Conditions
V <sub>(BR)DSS</sub>	Drain-to-Source Breakdown Voltage	N-Ch	25	—	—	V	V <sub>GS</sub> = 0V, I <sub>D</sub> = 250μA
		P-Ch	-25	—	—		V <sub>GS</sub> = 0V, I <sub>D</sub> = -250μA
ΔV <sub>(BR)DSS</sub> /ΔT <sub>J</sub>	Breakdown Voltage Temp. Coefficient	N-Ch	—	0.030	—	V/°C	Reference to 25°C, I <sub>D</sub> = 1mA
		P-Ch	—	-0.015	—		Reference to 25°C, I <sub>D</sub> = -1mA
R <sub>DS(ON)</sub>	Static Drain-to-Source On-Resistance	N-Ch	—	0.083	0.10	Ω	V <sub>GS</sub> = 10V, I <sub>D</sub> = 1.0A ③
		N-Ch	—	0.14	0.16		V <sub>GS</sub> = 4.5V, I <sub>D</sub> = 0.50A ③
		P-Ch	—	0.16	0.25		V <sub>GS</sub> = -10V, I <sub>D</sub> = -1.0A ③
		P-Ch	—	0.30	0.40		V <sub>GS</sub> = -4.5V, I <sub>D</sub> = -0.50A ③
V <sub>GS(th)</sub>	Gate Threshold Voltage	N-Ch	1.0	—	3.0	V	V <sub>DS</sub> = V <sub>GS</sub> , I <sub>D</sub> = 250μA
		P-Ch	-1.0	—	-3.0		V <sub>DS</sub> = V <sub>GS</sub> , I <sub>D</sub> = -250μA
g <sub>fs</sub>	Forward Transconductance	N-Ch	—	4.3	—	S	V <sub>DS</sub> = 15V, I <sub>D</sub> = 3.5A ③
		P-Ch	—	3.1	—		V <sub>DS</sub> = -15V, I <sub>D</sub> = -3.5A ③
I <sub>DSS</sub>	Drain-to-Source Leakage Current	N-Ch	—	—	2.0	μA	V <sub>DS</sub> = 20V, V <sub>GS</sub> = 0V
		P-Ch	—	—	-2.0		V <sub>DS</sub> = -20V, V <sub>GS</sub> = 0V
		N-Ch	—	—	25		V <sub>DS</sub> = 20V, V <sub>GS</sub> = 0V, T <sub>J</sub> = 55°C
		P-Ch	—	—	-25		V <sub>DS</sub> = -20V, V <sub>GS</sub> = 0V, T <sub>J</sub> = 55°C
I <sub>GSS</sub>	Gate-to-Source Forward Leakage	N-P	—	—	±100		V <sub>GS</sub> = ± 20V
Q <sub>g</sub>	Total Gate Charge	N-Ch	—	9.4	27	nC	N-Channel I <sub>D</sub> = 2.3A, V <sub>DS</sub> = 12.5V, V <sub>GS</sub> = 10V ③
P-Ch	—	10	25				
Q <sub>gs</sub>	Gate-to-Source Charge	N-Ch	—	1.7	—	nC	P-Channel I <sub>D</sub> = -2.3A, V <sub>DS</sub> = -12.5V, V <sub>GS</sub> = -10V
P-Ch	—	1.9	—				
Q <sub>gd</sub>	Gate-to-Drain ("Miller") Charge	N-Ch	—	3.1	—	nC	P-Channel I <sub>D</sub> = -2.3A, V <sub>DS</sub> = -12.5V, V <sub>GS</sub> = -10V
P-Ch	—	2.8	—				
t <sub>d(on)</sub>	Turn-On Delay Time	N-Ch	—	7.0	20	ns	N-Channel V <sub>DD</sub> = 25V, I <sub>D</sub> = 1.0A, R <sub>G</sub> = 6.0Ω, R <sub>D</sub> = 25Ω ③
t <sub>r</sub>	Rise Time	N-Ch	—	9.0	20		
		P-Ch	—	13	40		
t <sub>d(off)</sub>	Turn-Off Delay Time	N-Ch	—	45	90		
		P-Ch	—	45	90		
t <sub>f</sub>	Fall Time	N-Ch	—	25	50	ns	P-Channel V <sub>DD</sub> = -25V, I <sub>D</sub> = -1.0A, R <sub>G</sub> = 6.0Ω, R <sub>D</sub> = 25Ω ③
		P-Ch	—	37	50		
L <sub>D</sub>	Internal Drain Inductance	N-P	—	4.0	—	nH	Between lead, 6mm (0.25in.) from package and center of die contact
L <sub>S</sub>	Internal Source Inductance	N-P	—	6.0	—		
C <sub>iss</sub>	Input Capacitance	N-Ch	—	330	—	pF	N-Channel V <sub>GS</sub> = 0V, V <sub>DS</sub> = 15V, f = 1.0MHz
		P-Ch	—	290	—		
C <sub>oss</sub>	Output Capacitance	N-Ch	—	250	—		
		P-Ch	—	210	—		
C <sub>rss</sub>	Reverse Transfer Capacitance	N-Ch	—	61	—	pF	P-Channel V <sub>GS</sub> = 0V, V <sub>DS</sub> = -15V, f = 1.0MHz
		P-Ch	—	67	—		

## Source-Drain Ratings and Characteristics

Parameter	Description		Min.	Typ.	Max.	Units	Conditions
I <sub>S</sub>	Continuous Source Current (Body Diode)	N-Ch	—	—	2.0	A	
		P-Ch	—	—	-2.0		
I <sub>SM</sub>	Pulsed Source Current (Body Diode) ①	N-Ch	—	—	14	A	
		P-Ch	—	—	-9.2		
V <sub>SD</sub>	Diode Forward Voltage	N-Ch	—	—	1.2	V	T <sub>J</sub> = 25°C, I <sub>S</sub> = 1.3A, V <sub>GS</sub> = 0V ③
		P-Ch	—	—	-1.2		T <sub>J</sub> = 25°C, I <sub>S</sub> = -1.3A, V <sub>GS</sub> = 0V ③
t <sub>rr</sub>	Reverse Recovery Time	N-Ch	—	36	54	ns	N-Channel T <sub>J</sub> = 25°C, I <sub>F</sub> = 1.3A, di/dt = 100A/μs ③
		P-Ch	—	69	100		
Q <sub>rr</sub>	Reverse Recovery Charge	N-Ch	—	41	75	nC	P-Channel T <sub>J</sub> = 25°C, I <sub>F</sub> = -1.3A, di/dt = 100A/μs ③
		P-Ch	—	90	180		
t <sub>on</sub>	Forward Turn-On Time	N-P	Intrinsic turn-on time is negligible (turn-on is dominated by L <sub>S</sub> +L <sub>D</sub> )				

### Notes:

- ① Repetitive rating; pulse width limited by max. junction temperature.
- ② N-Channel I<sub>SD</sub> ≤ 3.5A, di/dt ≤ 90A/μs, V<sub>DD</sub> ≤ V<sub>(BR)DSS</sub>, T<sub>J</sub> ≤ 150°C  
P-Channel I<sub>SD</sub> ≤ -2.3A, di/dt ≤ 90A/μs, V<sub>DD</sub> ≤ V<sub>(BR)DSS</sub>, T<sub>J</sub> ≤ 150°C
- ③ Pulse width ≤ 300μs; duty cycle ≤ 2%.
- ④ Surface mounted on FR-4 board, t ≤ 10sec.

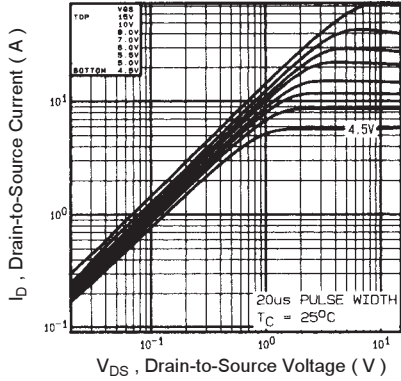


Fig 1. Typical Output Characteristics

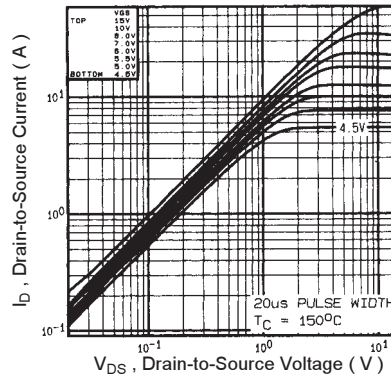


Fig 2. Typical Output Characteristics

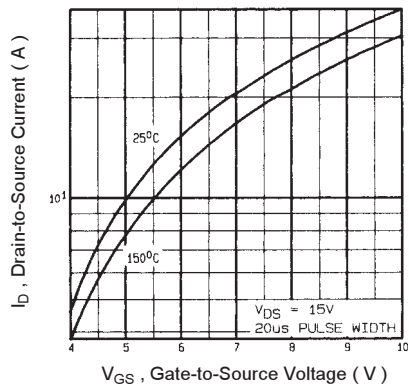


Fig 3. Typical Transfer Characteristics

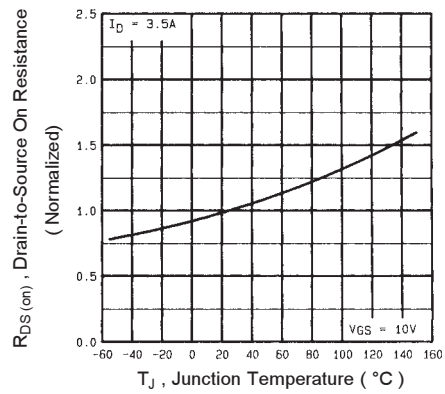


Fig 4. Normalized On-Resistance Vs. Temperature

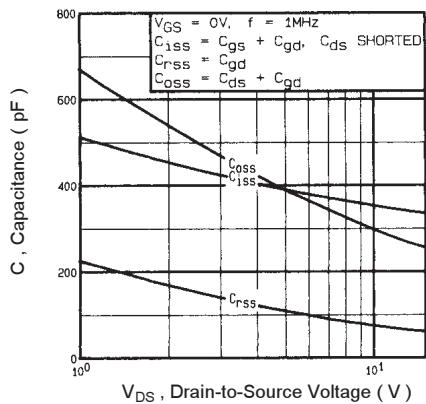


Fig 5. Typical Capacitance Vs. Drain-to-Source Voltage

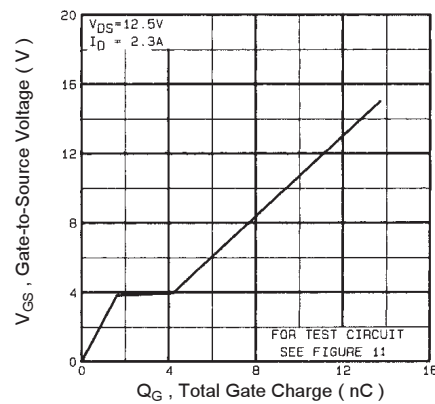
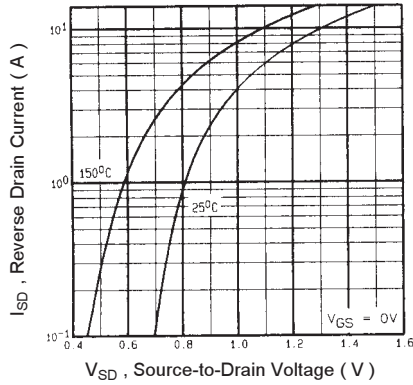


Fig 6. Typical Gate Charge Vs. Gate-to-Source Voltage

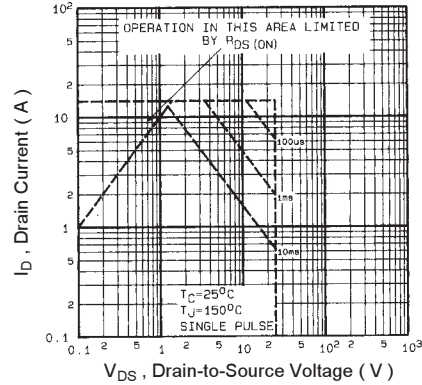
# IRF7105

N-Channel

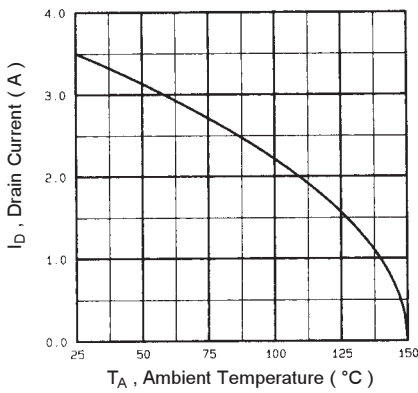
International  
**IR** Rectifier



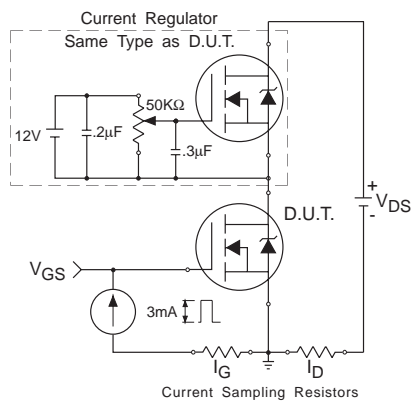
**Fig 7.** Typical Source-Drain Diode Forward Voltage



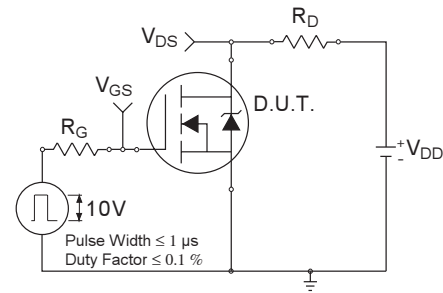
**Fig 8.** Maximum Safe Operating Area



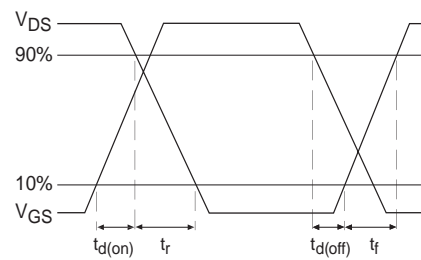
**Fig 9.** Maximum Drain Current Vs. Ambient Temperature



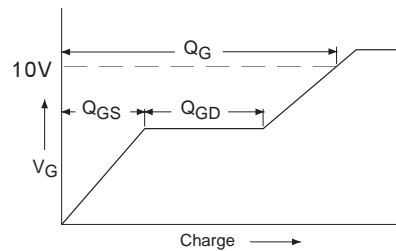
**Fig 11a.** Gate Charge Test Circuit



**Fig 10a.** Switching Time Test Circuit



**Fig 10b.** Switching Time Waveforms



**Fig 11b.** Basic Gate Charge Waveform

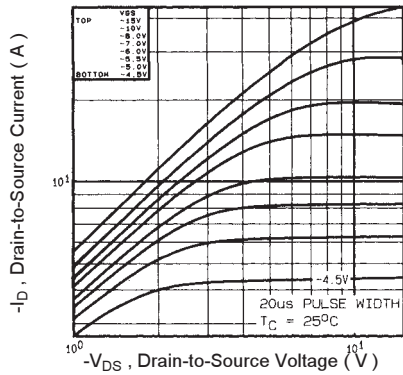


Fig 12. Typical Output Characteristics

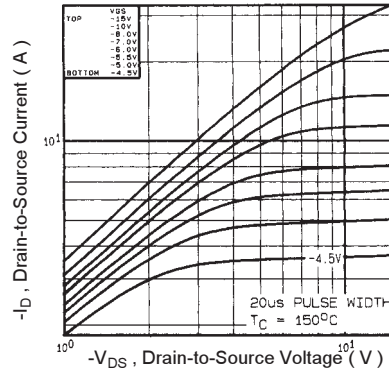


Fig 13. Typical Output Characteristics

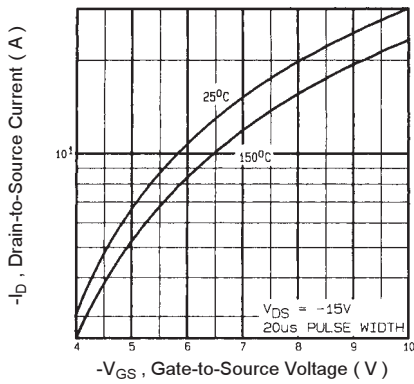


Fig 14. Typical Transfer Characteristics

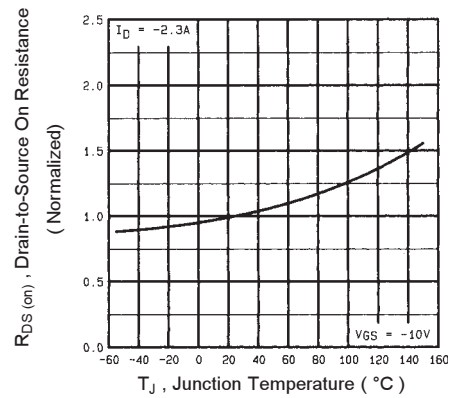


Fig 15. Normalized On-Resistance Vs. Temperature

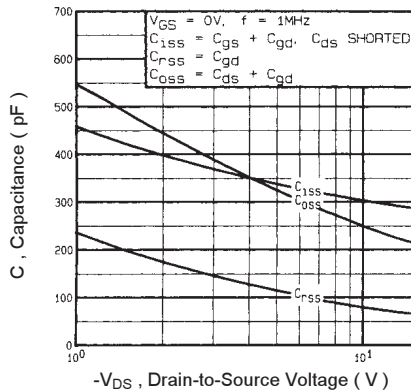


Fig 16. Typical Capacitance Vs. Drain-to-Source Voltage

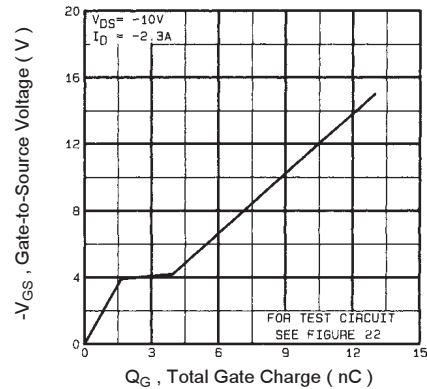
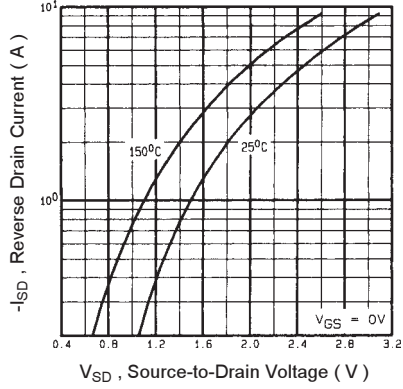


Fig 17. Typical Gate Charge Vs. Gate-to-Source Voltage

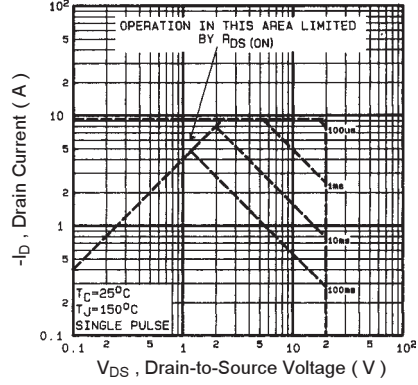
# IRF7105

P-Channel

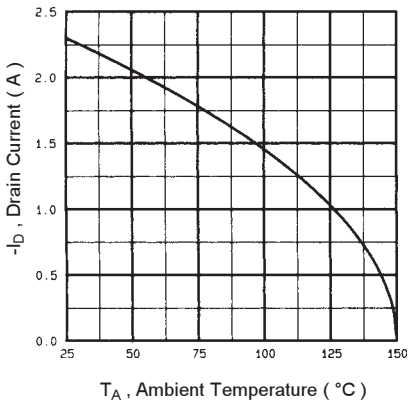
International  
**IR** Rectifier



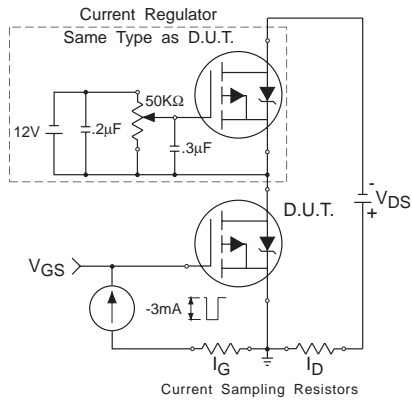
**Fig 18.** Typical Source-Drain Diode Forward Voltage



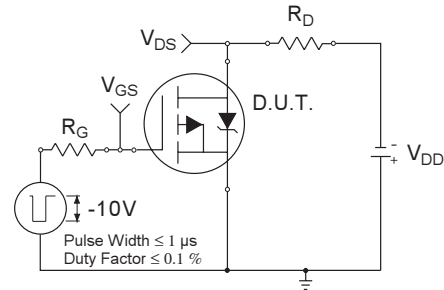
**Fig 19.** Maximum Safe Operating Area



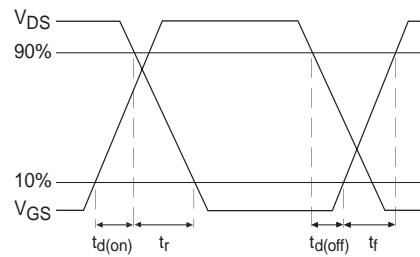
**Fig 20.** Maximum Drain Current Vs. Ambient Temperature



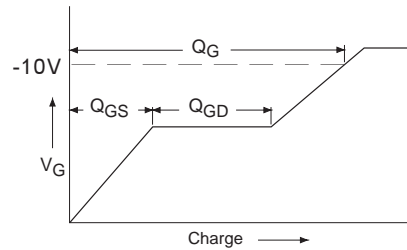
**Fig 22a.** Gate Charge Test Circuit



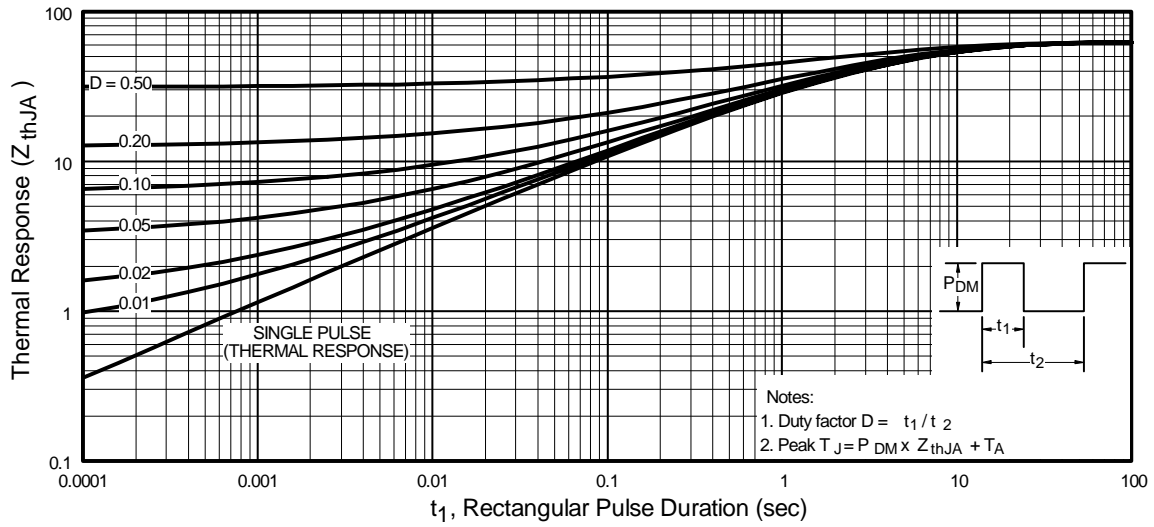
**Fig 21a.** Switching Time Test Circuit



**Fig 21b.** Switching Time Waveforms

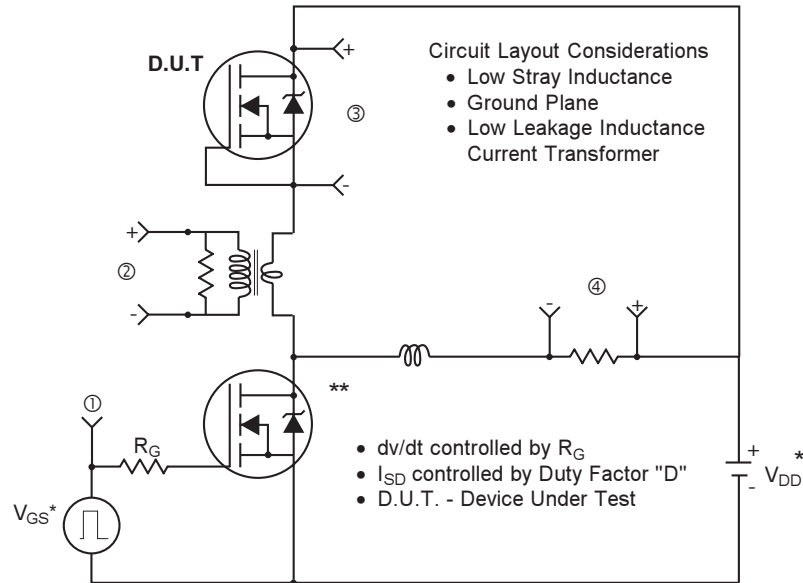


**Fig 22b.** Basic Gate Charge Waveform



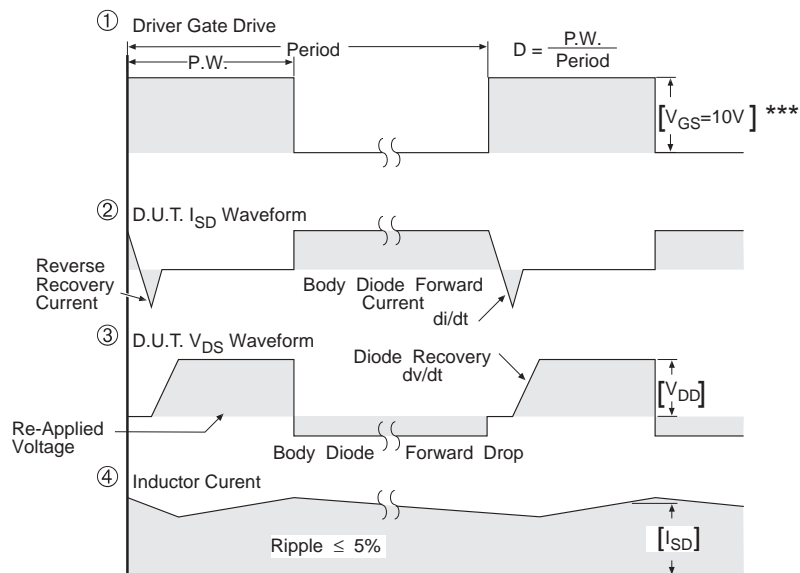
**Fig 23.** Maximum Effective Transient Thermal Impedance, Junction-to-Ambient

## Peak Diode Recovery dv/dt Test Circuit



\* Reverse Polarity for P-Channel

\*\* Use P-Channel Driver for P-Channel Measurements

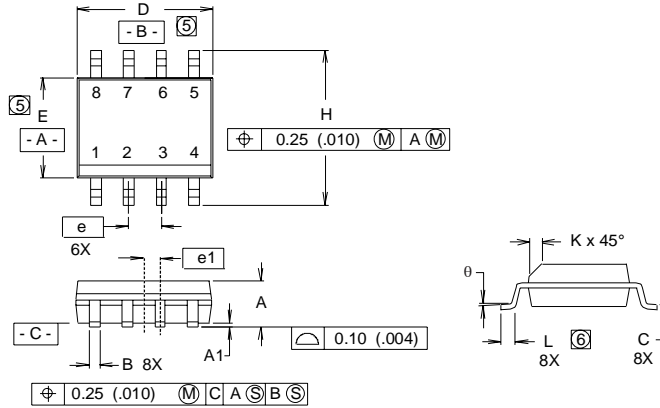


\*\*\*  $V_{GS} = 5.0V$  for Logic Level and 3V Drive Devices

**Fig 24.** For N and P Channel HEXFETS

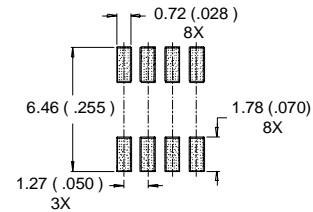
## SO-8 Package Details

Dimensions are shown in millimeters (inches)



DIM	INCHES		MILLIMETERS	
	MIN	MAX	MIN	MAX
A	.0532	.0688	1.35	1.75
A1	.0040	.0098	0.10	0.25
B	.014	.018	0.36	0.46
C	.0075	.0098	0.19	0.25
D	.189	.196	4.80	4.98
E	.150	.157	3.81	3.99
e	.050 BASIC		1.27 BASIC	
e1	.025 BASIC		0.635 BASIC	
H	.2284	.2440	5.80	6.20
K	.011	.019	0.28	0.48
L	0.16	.050	0.41	1.27
θ	0°	8°	0°	8°

### RECOMMENDED FOOTPRINT

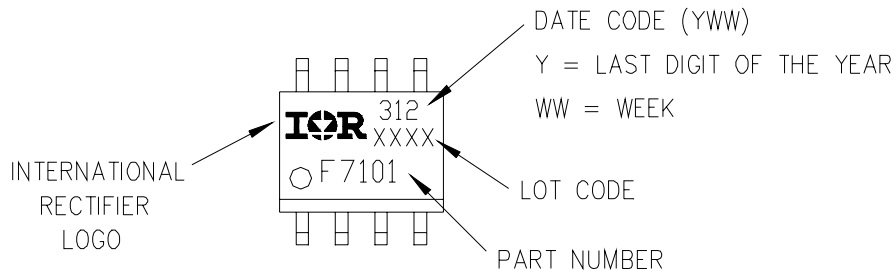


### NOTES:

1. DIMENSIONING AND TOLERANCING PER ANSI Y14.5M-1982.
2. CONTROLLING DIMENSION : INCH.
3. DIMENSIONS ARE SHOWN IN MILLIMETERS (INCHES).
4. OUTLINE CONFORMS TO JEDEC OUTLINE MS-012AA.
- ⑤ DIMENSION DOES NOT INCLUDE MOLD PROTRUSIONS  
MOLD PROTRUSIONS NOT TO EXCEED 0.25 (.006).
- ⑥ DIMENSIONS IS THE LENGTH OF LEAD FOR SOLDERING TO A SUBSTRATE..

## SO-8 Part Marking

EXAMPLE: THIS IS AN IRF7101

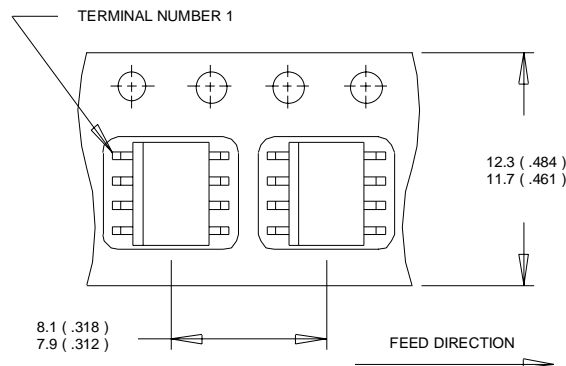


# IRF7105

International  
**IR** Rectifier

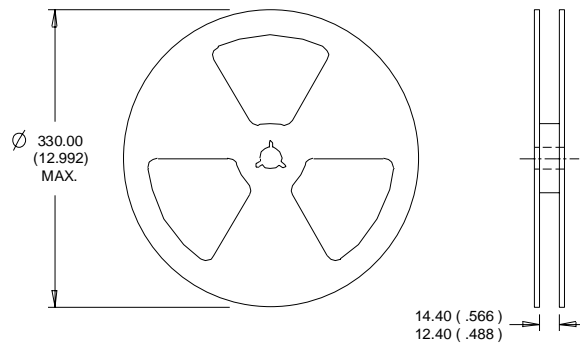
## SO-8 Tape and Reel

Dimensions are shown in millimeters (inches)



**NOTES:**

1. CONTROLLING DIMENSION : MILLIMETER.
2. ALL DIMENSIONS ARE SHOWN IN MILLIMETERS(INCHES).
3. OUTLINE CONFORMS TO EIA-481 & EIA-541.



**NOTES :**

1. CONTROLLING DIMENSION : MILLIMETER.
2. OUTLINE CONFORMS TO EIA-481 & EIA-541.

Data and specifications subject to change without notice.  
This product has been designed and qualified for the Industrial market.  
Qualification Standards can be found on IR's Web site.

International  
**IR** Rectifier

**IR WORLD HEADQUARTERS:** 233 Kansas St., El Segundo, California 90245, USA Tel: (310) 252-7105  
TAC Fax: (310) 252-7903

Visit us at [www.irf.com](http://www.irf.com) for sales contact information.07/03

[www.irf.com](http://www.irf.com)



LittleDiode supplies new, hard to find or obsolete electronic components and semiconductors all over the world.

With over two million different components listed you are sure to find the part you need.

Feel free to visit us today at our online store:

[LittleDiode.com](http://LittleDiode.com)

Looking forward to providing you with the best possible service.