

HYUNDAI
SEMICONDUCTOR

HY6264
8K×8-Bit CMOS SRAM

M221201B-MAY92

T:46-23-12

DESCRIPTION

The HY6264 is a high speed, low power 8,192 words by 8-bit CMOS static RAM fabricated using high performance CMOS process technology. This high reliability process coupled with innovative circuit design techniques, yields maximum access time of 70ns.

The HY6264 has a data retention mode that guarantees data to remain valid at a minimum power supply voltage of 2.0 volt.

Using CMOS technology, supply voltages from 2.0 to 5.5 volts have little effect on supply current in data retention mode. Reducing the supply voltage to minimize current drain is unnecessary with the HY6264 family.

FEATURES

- High speed—70/85/100/120/150ns (max.)
- Low power consumption
 - 200 mW typical operating
 - 10 μW typical standby (L-version)
- Battery back up (L-version)
 - 2 volt data retention
- Fully static operation
 - No clock or refresh required
- All inputs and outputs directly TTL compatible
- Tri-state output
- High reliability 28-pin 600 mil P-DIP and 330 mil SOP

	HY6264-70	HY6264-85	HY6264-100	HY6264-120	HY6264-150
Maximum Access Time (ns)	70	85	100	120	150
Maximum Operating Current (mA)	70	70	70	70	70
Maximum Standby Current (mA)		2	2	2	2
	L	0.1	0.1	0.1	0.1

BLOCK DIAGRAM

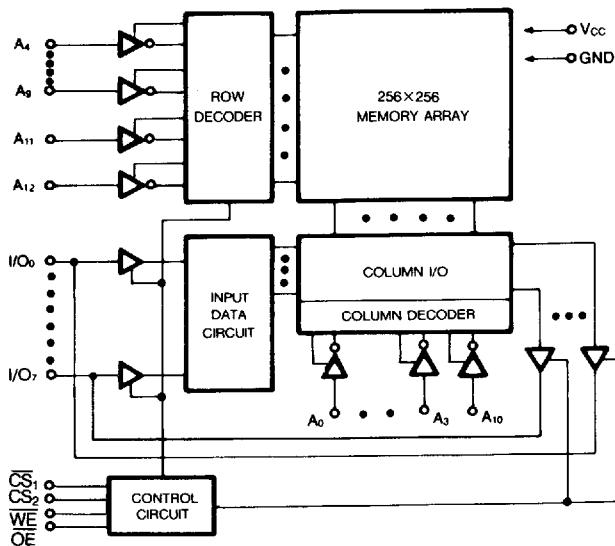

PIN CONNECTIONS

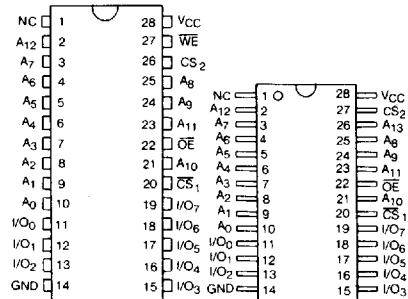

DIP

SOP

PIN NAMES

A ₀ -A ₁₂	ADDRESS INPUT
I/O ₀ -I/O ₇	DATA INPUT/OUTPUT
CS ₁	CHIP SELECT ONE
CS ₂	CHIP SELECT TWO
WE	WRITE ENABLE
OE	OUTPUT ENABLE
V _{CC}	POWER
GND	GROUND

5

HY6264 8,192×8-Bit CMOS SRAM

T-46-23-12

ABSOLUTE MAXIMUM RATINGS⁽¹⁾

SYMBOL	PARAMETER	RATING	UNIT
V _{DD} , V _{IN} , V _{I/O}	Power Supply, Input, Input/Output Voltage	-0.5 ⁽²⁾ to 7.0	V
T _{BIAS}	Temperature Under Bias	-10 to 125	°C
T _{STG}	Storage Temperature	-65 to 150	°C
P _D	Power Dissipation	1.0	W
I _{OUT}	Data Output Current	50	mA

NOTES:

1. Stresses greater than those listed under ABSOLUTE MAXIMUM RATINGS may cause permanent damage to the device. This is a stress rating only and functional operation of the device at these or any other condition above those indicated in the operational sections of this specification is not implied. Exposure to absolute maximum rating conditions for extended periods may affect reliability.

2. -3.5V for 20ns pulse.

RECOMMENDED DC OPERATING CONDITIONS

(T_A=0°C to 70°C)

SYMBOL	PARAMETER	MIN.	TYP.	MAX.	UNIT
V _{CC}	Supply Voltage	4.5	5.0	5.5	V
V _{IH}	Input High Voltage	2.2	3.5	6.0	V
V _{IL}	Input Low Voltage	-0.5	0	0.8	V

TRUTH TABLE

MODE	WE	CS ₁	CS ₂	OE	I/O OPERATION	V _{CC} CURRENT	NOTE
Not Selected (Power Down)	X	H	X	X	High-Z	I _{SB} , I _{SB1}	
	X	X	L	X	High-Z	I _{SB} , I _{SB2}	
Output Disabled	H	L	H	H	High-Z	I _{CC} , I _{CC1}	
Read	H	L	H	L	D _{OUT}	I _{CC} , I _{CC1}	
Write	L	L	H	H	D _{IN}	I _{CC} , I _{CC1}	Write Cycle 1
	L	L	H	L	D _{IN}	I _{CC} , I _{CC1}	Write Cycle 2

HY6264 8,192×8-Bit CMOS SRAM

T-46-23-12

DC CHARACTERISTICS

(V_{CC}=5V±10%, T_A=0°C to 70°C)

SYMBOL	PARAMETER	TEST CONDITIONS	HY6264			UNIT	
			MIN.	TYP. ⁽¹⁾	MAX.		
I _{LI}	Input Leakage Current	V _{IN} =GND to V _{CC}	-	-	2	μA	
I _{LO}	Output Leakage Current	$\overline{CS}_1 = V_{IH}$, CS ₂ =V _{IL} or OE=V _{IH} , V _{I/O} =GND to V _{CC}	-	-	2	μA	
I _{CC}	Operating Power Supply Current	$\overline{CS}_1 = V_{IL}$, CS ₂ =V _{IH} , I _{I/O} =0mA	-	30	50	mA	
I _{CC1}	Average Operating Current	Min. Duty Cycle=100%, CS ₁ =V _{IL} , CS ₂ =V _{IH}	-	40	70	mA	
I _{SB}	Standby Power Supply Current	CS ₁ =V _{IH} or CS ₂ =V _{IL}	-	1	3	mA	
I _{SB1} ⁽²⁾		$\overline{CS}_1 \geq V_{CC} - 0.2V$, CS ₂ < 0.2V or ≥ V _{CC} - 0.2V	L	-	20	2000	μA
I _{SB2} ⁽²⁾		$\overline{CS}_1 \leq 0.2V$ or ≥ V _{CC} - 0.2V, CS ₂ < 0.2V	L	-	2	100	μA
				-	20	2000	μA
V _{OL}	Output Low Voltage	I _{OL} =2.1mA	-	-	0.4	V	
V _{OH}	Output High Voltage	I _{OH} =-1.0mA	2.4	-	-	V	

NOTES:

1. Typical limits are at V_{CC}=5.0V, T_A=25°C and specified loading2. V_{IL} min=-0.5V

AC CHARACTERISTICS

(V_{CC}=5V±10%, T_A=0°C to 70°C)

READ CYCLE

SYMBOL	PARAMETER	HY6264-70		HY6264-85		HY6264-10		HY6264-12		HY6264-15		UNIT	
		MIN.	MAX.	MIN.	MAX.	MIN.	MAX.	MIN.	MAX.	MIN.	MAX.		
t _{RC}	Read Cycle Time	70	-	85	-	100	-	120	-	150	-	ns	
t _{AA}	Address Access Time	-	70	-	85	-	100	-	120	-	150	ns	
t _{ACS1}	Chip Select Access Time	\overline{CS}_1	-	70	-	85	-	100	-	120	-	150	ns
t _{ACS2}		CS ₂	-	70	-	85	-	100	-	120	-	150	ns
t _{OE}	Output Enable to Output Valid	-	45	-	50	-	55	-	60	-	70	ns	
t _{CLZ1}	Chip Select to Output in Low-Z	\overline{CS}_1	10	-	10	-	10	-	10	-	15	-	ns
t _{CLZ2}		CS ₂	10	-	10	-	10	-	10	-	15	-	ns
t _{OLZ}	Output Enable to Output in Low-Z	5	-	5	-	5	-	5	-	5	-	ns	
t _{CHZ1}	Chip Deselect to Output in High-Z	\overline{CS}_1	0	30	0	35	0	35	0	40	0	50	ns
t _{CHZ2}		CS ₂	0	30	0	35	0	35	0	40	0	50	ns
t _{OHZ}	Output Disable to Output in High-Z	0	30	0	35	0	35	0	40	0	50	ns	
t _{OH}	Output Hold from Address Change	10	-	10	-	10	-	10	-	15	-	ns	

HY6264 8,192×8-Bit CMOS SRAM

T-46-23-12

WRITE CYCLE

SYMBOL	PARAMETER	HY6264-70		HY6264-85		HY6264-10		HY6264-12		HY6264-15		UNIT	
		MIN.	MAX.	MIN.	MAX.	MIN.	MAX.	MIN.	MAX.	MIN.	MAX.		
t _{WC}	Write Cycle Time	70	—	85	—	100	—	120	—	150	—	ns	
t _{CSW}	Chip Select to End of Write	55	—	60	—	70	—	85	—	100	—	ns	
t _{AS}	Address Setup Time	0	—	0	—	0	—	0	—	0	—	ns	
t _{AW}	Address Valid to End of Write	60	—	70	—	80	—	85	—	100	—	ns	
t _{WP}	Write Pulse Width	50	—	55	—	60	—	70	—	90	—	ns	
t _{WR1}	Write Recovery Time	$\overline{CS}_1, \overline{WE}$	5	—	5	—	5	—	10	—	10	—	ns
t _{WR2}		CS ₂	5	—	10	—	10	—	15	—	15	—	ns
t _{WHZ}	Write to Output in High-Z	0	30	0	35	0	35	0	40	0	50	ns	
t _{DW}	Data to Write Time Overlap	30	—	35	—	40	—	50	—	60	—	ns	
t _{DH}	Data Hold from Write Time	0	—	0	—	0	—	0	—	0	—	ns	
t _{OHZ}	Output Enable to Output in High-Z	0	30	0	35	0	35	0	40	0	50	ns	
t _{OW}	Output Active from End of Write	5	—	5	—	5	—	5	—	10	—	ns	

AC TEST CONDITIONS

(T_A=0°C to 70°C)

Input Pulse Level	0.8V to 2.4V
Input Rise and Fall Time	5ns
Input and Output Timing Reference Level	1.5V

OUTPUT LOAD

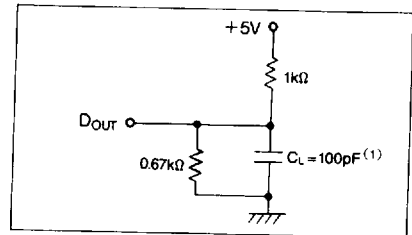

NOTE :
1. Including scope and the jig

CAPACITANCE⁽¹⁾

(T_A=25°C, f=1.0MHz)

SYMBOL	PARAMETER	CONDITIONS	MAX.	UNIT
C _{IN}	Input Capacitance	V _{IN} =0V	6	pF
C _{I/O}	Input/Output Capacitance	V _{I/O} =0V	8	pF

NOTE :

1. This parameter is sampled and not 100% tested.

TIMING DIAGRAMS

READ CYCLE 1^(1,2,4)

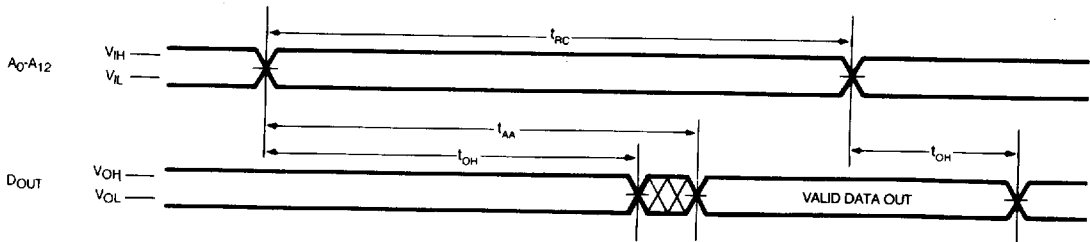

HY6264 8,192×8-Bit CMOS SRAM

T-46-23-12

READ CYCLE 2^(1,3,4,6)

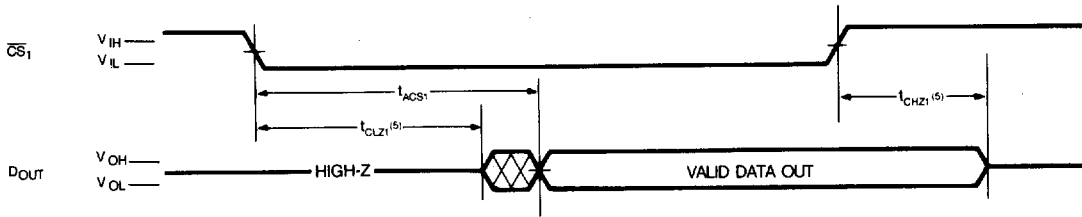

READ CYCLE 3^(1,4,7)

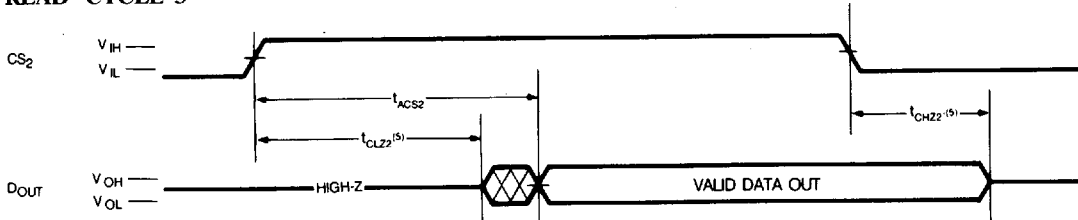

READ CYCLE 4^(1,2)

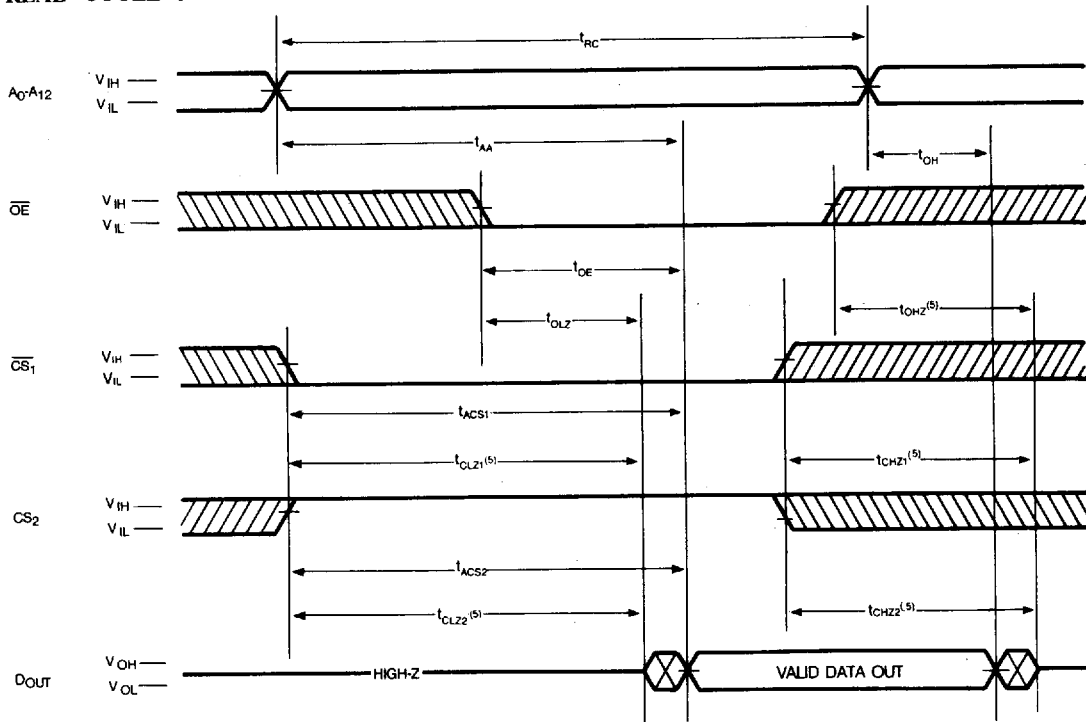

NOTES :

1. \overline{WE} is high for read cycle.
2. Device is continuously selected $\overline{CS1} = V_{IL}$ and $CS2 = V_{IH}$.
3. Addresses are valid prior to or coincident with $\overline{CS1}$ transition low.
4. $OE = V_{IL}$.
5. Transition is measured $\pm 500mV$ from steady state. This parameter is sampled and not 100% tested.
6. $CS2$ is high.
7. $CS1$ is low.

HY6264 8,192×8-Bit CMOS SRAM

T-46-23-12

WRITE CYCLE 1⁽¹⁾

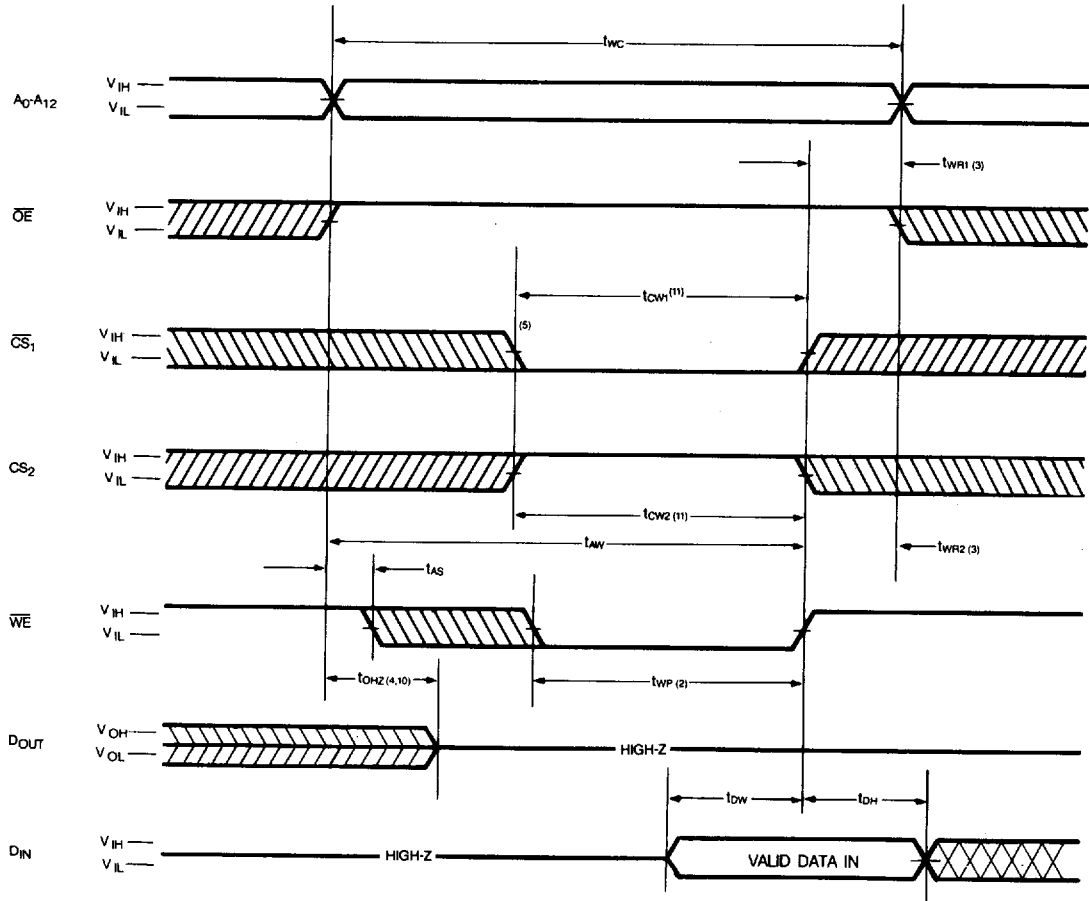

T-46-23-12

WRITE CYCLE 2^(1,6)

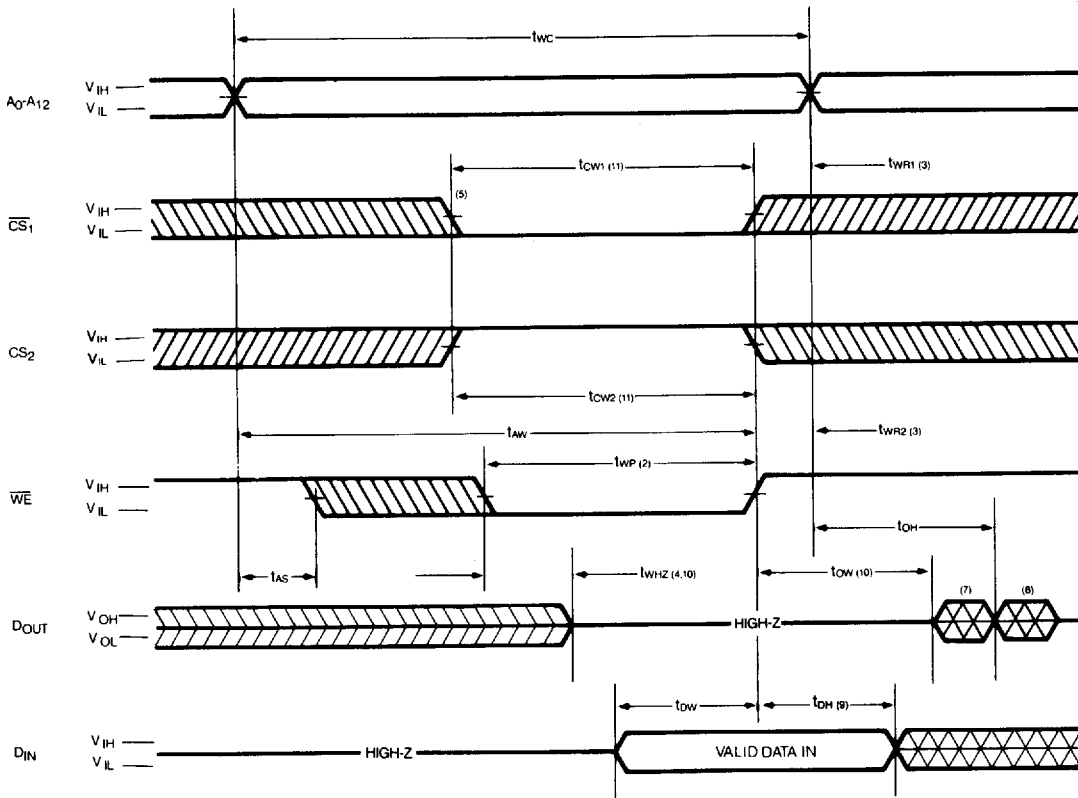

5

NOTES :

1. \overline{WE} must be high during address transitions.
2. A write occurs during the overlap (t_{WP}) of low \overline{CS}_1 , high CS_2 and low \overline{WE} .
3. t_{WR} is measured from the earlier of \overline{CS}_1 or \overline{WE} going high or CS_2 going low to the end of write cycle.
4. During this period, I/O pins are in output state so that the input signals of opposite phase to the output must not be applied.
5. If the \overline{CS}_1 low transition or the CS_2 high transition occurs simultaneously with the \overline{WE} low transition or after the \overline{WE} transition, outputs remain in a high impedance state.
6. \overline{OE} is continuously low ($\overline{OE} = V_{IL}$).
7. D_{OUT} is the same phase of write data of this write cycle.
8. D_{OUT} is the read data of next address.
9. If \overline{CS}_1 is low and CS_2 is high during this period, I/O pins are in the output state. Then the data input signals of opposite phase to the output must not be applied to them.
10. Transition is measured $\pm 500mV$ from steady state.
11. t_{CW} is measured from the later of \overline{CS}_1 going low or CS_2 going high to the end of write.

HY6264 8,192×8-Bit CMOS SRAM

T-46-23-12

DATA RETENTION CHARACTERISTICS⁽¹⁾
($T_A=0^{\circ}\text{C}$ to 70°C)

SYMBOL	PARAMETER	TEST CONDITIONS	MIN.	TYP. ⁽²⁾	MAX.	UNIT
V_{DR1}	Data Retention Supply Voltage	$\overline{CS}_1 \geq V_{CC}-0.2\text{V}$, $CS_2 \geq V_{CC}-0.2\text{V}$ or $CS_2 \leq 0.2\text{V}$	2.0	-	-	V
V_{DR2}		$CS_2 \leq 0.2\text{V}$, $\overline{CS}_1 \geq V_{CC}-0.2\text{V}$ or $\overline{CS}_1 \leq 0.2\text{V}$	2.0	-	-	V
I_{CCDR1}	Data Retention Current	$V_{CC}=3\text{V}$, $V_{IN}=0\text{V}$ to V_{CC} $\overline{CS}_1 \geq V_{CC}-0.2\text{V}$, $CS_2 \geq V_{CC}-0.2\text{V}$ or $CS_2 \leq 0.2\text{V}$	-	2	50	μA
I_{CCDR2}		$V_{CC}=3\text{V}$, $V_{IN}=0\text{V}$ to V_{CC} $CS_2 \leq 0.2\text{V}$, $\overline{CS}_1 \geq V_{CC}-0.2\text{V}$ or $\overline{CS}_1 \leq 0.2\text{V}$	-	2	50	μA
t_{CDR}	Chip Deselect to Data Retention Time	See Data Retention Timing Diagram	0	-	-	ns
t_R	Operation Recovery Time		t_{RC} ⁽³⁾	-	-	ns

NOTES :

1. These characteristics are guaranteed only for L-version
2. $T_A = 25^{\circ}\text{C}$
3. t_{RC} = Read Cycle Time

DATA RETENTION TIMING DIAGRAM 1 (\overline{CS}_1 Controlled)

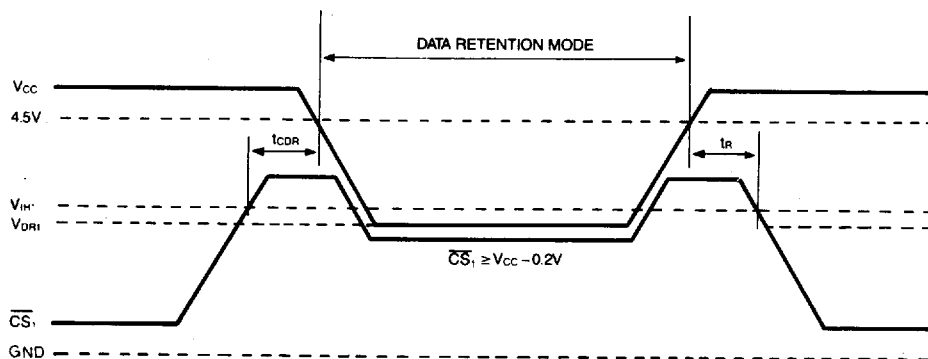

DATA RETENTION TIMING DIAGRAM 2 (\overline{CS}_2 Controlled)

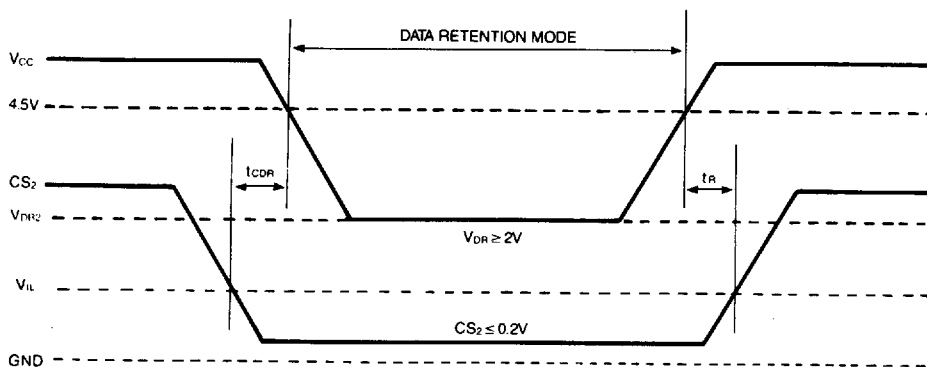

HY6264 8,192×8-Bit CMOS SRAM

T-46-23-12

ELECTRICAL CHARACTERISTIC CURVES

($V_{CC}=5V$, $T_A=25^\circ C$, unless otherwise noted)

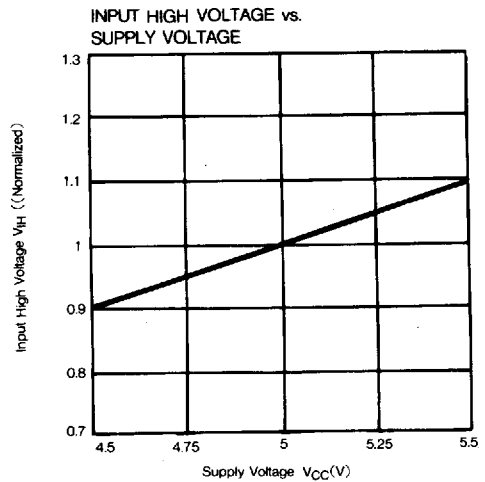
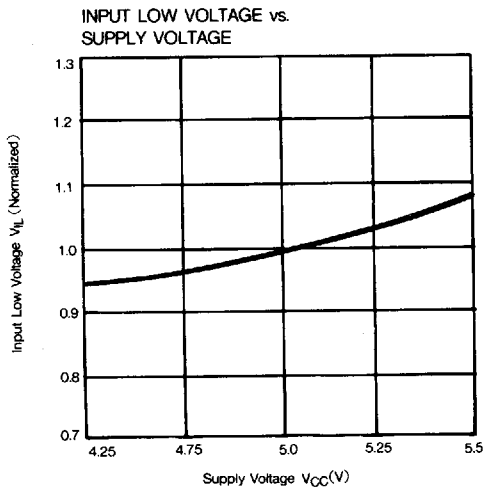
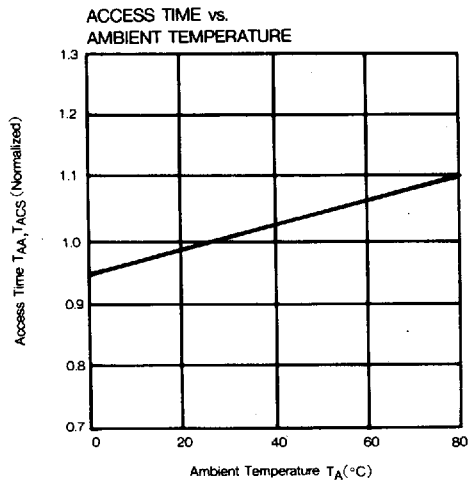
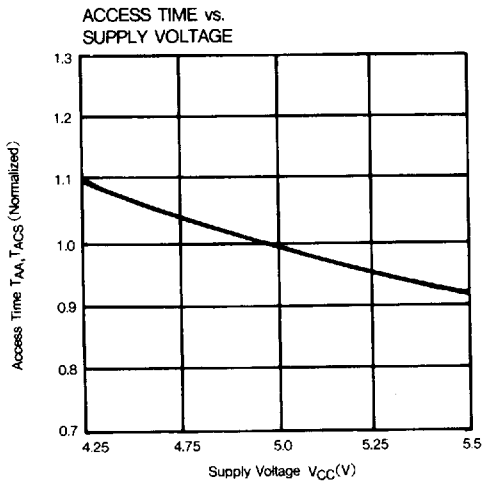
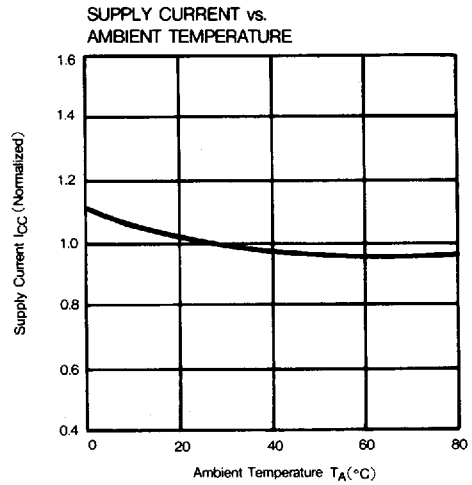
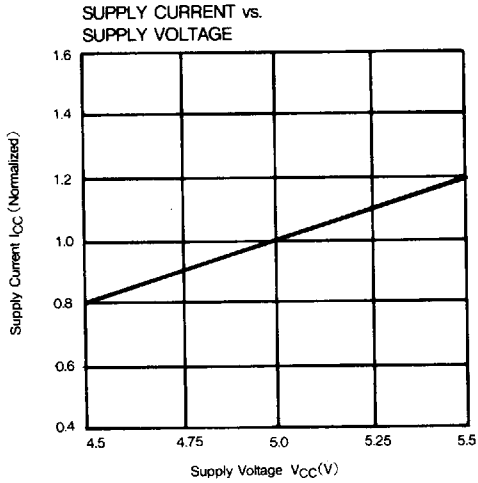

5

HY6264 8,192×8-Bit CMOS SRAM

T-46-23-12

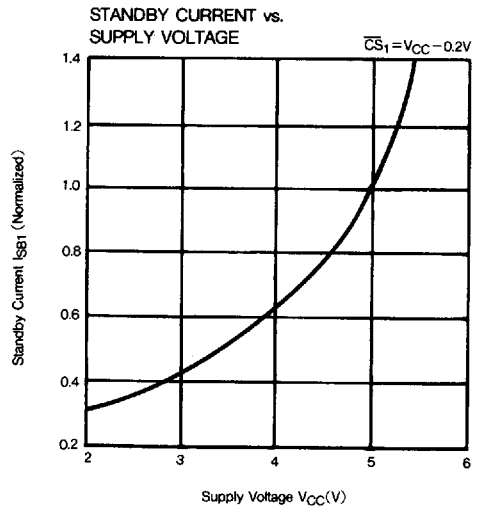
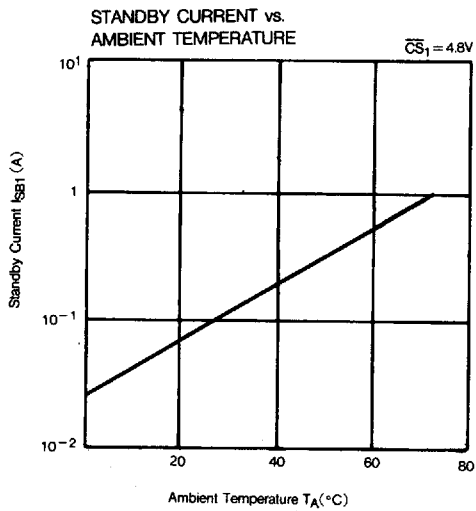
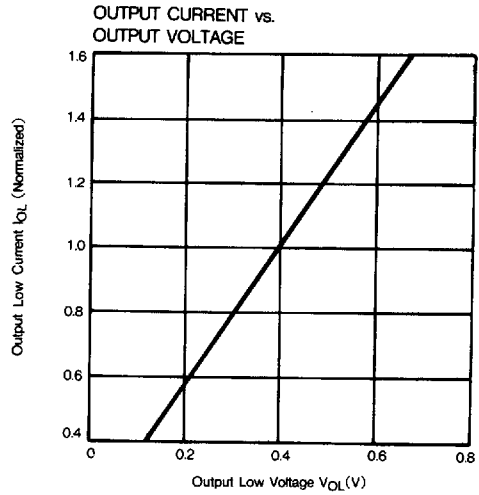
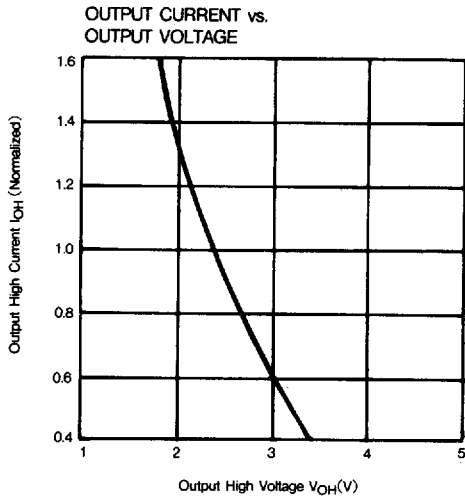

HY6264 8,192×8-Bit CMOS SRAM

T-46-23-12

PACKAGE INFORMATION

- 28 PIN PLASTIC DUAL IN LINE PACKAGE-600MIL

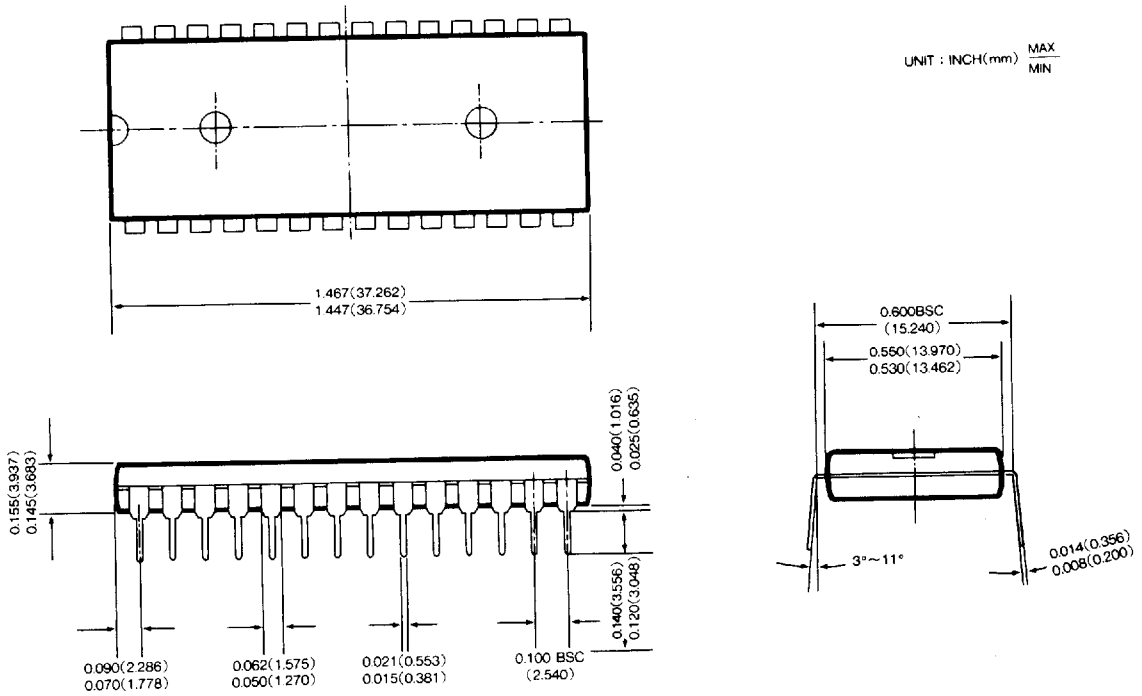

- 28 PIN SMALL OUTLINE PACKAGE-330MIL

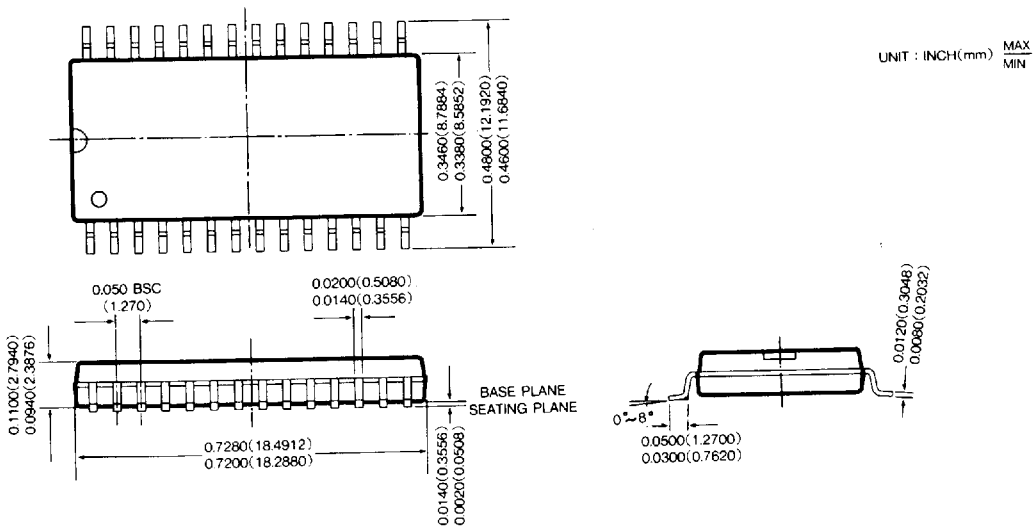



LittleDiode supplies new, hard to find or obsolete electronic components and semiconductors all over the world.

With over two million different components listed you are sure to find the part you need.

Feel free to visit us today at our online store:

LittleDiode.com

Looking forward to providing you with the best possible service.