

## Wideband, Fast Settling, Unity Gain Stable, Video Operational Amplifier

July 1994

### Features

- This Circuit is Processed in Accordance to MIL-STD-883 and is Fully Conformant Under the Provisions of Paragraph 1.2.1
- Low AC Variability Over Process and Temperature
- Low Supply Current. . . . . 11mA (Max)
- Unity Gain Bandwidth . . . . . 50MHz (Typ)
- High Slew Rate. . . . . 290V/ $\mu$ s (Typ)
- Low Offset Voltage. . . . . 1mV (Typ)
- Full Power Bandwidth . . . . . 4.6MHz (Typ)
- Low Differential Gain/Phase . . . . . 0.03%/0.03° (Typ)

### Applications

- Pulse and Video Amplifiers
- Wideband Amplifiers
- Fast Sample and Hold Circuits
- Fast, Precise D/A Converters
- High Speed A/D Input Buffer

### Description

The HA-2841/883 is a wideband, unity gain stable, operational amplifier featuring a 50MHz unity gain bandwidth, and excellent DC specifications. This amplifier's performance is further enhanced through stable operation down to closed loop gains of +1, the inclusion of offset null controls, and by its excellent video performance.

The capabilities of the HA-2841/883 are ideally suited for high speed pulse and video amplifier circuits, where high slew rates and wide bandwidth are required. Gain flatness of 0.05dB, combined with differential gain and phase specifications of 0.03%, and 0.03 degrees, respectively, make the HA-2841/883 ideal for component and composite video applications.

A zener/nichrome based reference circuit, coupled with advanced laser trimming techniques, yields a supply current with a low temperature coefficient and low lot-to-lot variability. Tighter  $I_{CC}$  control translates to more consistent AC parameters ensuring that units from each lot perform the same way, and easing the task of designing systems for wide temperature ranges.

### Ordering Information

PART NUMBER	TEMPERATURE RANGE	PACKAGE
HA1-2841/883	-55°C to +125°C	14 Lead CerDIP
HA7-2841/883	-55°C to +125°C	8 Lead CerDIP

### Pinouts

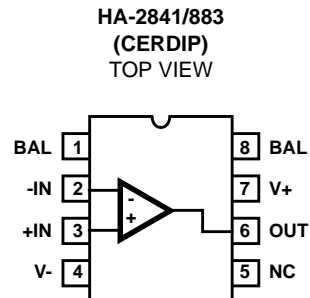
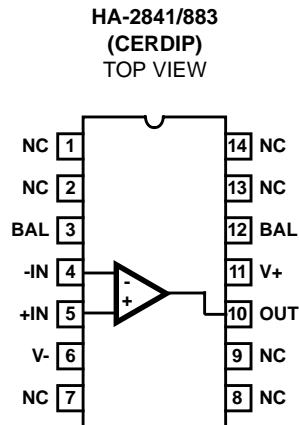

NOTE: (NC) No Connection pins may be tied to a ground plane for better isolation and heat dissipation.

# Specifications HA-2841/883

## Absolute Maximum Ratings

Voltage between V+ and V- Terminals . . . . .	+35V
Differential Input Voltage . . . . .	6V
Voltage at Either Input Terminal . . . . .	V+ to V-
Peak Output Current ( $\leq 10\%$ Duty Cycle) . . . . .	50mA
Junction Temperature ( $T_J$ ) . . . . .	+175°C
Storage Temperature Range . . . . .	-65°C to +150°C
ESD Rating . . . . .	<2000V
Lead Temperature (Soldering 10s) . . . . .	+300°C

## Thermal Information

Thermal Resistance	$\theta_{JA}$	$\theta_{JC}$
14 Pin CerDIP Package . . . . .	73°C/W	18°C/W
8 Pin CerDIP Package . . . . .	110°C/W	27°C/W
Package Power Dissipation Limit at +75°C for $T_J \leq +175^\circ\text{C}$		
14 Pin CerDIP Package . . . . .	1.05W	
8 Pin CerDIP Package . . . . .	0.9W	
Package Power Dissipation Derating Factor Above +75°C		
14 Pin CerDIP Package . . . . .	10.5mW/°C	
8 Pin CerDIP Package . . . . .	9mW/°C	

*CAUTION: Stresses above those listed in "Absolute Maximum Ratings" may cause permanent damage to the device. This is a stress only rating and operation of the device at these or any other conditions above those indicated in the operational sections of this specification is not implied.*

## Operating Conditions

Operating Temperature Range . . . . .	-55°C to +125°C	$V_{INCM} \leq 1/2(V+ - V-)$
Operating Supply Voltage . . . . .	$\pm 12\text{V}$ to $\pm 15\text{V}$	$R_L \geq 1\text{k}\Omega$

**TABLE 1. DC ELECTRICAL PERFORMANCE CHARACTERISTICS**

Device Tested at:  $V_{SUPPLY} = \pm 15\text{V}$ ,  $R_{SOURCE} = 100\Omega$ ,  $R_{LOAD} = 100\text{k}\Omega$ ,  $V_{OUT} = 0\text{V}$ , Unless Otherwise Specified.

PARAMETERS	SYMBOL	CONDITIONS	GROUP A SUBGROUP	TEMPERATURE	LIMITS		UNITS
					MIN	MAX	
Input Offset Voltage	$V_{IO}$	$V_{CM} = 0\text{V}$	1	+25°C	-4	4	mV
			2, 3	+125°C, -55°C	-8	8	mV
Input Bias Current	+ $I_B$	$V_{CM} = 0\text{V}$ , + $R_S = 1.1\text{k}\Omega$ - $R_S = 100\Omega$	1	+25°C	-10	10	$\mu\text{A}$
			2, 3	+125°C, -55°C	-20	20	$\mu\text{A}$
	- $I_B$	$V_{CM} = 0\text{V}$ , + $R_S = 100\Omega$ - $R_S = 1.1\text{k}\Omega$	1	+25°C	-10	10	$\mu\text{A}$
			2, 3	+125°C, -55°C	-20	20	$\mu\text{A}$
Input Offset Current	$I_{IO}$	$V_{CM} = 0\text{V}$ , + $R_S = 1.1\text{k}\Omega$ - $R_S = 1.1\text{k}\Omega$	1	+25°C	-1	1	$\mu\text{A}$
			2, 3	+125°C, -55°C	-2	2	$\mu\text{A}$
Common Mode Range	+CMR	$V+ = 5\text{V}$ $V- = -25\text{V}$	1	+25°C	10	-	V
			2, 3	+125°C, -55°C	10	-	V
	-CMR	$V+ = 25\text{V}$ $V- = -5\text{V}$	1	+25°C	-	-10	V
			2, 3	+125°C, -55°C	-	-10	V
Large Signal Voltage Gain	+ $A_{VOL}$	$V_{OUT} = 0\text{V}$ and +10V $R_L = 1\text{k}\Omega$	4	+25°C	10	-	kV/V
			5, 6	+125°C, -55°C	5	-	kV/V
	- $A_{VOL}$	$V_{OUT} = 0\text{V}$ and -10V $R_L = 1\text{k}\Omega$	4	+25°C	10	-	kV/V
			5, 6	+125°C, -55°C	5	-	kV/V
Common Mode Rejection Ratio	+CMRR	$\Delta V_{CM} = 10\text{V}$ , $V_{OUT} = -10\text{V}$ $V+ = 5\text{V}$ , $V- = -25\text{V}$	1	+25°C	86	-	dB
			2, 3	+125°C, -55°C	80	-	dB
	-CMRR	$\Delta V_{CM} = -10\text{V}$ , $V_{OUT} = 10\text{V}$ $V+ = 25\text{V}$ , $V- = -5\text{V}$	1	+25°C	86	-	dB
			2, 3	+125°C, -55°C	80	-	dB

## Specifications HA-2841/883

**TABLE 1. DC ELECTRICAL PERFORMANCE CHARACTERISTICS (Continued)**

Device Tested at:  $V_{SUPPLY} = \pm 15V$ ,  $R_{SOURCE} = 100\Omega$ ,  $R_{LOAD} = 100k\Omega$ ,  $V_{OUT} = 0V$ , Unless Otherwise Specified.

PARAMETERS	SYMBOL	CONDITIONS	GROUP A SUBGROUP	TEMPERATURE	LIMITS		UNITS
					MIN	MAX	
Output Voltage Swing	+V <sub>OUT</sub>	R <sub>L</sub> = 1kΩ	1	+25°C	10	-	V
			2, 3	+125°C, -55°C	10	-	V
	-V <sub>OUT</sub>	R <sub>L</sub> = 1kΩ	1	+25°C	-	-10	V
			2, 3	+125°C, -55°C	-	-10	V
Output Current	+I <sub>OUT</sub>	V <sub>OUT</sub> = -5V, (Note 1)	1	+25°C	25	-	mA
			2, 3	+125°C, -55°C	15	-	mA
	-I <sub>OUT</sub>	V <sub>OUT</sub> = 5V, (Note 1)	1	+25°C	-	-25	mA
			2, 3	+125°C, -55°C	-	-15	mA
Quiescent Power Supply Current	+I <sub>CC</sub>	V <sub>OUT</sub> = 0V I <sub>OUT</sub> = 0mA	1	+25°C	-	11	mA
			2, 3	+125°C, -55°C	-	11	mA
	-I <sub>CC</sub>	V <sub>OUT</sub> = 0V I <sub>OUT</sub> = 0mA	1	+25°C	-11	-	mA
			2, 3	+125°C, -55°C	-11	-	mA
Power Supply Rejection Ratio	+PSRR	$\Delta V_{SUPPLY} = 10V$ V+ = 10V, V- = -15V V+ = 20V, V- = -15V	1	+25°C	70	-	dB
			2, 3	+125°C, -55°C	70	-	dB
	-PSRR	$\Delta V_{SUPPLY} = 10V$ V+ = 15V, V- = -10V V+ = 15V, V- = -20V	1	+25°C	70	-	dB
			2, 3	+125°C, -55°C	70	-	dB
Offset Voltage Adjustment	+V <sub>IOAdj</sub>	(Note 2)	1	+25°C	V <sub>IO-1</sub>	-	mV
	-V <sub>IOAdj</sub>	(Note 2)	1	+25°C	V <sub>IO+1</sub>	-	mV

**NOTES:**

1. The output metal is sized to handle I<sub>OUT</sub> = 10mA at a 50% duty cycle, for T<sub>J</sub> = +175°C. For I<sub>OUT</sub> = 15mA and T<sub>J</sub> = +175°C, a duty cycle ≤33% is required.
2. Offset Adjustment range is |V<sub>IO</sub> (measured) ±1mV| minimum referred to output. This test is for functionality only, to assure adjustment through 0V.

**TABLE 2. AC ELECTRICAL PERFORMANCE CHARACTERISTICS**

Table 2 Intentionally Left Blank. See A.C. Specifications in Table 3

## Specifications HA-2841/883

**TABLE 3. ELECTRICAL PERFORMANCE CHARACTERISTICS**

Device Characterized at:  $V_{SUPPLY} = \pm 15V$ ,  $R_{SOURCE} = 50\Omega$ ,  $R_{LOAD} = 1k\Omega$ ,  $V_{OUT} = 0V$ ,  $A_V = +1V/V$ , Unless Otherwise Specified.

PARAMETERS	SYMBOL	CONDITIONS	NOTES	TEMPERATURE	LIMITS		UNITS
					MIN	MAX	
Gain Bandwidth Product	GBWP	$V_O = 200mV$ , $f_O = 0.1MHz$	1	+25°C	42	-	MHz
		$V_O = 200mV$ , $f_O = 10MHz$	1	+25°C	44	-	MHz
Slew Rate	SR	$V_O = -3V$ to +3V	1, 3	+25°C	200	-	V/ $\mu$ s
	SR	$V_O = -3V$ to +3V	1, 3	-55°C to +125°C	187	-	V/ $\mu$ s
Rise Time	$T_R$	$V_O = 0V$ to +200mV $C_L < 10pF$	1, 3	+25°C	-	6	ns
			1, 3	-55°C to +125°C	-	6	ns
Fall Time	$T_F$	$V_O = 0V$ to -200mV $C_L < 10pF$	1, 3	+25°C	-	5	ns
			1, 3	-55°C to +125°C	-	6	ns
Full Power Bandwidth	FPBW	$V_{PEAK} = +10V$	1, 2	+25°C	3.1	-	MHz
			1, 2	-55°C to +125°C	3.0	-	MHz
Overshoot	+OS	$V_O = 0V$ to +200mV	1	+25°C	-	60	%
			1	-55°C to +125°C	-	65	%
	-OS	$V_O = 0V$ to -200mV	1	+25°C	-	60	%
			1	-55°C to +125°C	-	70	%
Closed Loop Output Resistance	$R_{OUT}$	$A_V > +1$ $V_M = 10V$ , $\Delta I = 9mA$	1	+25°C	-	1	$\Omega$

**NOTES:**

- Parameters listed in Table 3 are controlled via design or process parameters and are not directly tested at final production. These parameters are lab characterized upon initial design release, or upon design changes. These parameters are guaranteed by characterization based upon data from multiple production runs which reflect lot to lot and within lot variations.
- Full Power Bandwidth guarantee based on Slew Rate measurement using  $FPBW = \text{Slew Rate} / (2\pi V_{PEAK})$ .
- Measured between 10% and 90% points.

**TABLE 4. ELECTRICAL TEST REQUIREMENTS**

MIL-STD-883 TEST REQUIREMENTS	SUBGROUPS (SEE TABLE 1)
Interim Electrical Parameters (Pre Burn-In)	1
Final Electrical Test Parameters	1 (Note 1), 2, 3, 4, 5, 6
Group A Test Requirements	1, 2, 3, 4, 5, 6
Groups C & D Endpoints	1

**NOTE:**

- PDA applies to Subgroup 1 only.

**Die Characteristics**

**DIE DIMENSIONS:**

77 x 81 x 19 mils  $\pm$  1 mils  
 1960 x 2060 x 483 $\mu$ m  $\pm$  25.4 $\mu$ m

**METALLIZATION:**

Type: Al, 1% Cu  
 Thickness: 16k $\text{\AA}$   $\pm$  2k $\text{\AA}$

**GLASSIVATION:**

Type: Nitride over Silox  
 Silox Thickness: 12k $\text{\AA}$   $\pm$  2k $\text{\AA}$   
 Nitride thickness: 3.5k $\text{\AA}$   $\pm$  1k $\text{\AA}$

**WORST CASE CURRENT DENSITY:**

1.2 x 10<sup>5</sup> A/cm<sup>2</sup> at 9.7mA

**SUBSTRATE POTENTIAL (Powered Up):** V-

**TRANSISTOR COUNT:** 43

**PROCESS:** Bipolar Dielectric Isolation

**Metallization Mask Layout**

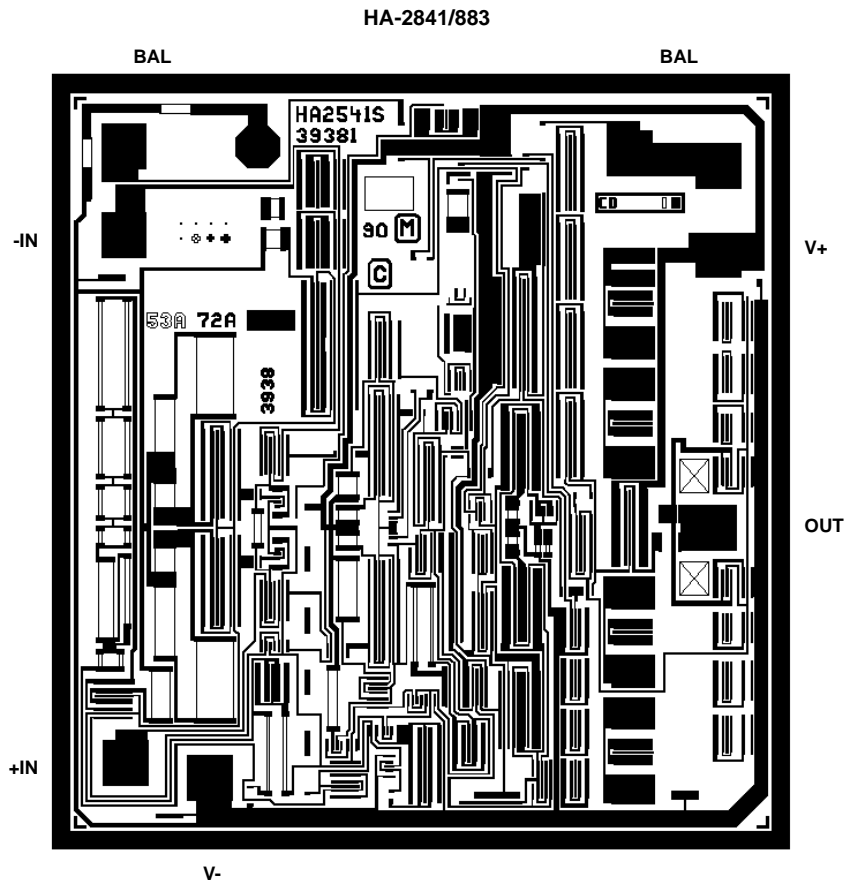

**Test Circuit** (Applies to Table 1)

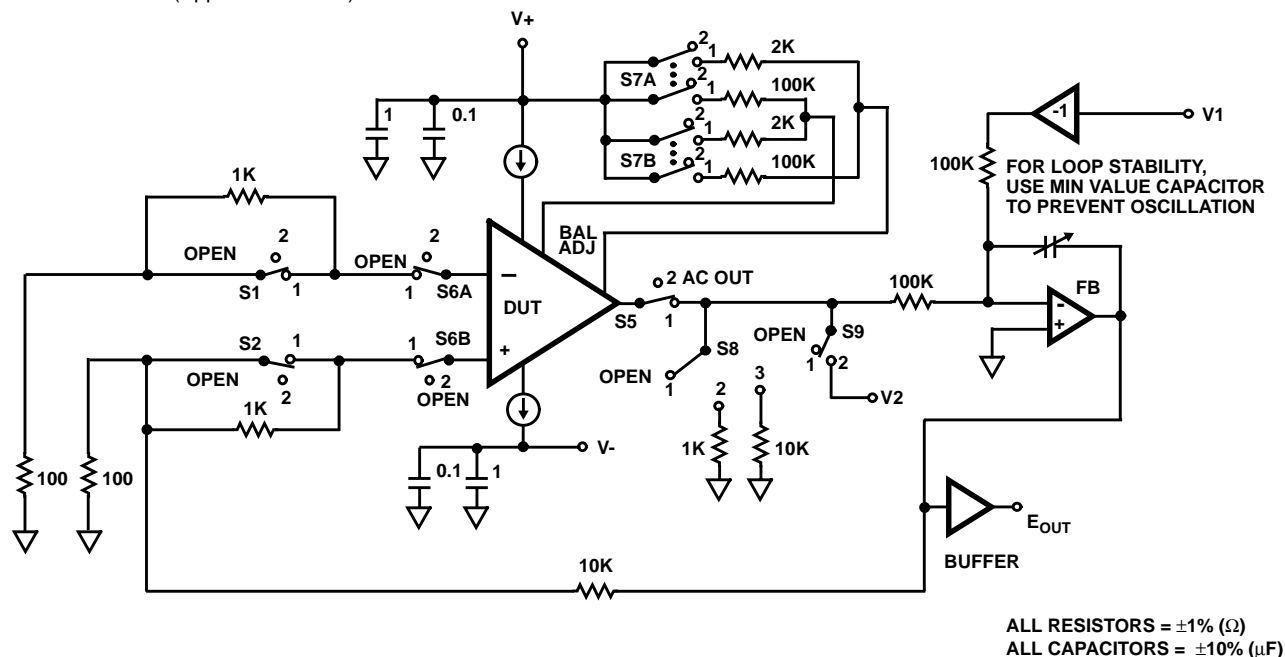

**Test Waveforms**

**SIMPLIFIED TEST CIRCUIT FOR LARGE AND SMALL SIGNAL RESPONSE** (Applies to Table 3)

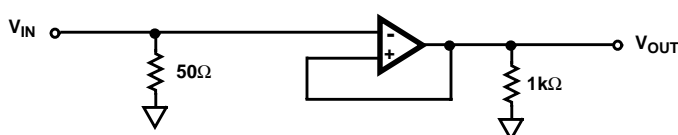

$V_S = \pm 15V$   
 $A_V = +1$   
 $C_L \leq 10pF$   
 NOTE: No Capacitive Load,  
 Maintain Parasitics  
 Less Than 10pF.

**MEASURED LARGE SIGNAL RESPONSE**

Vertical Scale: Input = 5V/Div., Output = 5V/Div.  
 Horizontal Scale: 50ns/Div.

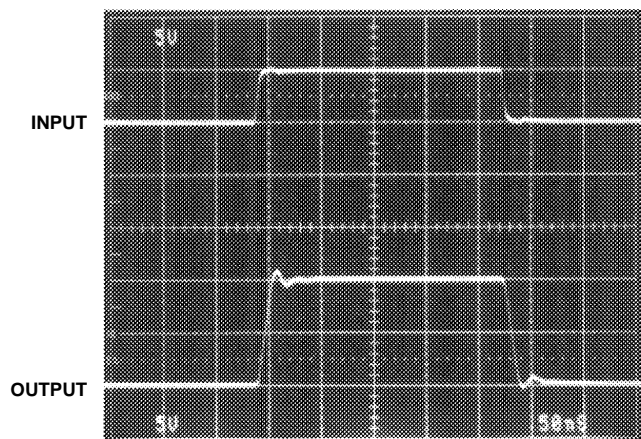

**MEASURED SMALL SIGNAL RESPONSE**

Vertical Scale: Input = 100mV/Div., Output = 100mV/Div.  
 Horizontal Scale: 50ns/Div.

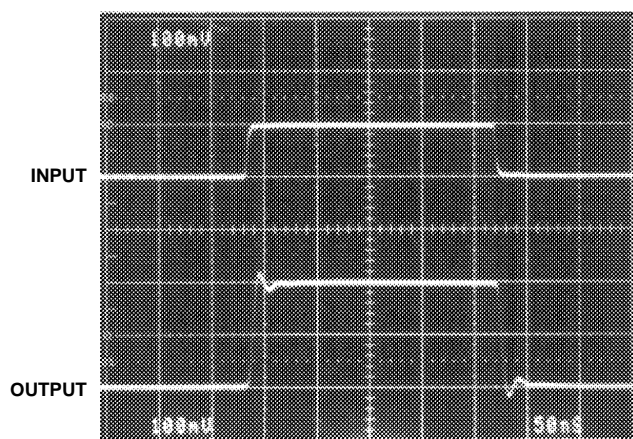

**Burn-In Circuits**

HA1-2841/883 CERAMIC DIP

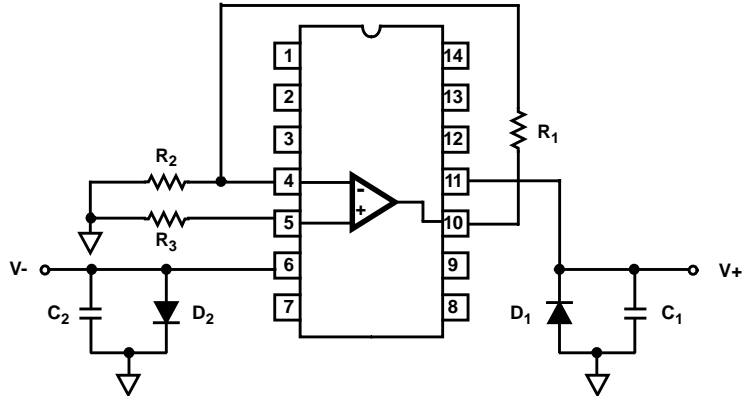

HA7-2841/883 CERAMIC DIP

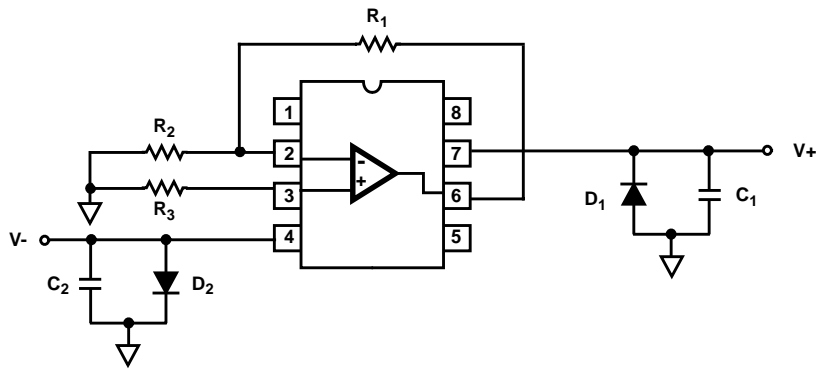

NOTES:

1.  $R_1 = 1M\Omega, \pm 5\%, 1/4W$  (Min)
2.  $R_2 = 100k\Omega, \pm 5\%, 1/4W$  (Min),  $= R_3$
3.  $C_1 = C_2 = 0.01\mu F/\text{Socket}$  (Min) or  $0.1\mu F/\text{Row}$ , (Min)
4.  $D_1 = D_2 = 1N4002$  or Equivalent/Board
5.  $|V_+ - V_-| = 31V \pm 1V$

Schematic Diagram

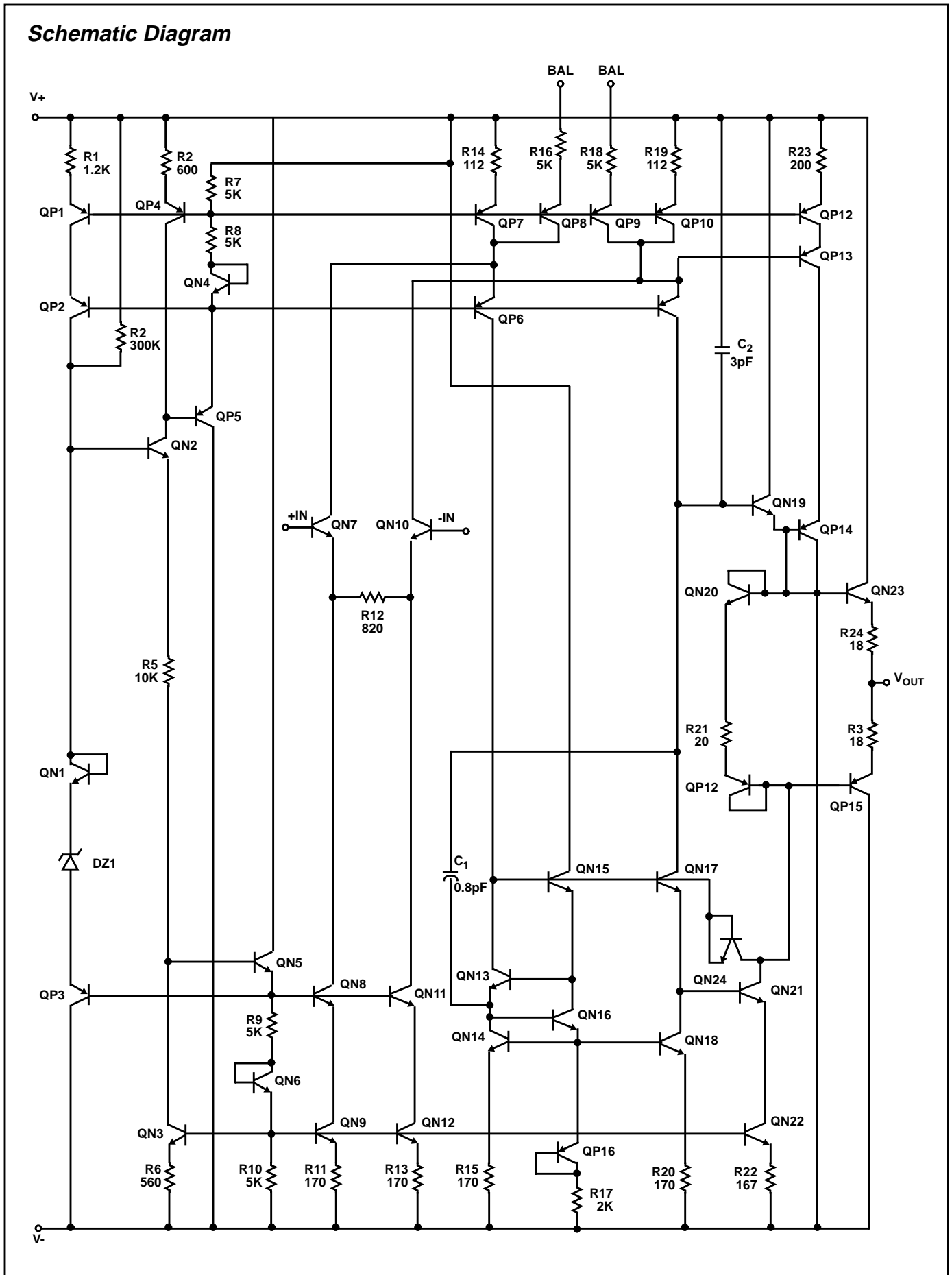

## DESIGN INFORMATION

## Wideband, Fast Settling, Unity Gain Stable, Video Operational Amplifier

The information contained in this section has been developed through characterization by Intersil Corporation and is for use as application and design information only. No guarantee is implied.

**Typical Performance Curves**  $V_{SUPPLY} = \pm 15V$ ,  $A_V = +1$ ,  $R_L = 1k\Omega$ ,  $C_L \leq 10pF$ ,  $T_A = +25^\circ C$ , Unless Otherwise Specified.

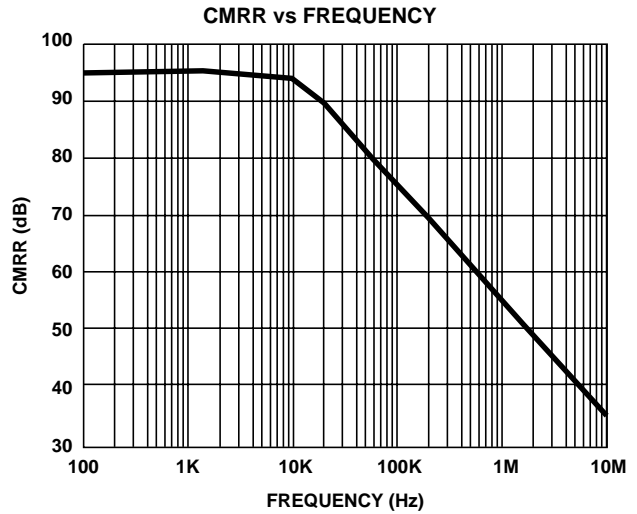
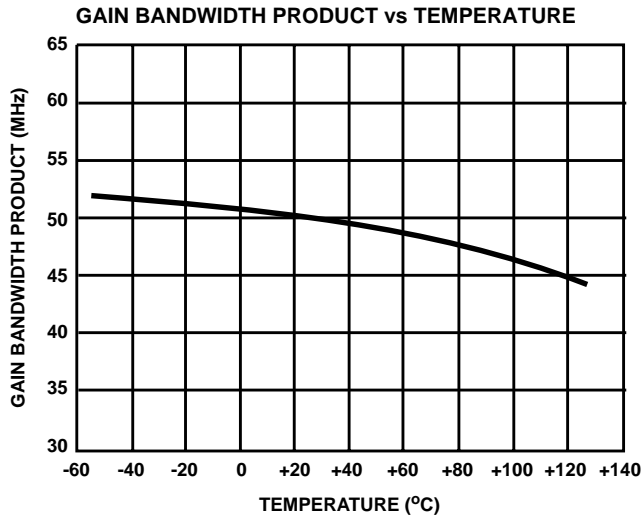
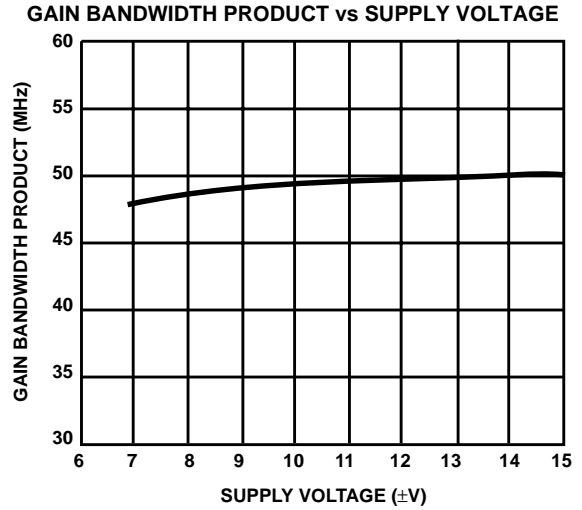
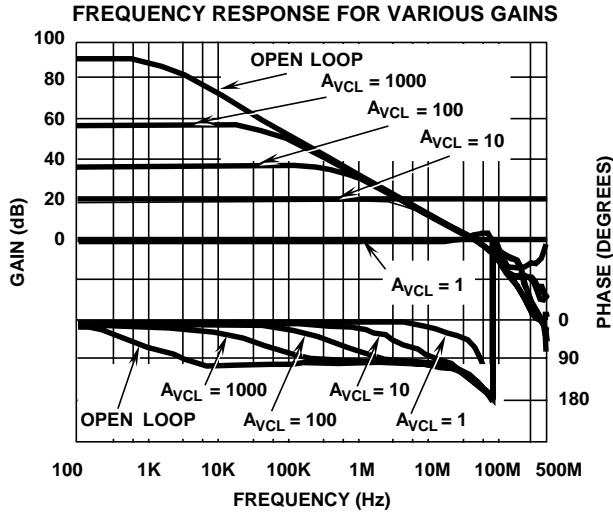

## DESIGN INFORMATION (Continued)

The information contained in this section has been developed through characterization by Intersil Corporation and is for use as application and design information only. No guarantee is implied.

**Typical Performance Curves**  $V_{SUPPLY} = \pm 15V$ ,  $A_V = +1$ ,  $R_L = 1k\Omega$ ,  $C_L \leq 10pF$ ,  $T_A = +25^\circ C$ , Unless Otherwise Specified.

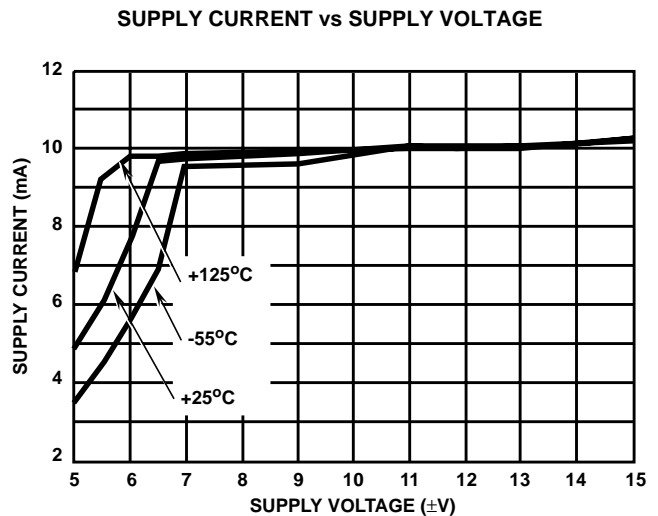
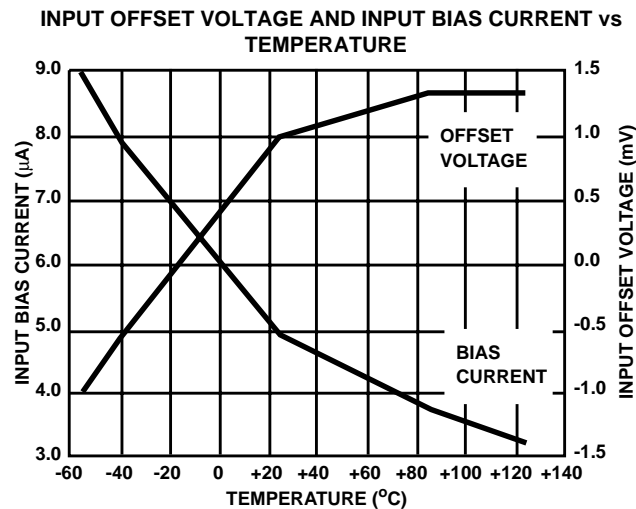
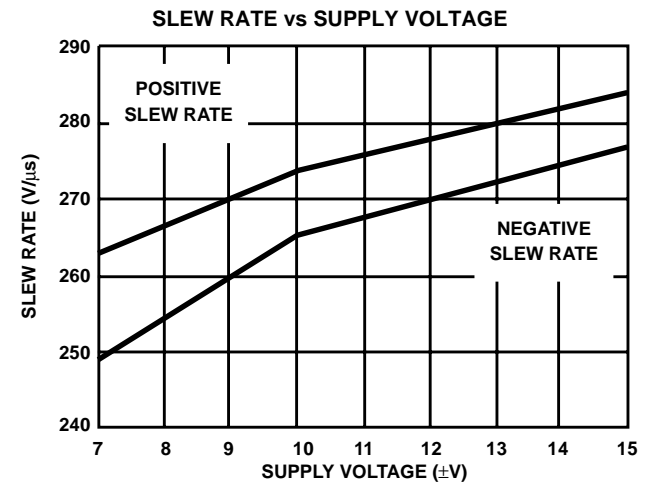
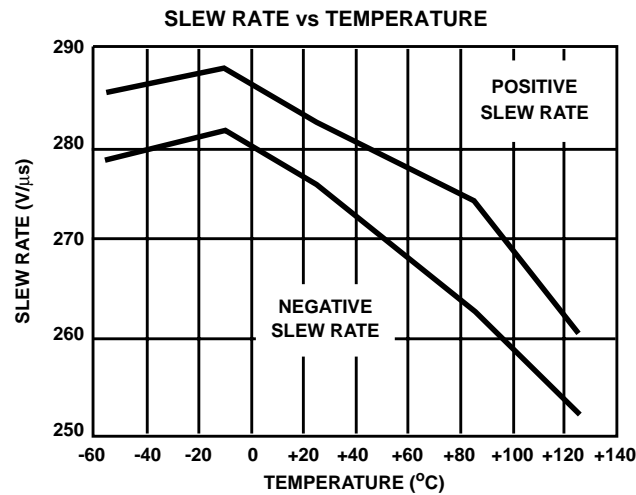
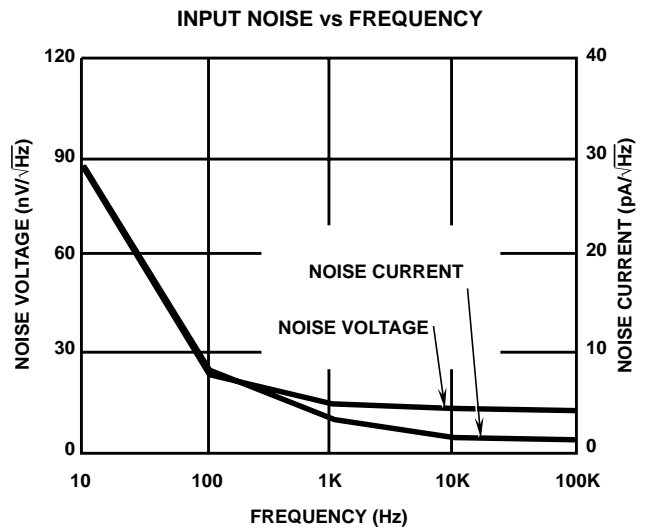
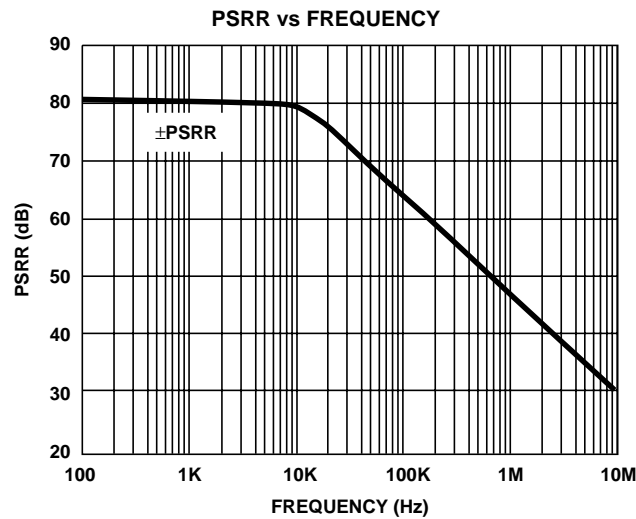

# DESIGN INFORMATION (Continued)

The information contained in this section has been developed through characterization by Intersil Corporation and is for use as application and design information only. No guarantee is implied.

**Typical Performance Curves**  $V_{SUPPLY} = \pm 15V$ ,  $A_V = +1$ ,  $R_L = 1k\Omega$ ,  $C_L \leq 10pF$ ,  $T_A = +25^\circ C$ , Unless Otherwise Specified.

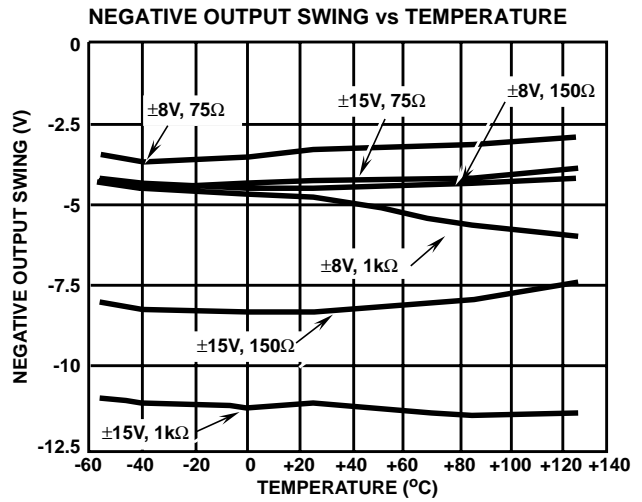
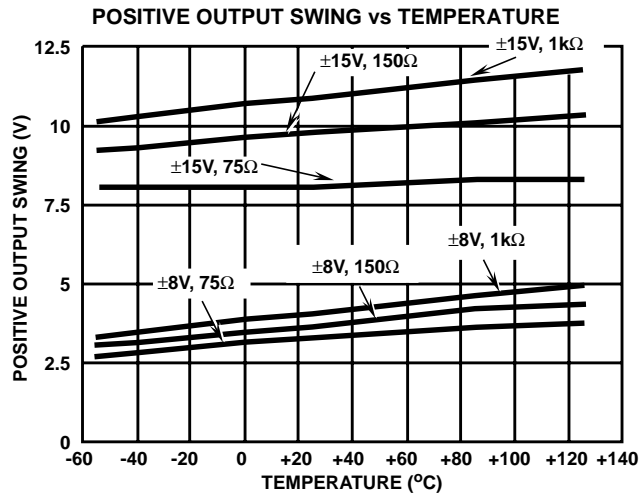

MAXIMUM UNDISTORTED OUTPUT SWING vs FREQUENCY

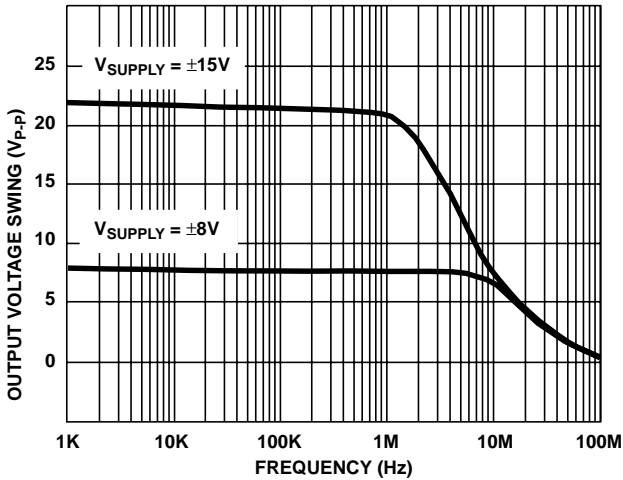

TOTAL HARMONIC DISTORTION vs FREQUENCY

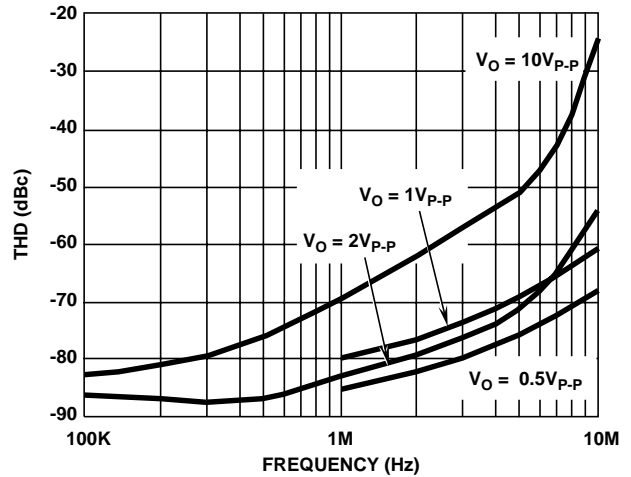

INTERMODULATION DISTORTION vs FREQUENCY (TWO TONE)

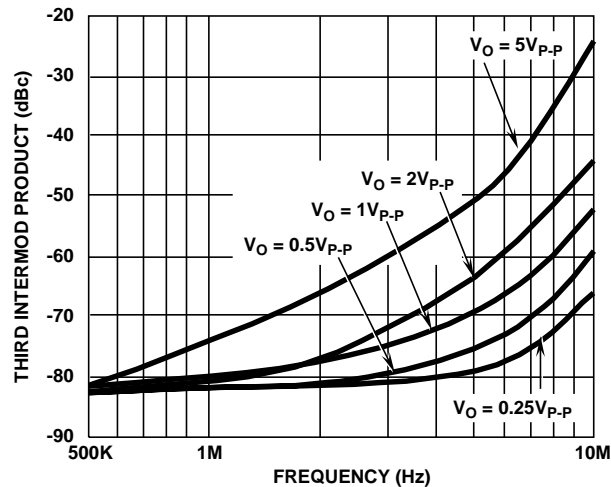

DIFFERENTIAL GAIN vs LOAD RESISTANCE

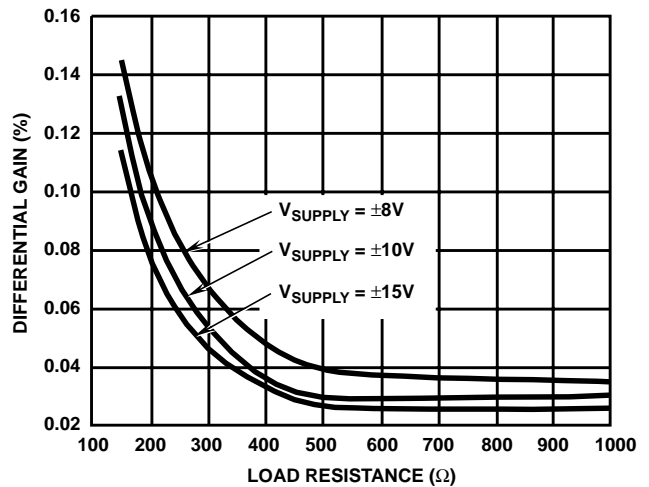

## DESIGN INFORMATION (Continued)

The information contained in this section has been developed through characterization by Intersil Corporation and is for use as application and design information only. No guarantee is implied.

**Typical Performance Curves**  $V_{SUPPLY} = \pm 15V$ ,  $A_{VCL} = +1$ ,  $R_L = 1k\Omega$ ,  $C_L \leq 10pF$ ,  $T_A = +25^\circ C$ , Unless Otherwise Specified.

DIFFERENTIAL PHASE vs LOAD RESISTANCE

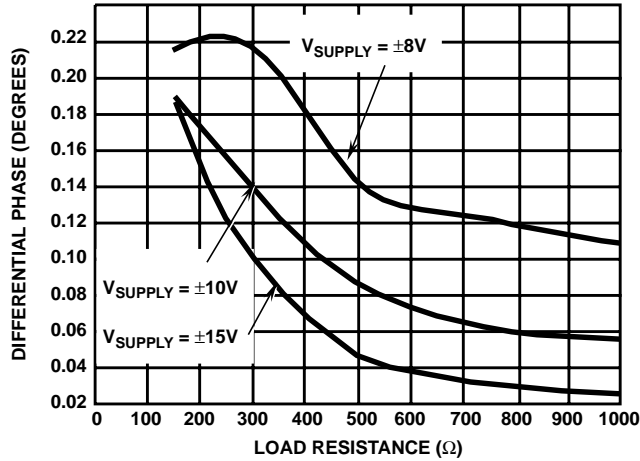

GAIN FLATNESS vs FREQUENCY

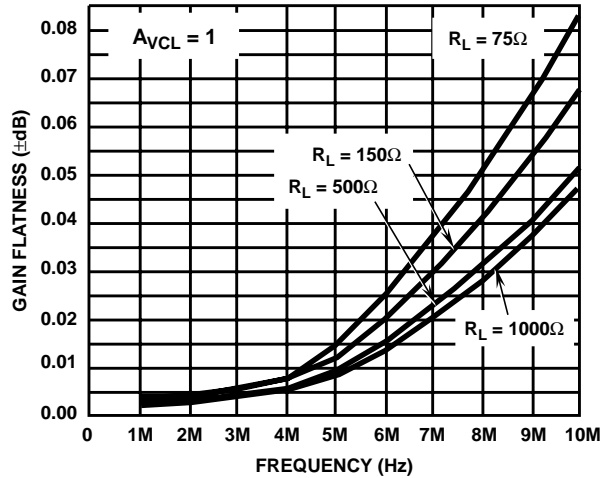

### Suggested Offset Voltage Adjustment

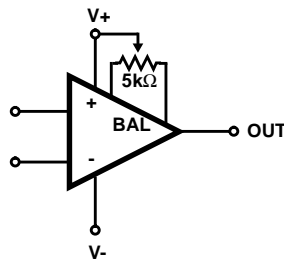

## HA-2841

### TYPICAL PERFORMANCE CHARACTERISTICS

Device Characterized at:  $V_{SUPPLY} = \pm 15V$ ,  $R_L = 1k\Omega$ ,  $C_L \leq 10pF$ , Unless Otherwise Specified.

PARAMETERS	CONDITIONS	TEMPERATURE	TYPICAL	UNITS
Input Offset Voltage	$V_{CM} = 0V$	+25°C	1	mV
Average Offset Voltage Drift	Versus Temperature	Full	14	$\mu V/^\circ C$
Input Bias Current	$V_{CM} = 0V$	+25°C	5.0	$\mu A$
		Full	8.0	$\mu A$
Input Offset Current	$V_{CM} = 0V$	+25°C	0.5	$\mu A$
Differential Input Resistance		+25°C	170	k $\Omega$
Input Noise Voltage	$f_O = 10Hz$ to 1MHz	+25°C	16	$\mu V_{RMS}$
Input Noise Voltage Density	$f_O = 1000Hz$	+25°C	16	$nV/\sqrt{Hz}$
Input Noise Current Density	$f_O = 1000Hz$	+25°C	2	$pA/\sqrt{Hz}$
Large Signal Voltage Gain	$V_{OUT} = \pm 10V$	+25°C	50	kV/V
		Full	30	kV/V
CMRR	$V_{CM} = \pm 2V$	Full	95	dB
Gain Bandwidth Product	$f = 10MHz$	+25°C	50	MHz
Output Voltage Swing		Full	$\pm 10.5$	V
Output Current	$V_{OUT} > 10V$	Full	30	mA
Output Resistance	Open Loop	+25°C	8.5	$\Omega$
Full Power Bandwidth	$FPBW = SR/2\pi V_P$ , $V_P = 10V$	+25°C	4.6	MHz
Slew Rate	$V_{OUT} = \pm 5V$ , $A_V = +2$	+25°C	290	V/ $\mu s$
Rise Time	$V_{OUT} = \pm 100mV$ , $A_V = +2$	+25°C	3.5	ns
Overshoot	$V_{OUT} = \pm 100mV$ , $A_V = +2$	+25°C	47	%
Settling Time	0.1%, 10V Step, $A_V = +2$	+25°C	145	ns
PSRR	Delta $V_S = \pm 10V$ to $\pm 20V$	Full	80	dB
Supply Current	No Load	Full	10	mA
Differential Gain	$R_L = 700\Omega$	+25°C	0.03	%
Differential Phase	$R_L = 700\Omega$	+25°C	0.03	Degrees
Gain Flatness to 5MHz	$R_L = 75\Omega$	+25°C	$\pm 0.015$	dB
Gain Flatness to 10MHz	$R_L = 75\Omega$	+25°C	$\pm 0.05$	dB

All Intersil semiconductor products are manufactured, assembled and tested under **ISO9000** quality systems certification.

*Intersil products are sold by description only. Intersil Corporation reserves the right to make changes in circuit design and/or specifications at any time without notice. Accordingly, the reader is cautioned to verify that data sheets are current before placing orders. Information furnished by Intersil is believed to be accurate and reliable. However, no responsibility is assumed by Intersil or its subsidiaries for its use; nor for any infringements of patents or other rights of third parties which may result from its use. No license is granted by implication or otherwise under any patent or patent rights of Intersil or its subsidiaries.*

For information regarding Intersil Corporation and its products, see web site <http://www.intersil.com>

This datasheet has been downloaded from:

[www.DatasheetCatalog.com](http://www.DatasheetCatalog.com)

Datasheets for electronic components.



LittleDiode supplies new, hard to find or obsolete electronic components and semiconductors all over the world.

With over two million different components listed you are sure to find the part you need.

Feel free to visit us today at our online store:

[LittleDiode.com](http://LittleDiode.com)

Looking forward to providing you with the best possible service.