

GL8□□4 series

2.0 × 3.1mm, Arch Type, Colored Transparency, High-luminosity LED Lamp for Indicator

Outline Dimensions

(Unit : mm)

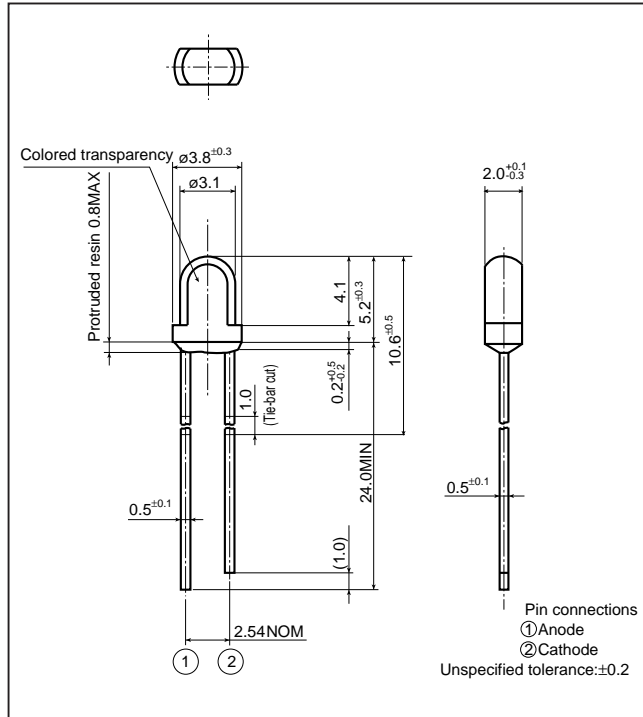

Absolute Maximum Ratings

($T_a=25^\circ\text{C}$)

Model No.	Radiation color	Radiation material	Power dissipation P (mW)	Forward current I_F (mA)	Peak forward current I_{FM} (mA)	Derating factor (mA/ $^\circ\text{C}$)		Reverse voltage V_R (V)	Operating temperature T_{opr} ($^\circ\text{C}$)	Storage temperature T_{stg} ($^\circ\text{C}$)	Soldering temperature T_{sol} ^{*3} ($^\circ\text{C}$)
						DC	Pulse				
GL8UR4	Red(Super-luminosity)	GaAlAs on GaAlAs	75	30	50 ^{*1}	0.40	0.67	4	-25 to +85	-25 to +100	260
GL8TR4	Red(High-luminosity)	GaAlAs on GaAs	110	50	300 ^{*2}	0.67	4.00	5	-25 to +85	-25 to +100	260

*1 Duty ratio=1/10, Pulse width=0.1ms

*2 Duty ratio=1/16, Pulse width \leq 1ms

*3 5s or less(At the position of 1.6mm or more from the bottom face of resin package)

Electro-optical Characteristics

($T_a=25^\circ\text{C}$)

Lens type	Model No.	Forward voltage V_F (V)		Peak emission wavelength λ_p (nm)		Luminous intensity		Spectrum radiation bandwidth $\Delta\lambda$ (nm)		Reverse current		Terminal capacitance		Page for characteristics diagrams
		TYP	MAX	TYP	I_F (mA)	I_v (mcd)	I_F (mA)	TYP	I_F (mA)	I_R (μA)	V_R (V)	C_t (pF)	(MHz)	
Colored transparency	GL8UR4	1.85	2.5	660	20	150	20	20	20	100	3	25	1	→
	GL8TR4	1.75	2.2	660	20	40	20	20	20	10	4	30	1	→

(Notice) • In the absence of confirmation by device specification sheets, SHARP takes no responsibility for any defects that may occur in equipment using any SHARP devices shown in catalogs, data books, etc. Contact SHARP in order to obtain the latest device specification sheets before using any SHARP device.

(Internet) • Data for sharp's optoelectronic/power device is provided for internet.(Address <http://www.sharp.co.jp/ecg/>)

LED Lamp Characteristics Diagrams

UR series

Forward Current Derating Curve

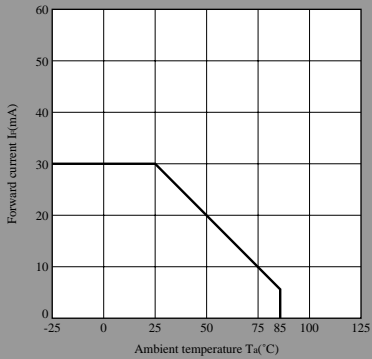

Forward Current vs. Forward Voltage(Note)

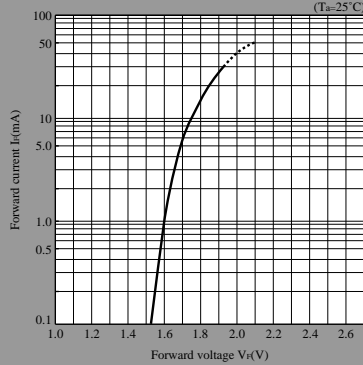

Luminous Intensity vs. Ambient Temperature(Note)

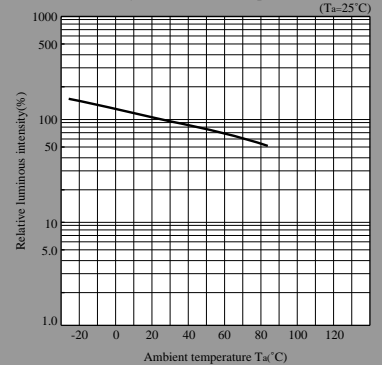

Peak Forward Current Derating Curve

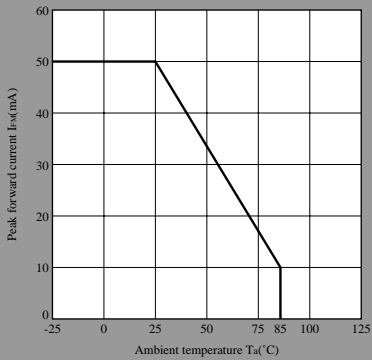

Luminous Intensity vs. Forward Current(Note)

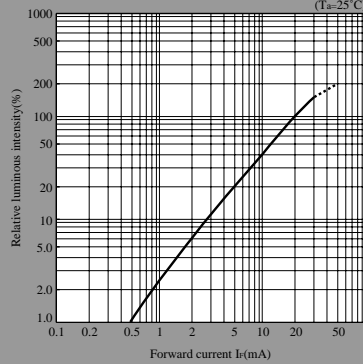

Duty Ratio vs. Peak Forward Current

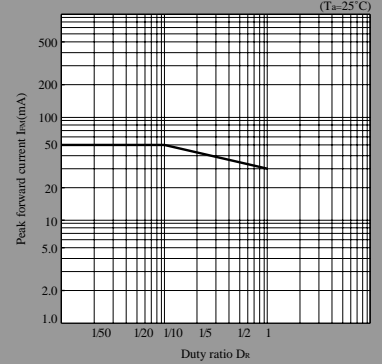

TR series

Forward Current Derating Curve

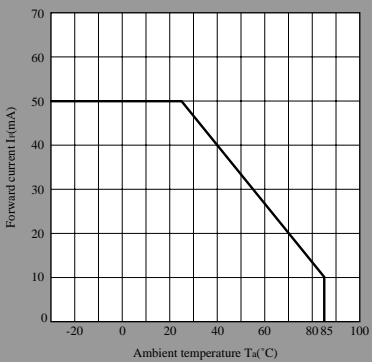

Forward Current vs. Forward Voltage(Note)

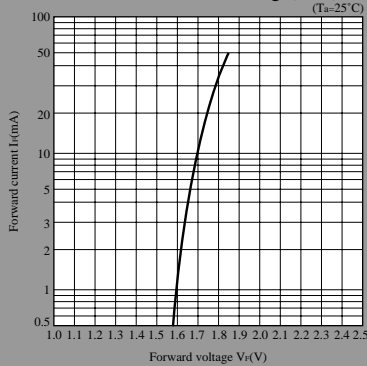

Luminous Intensity vs. Ambient Temperature(Note)

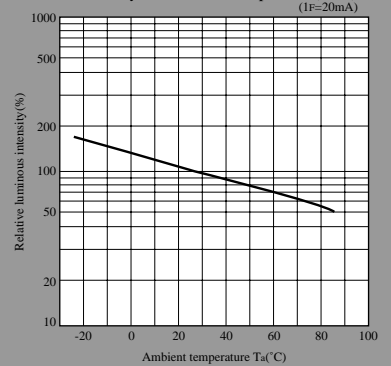

Peak Forward Current Derating Curve

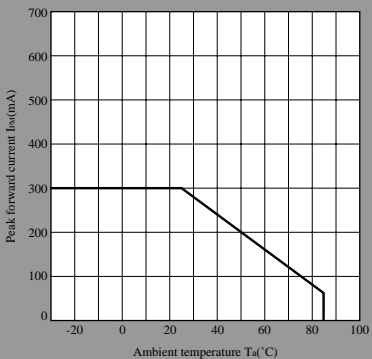

Luminous Intensity vs. Forward Current(Note)

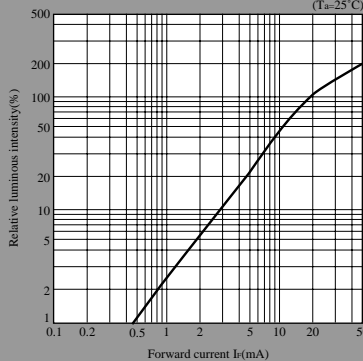

Duty Ratio vs. Peak Forward Current

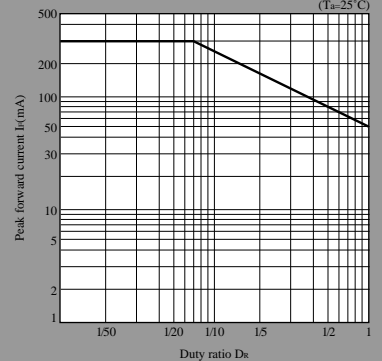

Note) Characteristics shown in diagrams are typical values. (not assurance value)

- (Notice) • In the absence of confirmation by device specification sheets, SHARP takes no responsibility for any defects that may occur in equipment using any SHARP devices shown in catalogs, data books, etc. Contact SHARP in order to obtain the latest device specification sheets before using any SHARP device.
 (Internet) • Data for sharp's optoelectronic/power device is provided for internet.(Address <http://www.sharp.co.jp/ecg/>)



LittleDiode supplies new, hard to find or obsolete electronic components and semiconductors all over the world.

With over two million different components listed you are sure to find the part you need.

Feel free to visit us today at our online store:

LittleDiode.com

Looking forward to providing you with the best possible service.