

GL380/GL381

High Output, ϕ 3mm Resin Mold Type Infrared Emitting Diode

■ Features

- High output
(I_E : MIN. 4.5mW/sr at $I_F = 50\text{mA}$, **GL380**)
(I_E : MIN. 8.5mW/sr at $I_F = 50\text{mA}$, **GL381**)
- Compact ϕ 3mm resin mold package
- Narrow beam angle($\Delta\theta$: TYP. $\pm 13^\circ$)

■ Applications

- Floppy disk drives
- Optoelectronic switches
- Infrared applied systems

■ Absolute Maximum Ratings (Ta = 25°C)

Parameter	Symbol	Rating	Unit
Forward current	I_F	60	mA
*1Peak forward current	I_{FM}	1	A
Reverse voltage	V_R	6	V
Power dissipation	P	150	mW
Operating temperature	T_{opr}	- 25 to + 85	°C
Storage temperature	T_{stg}	- 40 to + 85	°C
*2Soldering temperature	T_{sol}	260	°C

*1 Pulse width $\leq 100\mu\text{s}$, Duty ratio = 0.01

*2 For 3 seconds at the position of 2.6mm from the bottom face of resin package.

■ Electro-optical Characteristics (Ta = 25°C)

Parameter	Symbol	Conditions	MIN.	TYP.	MAX.	Unit
Forward voltage	V_F	$I_F = 50\text{mA}$	-	1.3	1.5	V
Peak forward voltage	V_{FM}	$I_{FM} = 0.5\text{A}$	-	2.2	3.5	V
Reverse current	I_R	$V_R = 3\text{V}$	-	-	10	μA
*3Radiant intensity	GL380	$I_F = 50\text{mA}$	4.5	11	-	mW/sr
	GL381		8.5	20	-	
Peak emission wavelength	λ_P	$I_F = 5\text{mA}$	-	950	-	nm
Half intensity wavelength	$\Delta\lambda$	$I_F = 5\text{mA}$	-	45	-	nm
Terminal capacitance	C_t	$V_R = 0, f = 1\text{MHz}$	-	70	-	pF
Response frequency	f_C		-	300	-	kHz
Half intensity angle	$\Delta\theta$	$I_F = 20\text{mA}$	-	± 13	-	°

*3 I_E : Value obtained by converting the value in power of radiant fluxes at the solid angle of 0.01 sr(steradian)the direction of mechanical axis of the lens portion into 1 sr of all those emitted from the light emitting diode.

■ Outline Dimensions (Unit : mm)

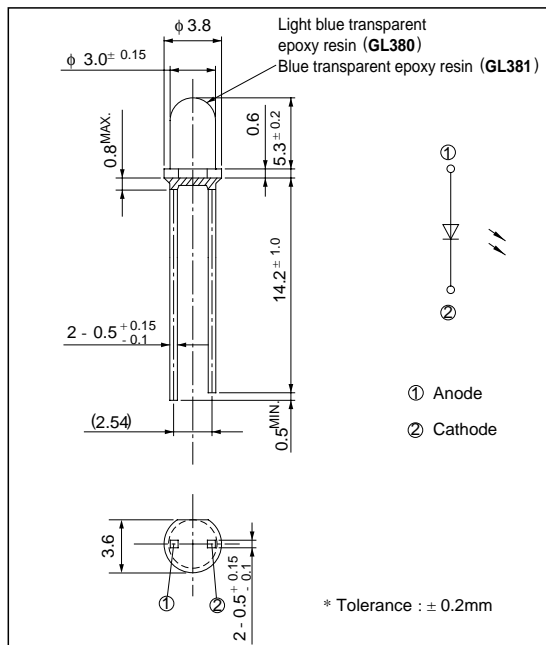

Fig. 1 Forward Current vs. Ambient Temperature

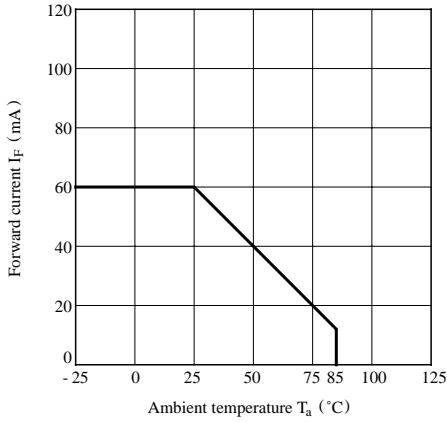

Fig. 2 Peak Forward Current vs. Duty Ratio

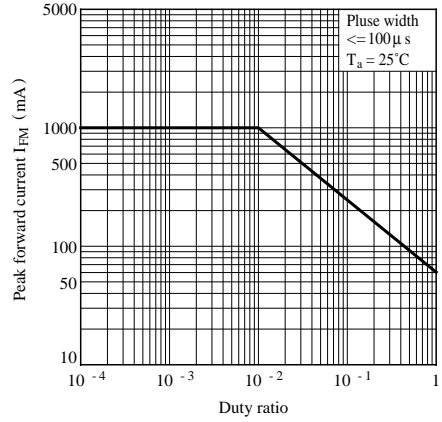

Fig. 3 Spectral Distribution

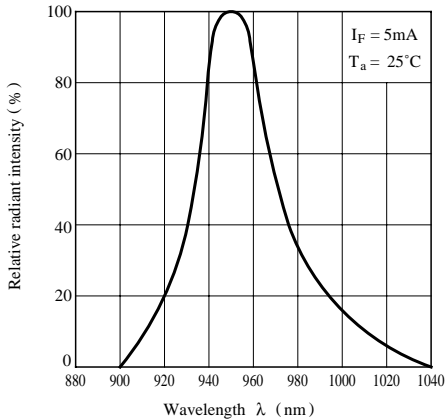

Fig. 4 Peak Emission Wavelength vs. Ambient Temperature

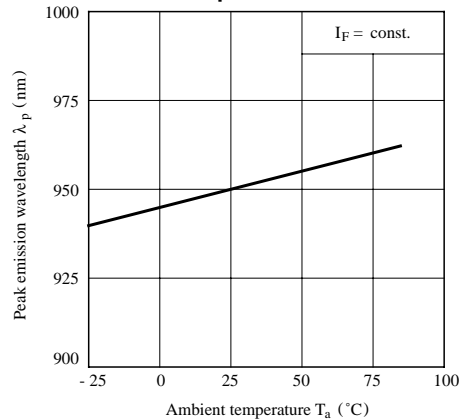

Fig. 5 Forward Current vs. Forward Voltage

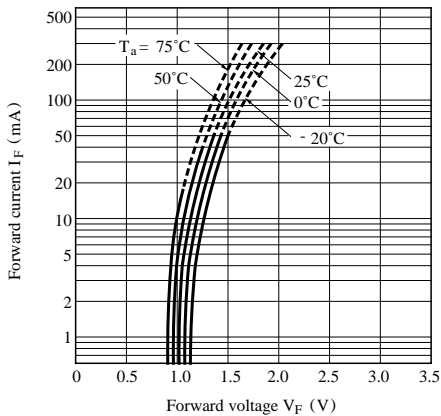

Fig. 6 Relative Radiant Flux vs. Ambient Temperature

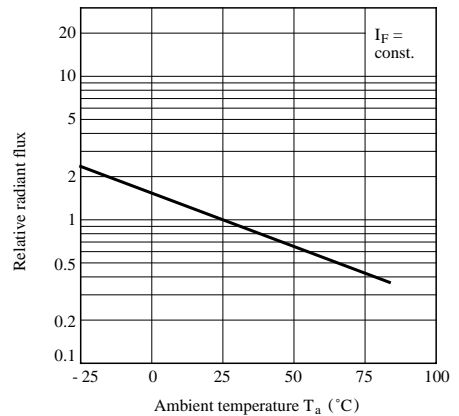

Fig. 7 Radiant Intensity vs. Forward Current

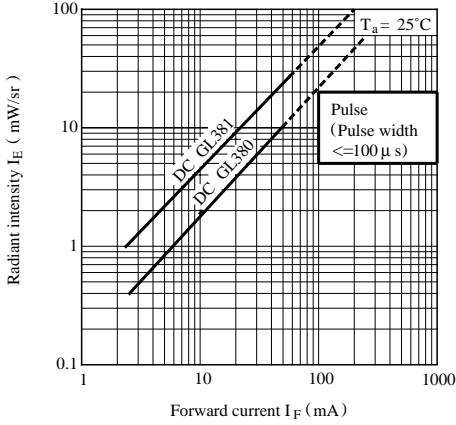

Fig. 8 Relative Collector Current vs. Distance
(Detector : PT380 / PT381)

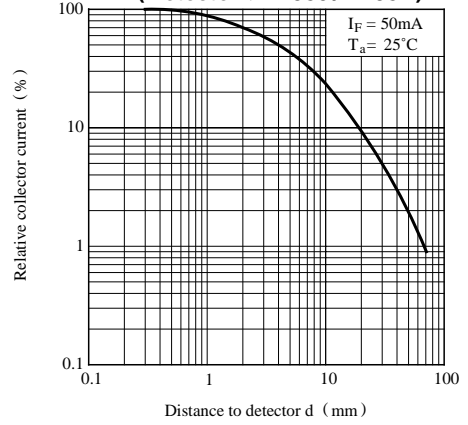
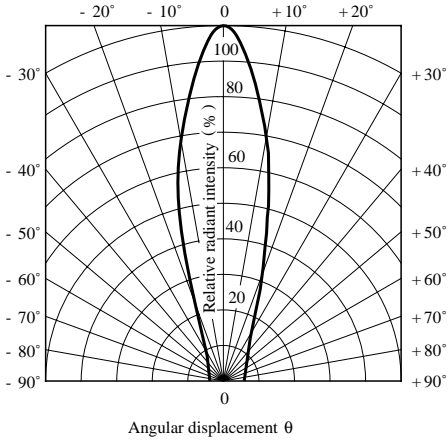

Fig. 9 Radiation Diagram



● Please refer to the chapter “Precautions for Use”



LittleDiode supplies new, hard to find or obsolete electronic components and semiconductors all over the world.

With over two million different components listed you are sure to find the part you need.

Feel free to visit us today at our online store:

LittleDiode.com

Looking forward to providing you with the best possible service.