

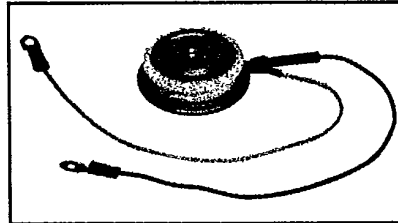

FT300DL

Powerex, Inc. Hills Street, Youngwood, Pennsylvania 15697 (412) 925-7272
 Powerex Europe, S.A., 428 Ave. G. Durand, BP107, 72003 LeMans, France (43) 72.75.15

Phase Control SCR
300 Amperes Avg
200-1200 Volts

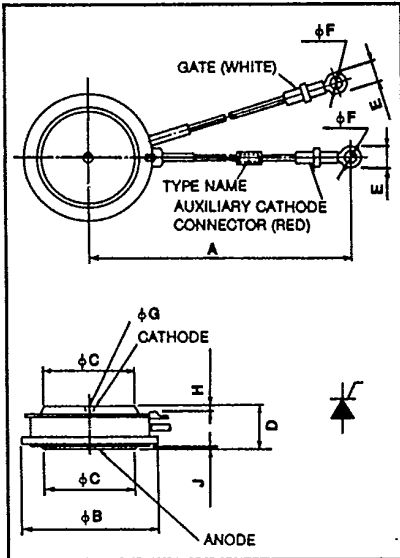

FT300DL
Phase Control SCR
 300 Amperes/200-1200 Volts

FT300DL
Outline Drawing

Dimensions	Inches	Metric
A	12.60 ± .30	320 ± 8
φB	1.968 Max	50 Max
φC	1.220	31
D	.57 ± .02	14.5 ± 0.5
E	.30	7.5
φF	.169	4.3
φG ¹	.138	3.5
H	.04 Min	1.0 Min
J	.02 Min	.04 Min

¹Depth .04 In. or 1 mm

Description

Powerex Silicon Controlled Rectifiers (SCR) are designed for phase control applications. These are all-diffused, Press-Pak (Pow-R-Disc) devices employing the field-proven amplifying (di/namic) gate.

Features:

- Low On-State Voltage
- High di/dt
- High dv/dt
- Hermetic Packaging
- Excellent Surge and I²t Ratings

Applications:

- Power Supplies
- Battery Chargers
- Motor Control
- Light Dimmers
- VAR Generators

Ordering Information

Example: Select the complete eight or nine digit part number you desire from the table - i.e. FT300DL-16 is a 800 Volt, 300 Ampere Phase Control SCR.

Type	Voltage*		Current
	V _{DRM} V _{RRM}	Code	
FT300DL	200	-4	300
	300	-6	
	400	-8	
	500	-10	
	600	-12	
	800	-16	
	1000	-20	
1200	-24		

*Voltage classes 8, 12, 16, and 24 are standard; others are special products



Powerex, Inc., Hillis Street, Youngwood, Pennsylvania 15697 (412) 925-7272

Powerex Europe, S.A., 428 Ave. G. Durand, BP107, 72003 LeMans, France (43) 72.75.15

FT300DL

Phase Control SCR

300 Amperes Avg/200-1200 Volts

Absolute Maximum Ratings

	Symbol	FT300DL	Units
RMS On-State Current	$I_{T(RMS)}$	470	Amperes
Average On-State Current	$I_{T(av)}$	300	Amperes
Peak One-Cycle Surge (Non-Repetitive) On-State Current (60Hz)	I_{TSM}	8000	Amperes
Peak One-Cycle Surge (Non-Repetitive) On-State Current (50Hz)	I_{TSM}	7300	Amperes
Critical Rate-of-Rise of On-State Current (Non-Repetitive)	di/dt	500	Amperes/ μ s
Critical Rate-of-Rise of On-State Current (Repetitive)	di/dt	200	Amperes/ μ s
I^2t (for Fusing), one cycle at 60Hz	I^2t	2.7×10^6	A^2sec
Peak Gate Power Dissipation	P_{GM}	10	Watts
Average Gate Power Dissipation	$P_{G(av)}$	5	Watts
Storage Temperature	T_{STG}	-40 to 150	$^{\circ}C$
Operating Temperature	T_J	-40 to 125	$^{\circ}C$
Mounting Force [Ⓞ]		800 to 1000	lb.
Mounting Force [Ⓞ]		360 to 450	kg

Electrical and Thermal Characteristics

Characteristics	Symbol	Test Conditions	FT300DL	Units
Voltage—Blocking State Maximums				
Forward Leakage, Peak	I_{DRM}	$T_J = 125^{\circ}C$, V_{DRM} applied	30	mA
Reverse Leakage, Peak	I_{RRM}	$T_J = 125^{\circ}C$, V_{RRM} applied	30	mA
Current—Conducting State Maximums				
Peak On-State Voltage	V_{TM}	$I_{TM} = 940A$, $T_J = 125^{\circ}C$	1.50	Volts
Switching				
Min. Critical dv/dt exponential to V_{DRM}	dv/dt	$T_J = 125^{\circ}C$, $V_D = \frac{1}{2}V_{DRM}$	200	V/μ sec
Thermal				
Maximum Thermal Resistance, [Ⓞ] double sided cooling Junction to Sink	$R_{\theta JS}$.09	$^{\circ}C/Watt$
Gate—Maximum Parameters				
Gate Current to Trigger	I_{GT}	$V_D = 6V$, $T_J = 25^{\circ}C$, $R_L = 2\Omega$	200	mA
Gate Voltage to Trigger	V_{GT}	$V_D = 6V$, $T_J = 25^{\circ}C$, $R_L = 2\Omega$	2.5	Volts
Non-Triggering Gate Voltage	V_{GDM}	$T_J = 125^{\circ}C$, $V_D = \frac{1}{2}V_{DRM}$.20	Volts
Peak Forward Gate Current	I_{GTM}		4	Amperes
Peak Reverse Gate Voltage	V_{GRM}		5	Volts

[Ⓞ] Consult recommended mounting procedures.



Powerex, Inc., Hillis Street, Youngwood, Pennsylvania 15697 (412) 925-7272
 Powerex Europe, S.A., 428 Ave. G. Durand, BP107, 72003 LeMans, France (43) 72.75.15

FT300DL
 Phase Control SCR
 300 Amperes Avg/200-1200 Volts

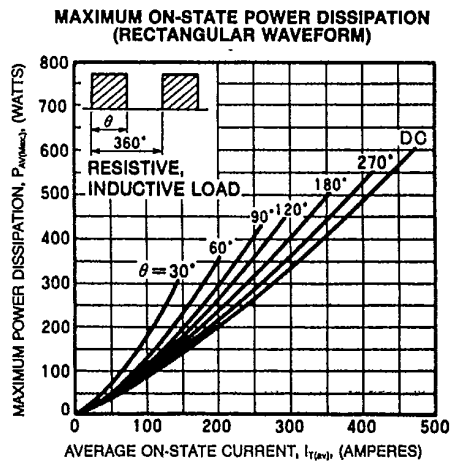
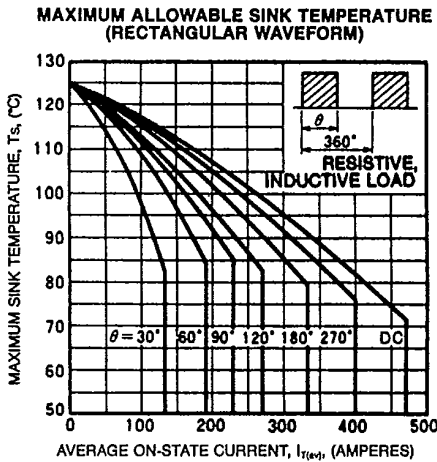
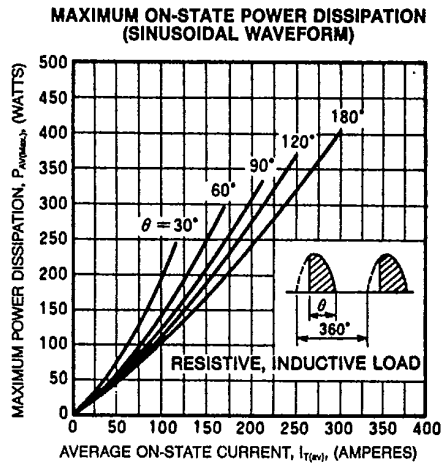
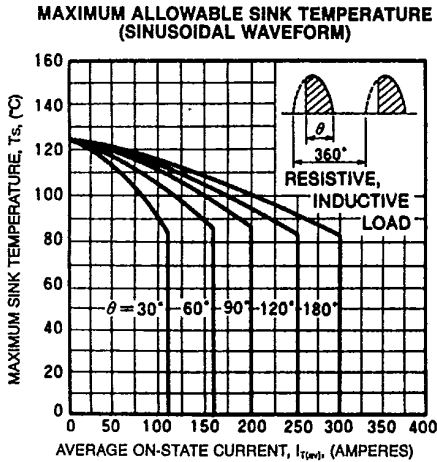
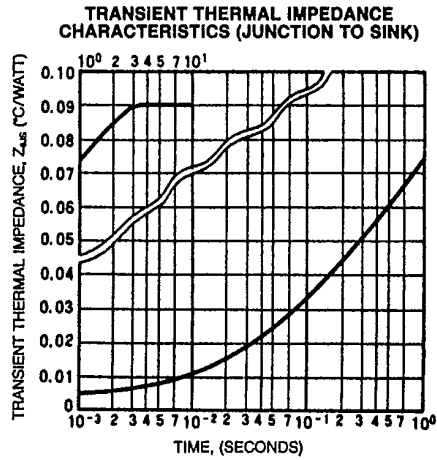
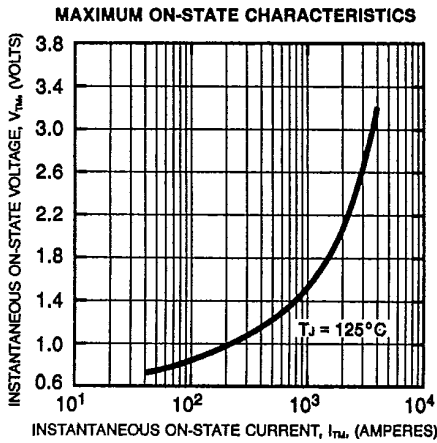



Powerex, Inc., Hills Street, Youngwood, Pennsylvania 15697 (412) 925-7272
 Powerex Europe, S.A., 428 Ave. G. Durand, BP107, 72003 LeMans, France (43) 72.75.15

FT300DL
 Phase Control SCR
 300 Amperes Avg/200-1200 Volts

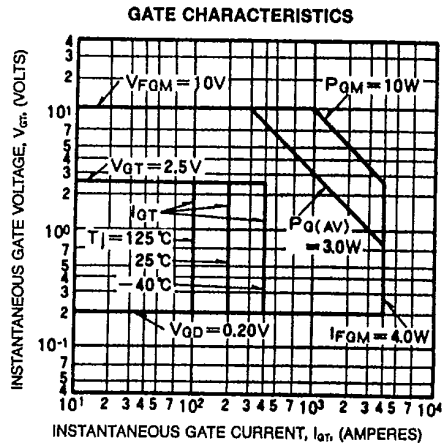
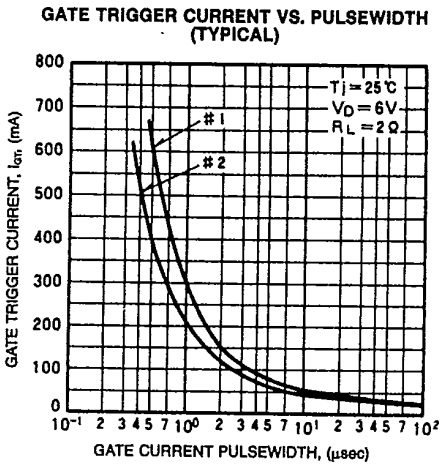
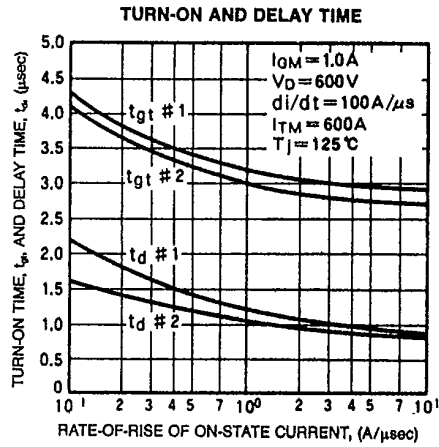
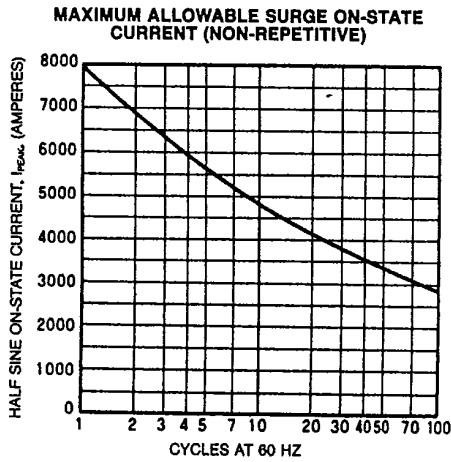



LittleDiode supplies new, hard to find or obsolete electronic components and semiconductors all over the world.

With over two million different components listed you are sure to find the part you need.

Feel free to visit us today at our online store:

LittleDiode.com

Looking forward to providing you with the best possible service.