

FM Pager/FM Multiplex Tuner

Description

The CXA1991N is a tuner IC designed for use in FM pagers and FM multiplex broadcasting. A receiver system can be configured by using the digital data output, in combination with a decoder. It has a battery save function and ultra-low power consumption.

Features

- Ultra-low power consumption  
( $I_b = 1.2 \text{ mA}$  for FM;  $I_b = 0.8 \text{ mA}$  for AM;  $V_{cc} = 3 \text{ V}$ )
- LED drive circuit for tuning
- Battery save function
- Few external parts

Applications

- Tuners for FM multiplex broadcasting
- FM pagers

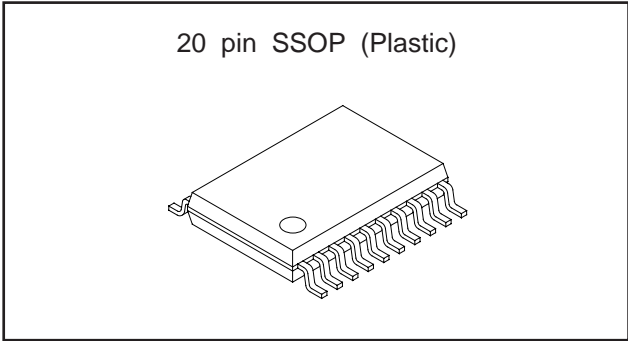

Absolute Maximum Ratings ( $T_a = 25^\circ\text{C}$ )

• Supply voltage	$V_{cc}$	14	V
• Operating temperature	$T_{opr}$	-20 to +75	$^\circ\text{C}$
• Storage temperature	$T_{stg}$	-65 to +150	$^\circ\text{C}$
• Allowable power dissipation	$P_D$	400	mW

Operating Conditions

Supply voltage	$V_{cc}$	1.8 to 4.5	V
----------------	----------	------------	---

Block Diagram

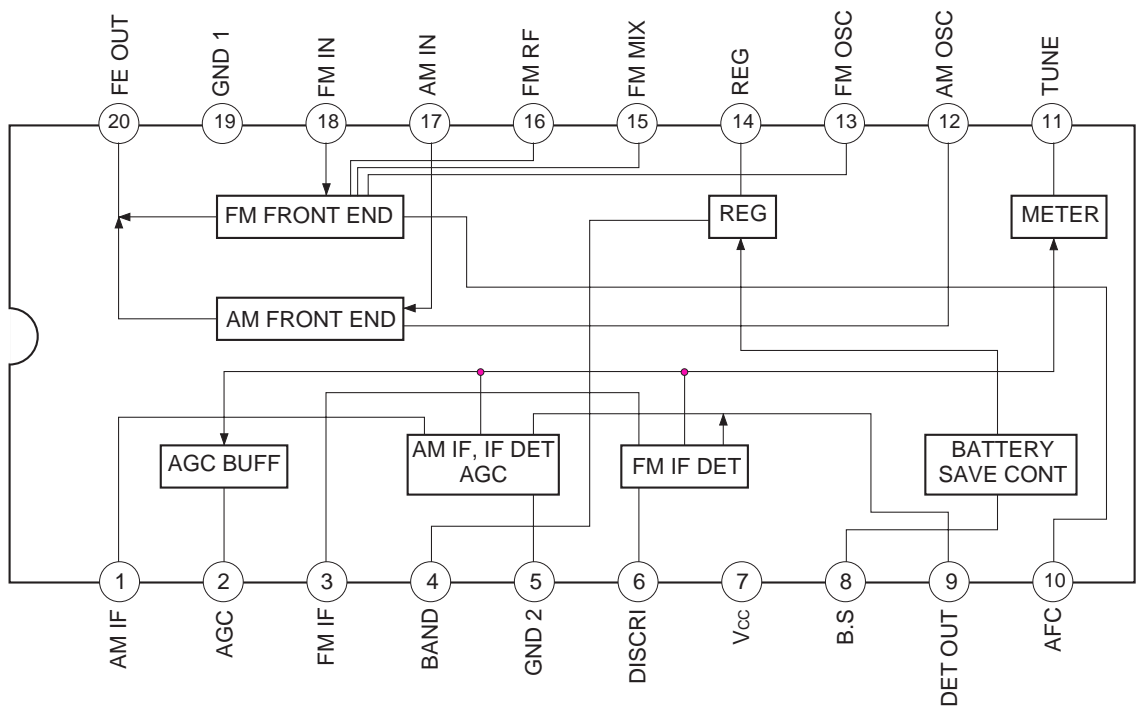

Sony reserves the right to change products and specifications without prior notice. This information does not convey any license by any implication or otherwise under any patents or other right. Application circuits shown, if any, are typical examples illustrating the operation of the devices. Sony cannot assume responsibility for any problems arising out of the use of these circuits.

Pin Description

(Vcc=3 V, Ta=25 °C)

Pin No.	Symbol	Pin voltage (V)		Equivalent circuit	Description
		FM	AM		
1	AM IF IN	1.1	1.1		AM IF input pin.
2	AGC	0.3	0.4		Connected to a capacitor.
9	DET OUT	0.9	0.7		Detection output pin.
3	FM IF IN	1.1	0		FM IF input pin.
4	BAND	1.1	0		AM/FM band switching pin. AM when grounded, FM when open.
5	GND2	0	0		IF system ground.
6	DISCRI	2.0	2.4		Connected to phase shift circuit and ceramic discriminator.
7	Vcc	3.0	3.0		

Pin No.	Symbol	Pin voltage (V)		Equivalent circuit	Description
		FM	AM		
8	BS				Controls battery save via microcomputer. High = Active, Low = Save
10	AFC	1.0	0.7		AFC varicap pin.
13	FM OSC	1.1	1.1		FM local oscillation circuit.
11	TUNE	1.1	1.1		AM/FM tuning indicator drive circuit.
12	AM OSC	1.1	1.1		AM local oscillation circuit.
14	REG	1.1	1.1		Regulator output pin.

Pin No.	Symbol	Pin voltage (V)		Equivalent circuit	Description
		FM	AM		
15	FM MIX	1.1	1.1		Load for mixer which resonates at 10.7 MHz from internal capacitance and external coil.
16	FM RF	1.1	1.1		FM RF amplifier circuit which is connected to RF tank circuit
18	FM RF IN	2.2	2.4		FM RF amplifier circuit which is FM RF input.
17	AM RF IN	1.1	1.1		AM RF input which is connected to bar antenna.
19	GND1	0	0		Front-end ground.
20	FE OUT	0.6	1.5		AM/FM IF output pin which is connected to IF filter.

V<sub>CC</sub>=3 V, T<sub>a</sub>=25 °C

Electrical Characteristics

Functional block	Measurement No.	Measurement item	Bias and SW conditions							Input point	Input waveform and bias description	Measurement point	Output waveform and measurement method description	MIN Limit			
			S1	S2	S3	S4	S5	S6	S7					Min.	Typ.	Max.	Unit
Standard Bias Conditions																	
1		Current consumption for FM no signal	OFF	OFF	OFF	OFF	OFF	FEUT		—	A1			0.60	1.25	1.90	mA
2		Current consumption for AM no signal		ON						—				0.30	0.75	1.20	mA
3		Current consumption for battery save		OFF	ON					—				—	—	1.00	μA
4		FM front-end gain	ON	OFF	OFF					V2	VA	10.7 MHz		10	20	30	dB
5		FM detection output level								V3	VD	Vin=90 dBμV, 10.7 MHz 22.5 kHz DIV		39.0	73.5	123.5	mVrms
6		FM IF knee level									VB	V3 level when VB level for input of V3 = 90 dBμV drops by -3 dB.		22.5	33.0	43.5	dBμV
7		FM detection output distortion												—	0.3	1.0	%
8		IF center frequency offset									9 pin-14 pin	Frequency offset from 10.7 MHz when Pin 9-Pin 14 DC potential difference is 0 mV.		-50	0	50	kHz
9		FM meter current		ON		ON					A2			1.25	2.90	4.45	mA
10		AM front-end gain		ON		OFF	ON			V1	VA	455 kHz		25	28	31	dB
11		AM IF gain								V4	VD	VIN level for -40 dBm output.		25.0	29.0	33.0	dBμV
12		AM detection output level									VD			43.5	65.5	98.0	mVrms
13		AM meter current				ON					A2			1.50	2.9	4.30	mA
14		AM detection output distortion	OFF			OFF				V1	VB	Vin=100 dBμV, 1660 kHz, 30 %		—	0.60	3.00	%



Application Circuit

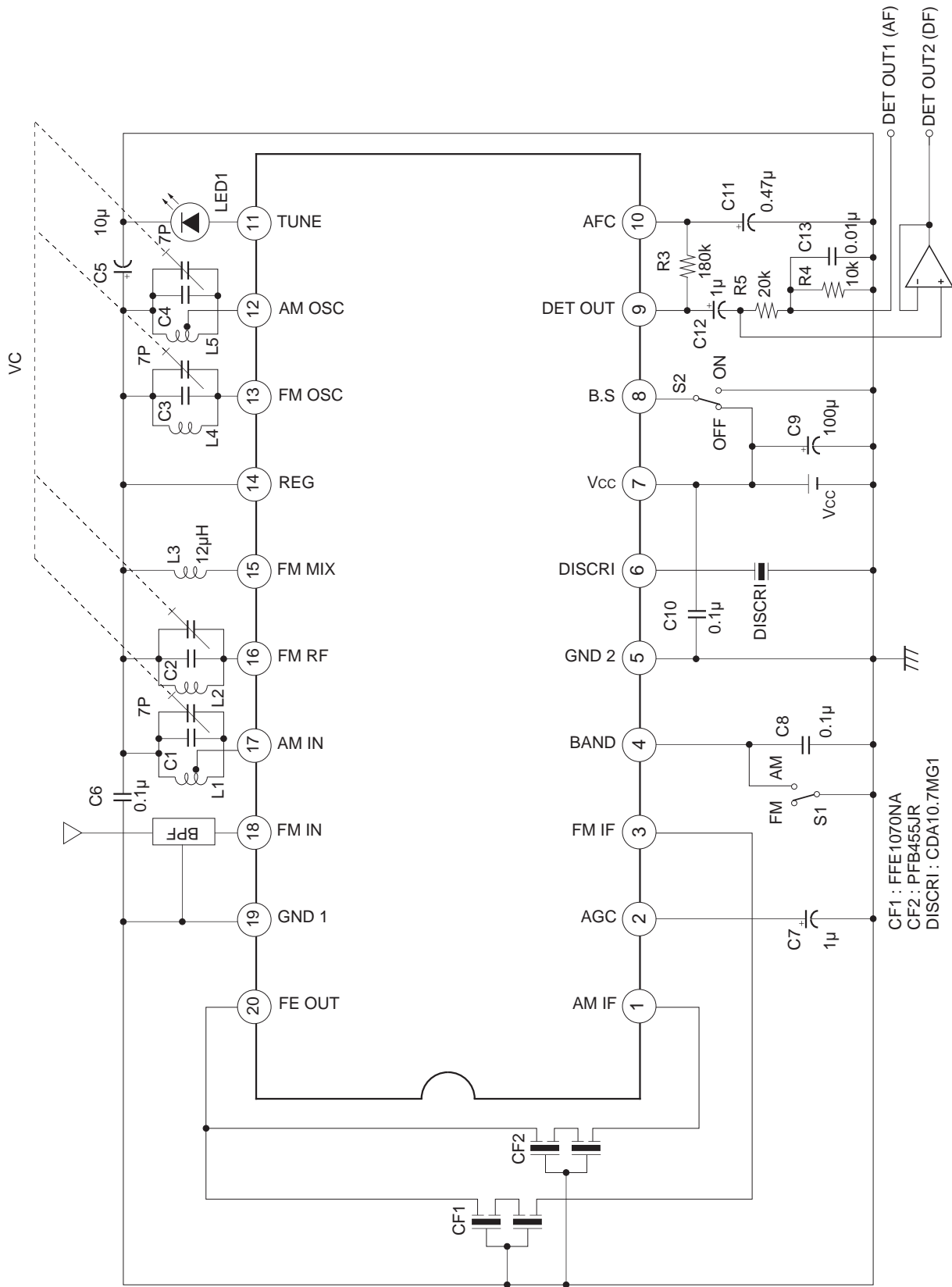

Application circuits shown are typical examples illustrating the operation of the devices. Sony cannot assume responsibility for any problems arising out of the use of these circuits or for any infringement of third party patent and other right due to same.

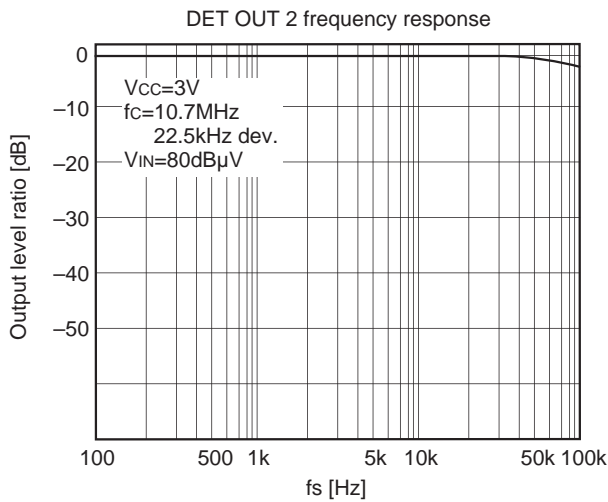
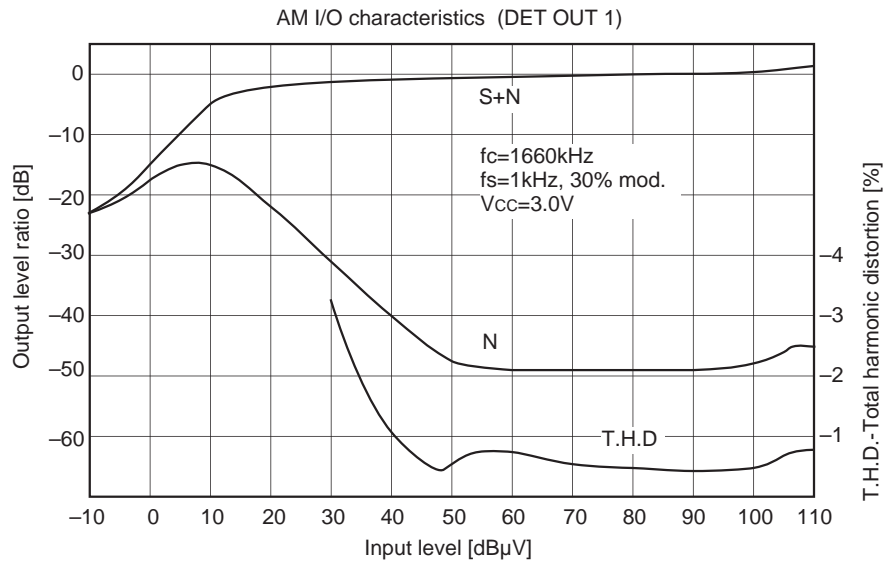
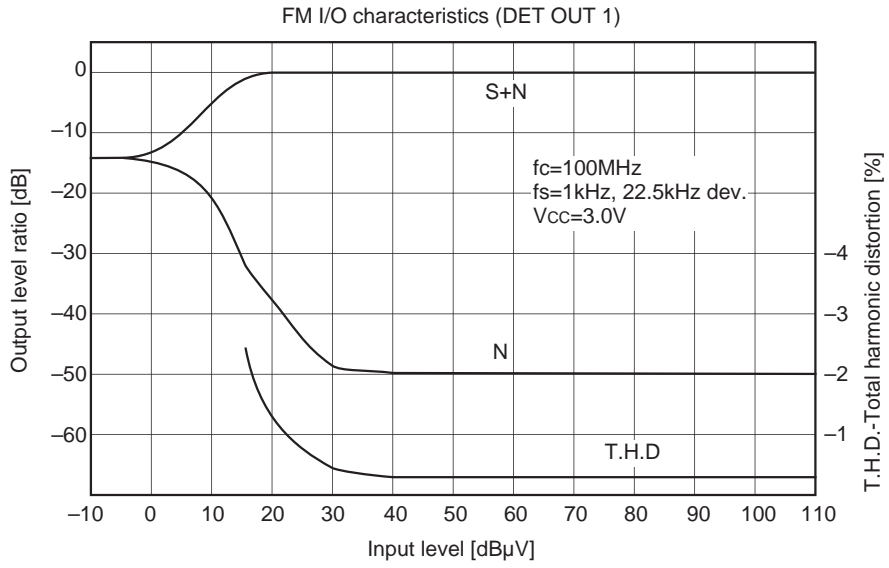

Coil Data

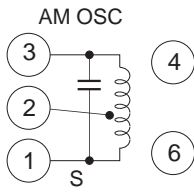

Core diameter  $\phi$  0.06 2UEW

f [MHz]	C [pF]	Q	Number of windings [t]		
			1 to 3	1 to 2	2 to 3
2.11	33	40	56	14	42

Equivalent to L7BRCS-1726Y TOKO Co., Ltd.

FM OSC

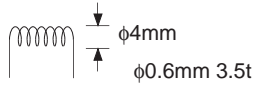

FM RF

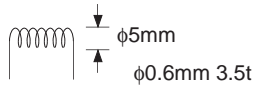

AM bar antenna

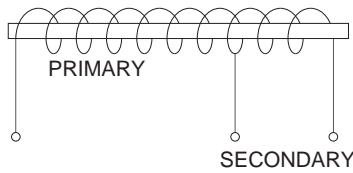

Core diameter  $\phi$  0.09 USTC

f [kHz]	L [ $\mu$ H]	Primary	Secondary	Q
796	650	121t	22t	120

CF1	FFE1070NA	TDK Co., Ltd.
CF2	PFB455JR	Murata Mfg. Co., Ltd.
DISCRI	CDA10.7MG1	Murata Mfg. Co., Ltd.
VC	PVC2LXT16L	Mitsumi Electric Co., Ltd.
VC (Rear Mount)	HU22124N700	TOKO Co., Ltd.
	PVC2LXT16B	Mitsumi Electric Co., Ltd.

## Notes on Operation

## 1. De-emphasis time constant

Time constants are determined by R4, R5 and C13. The calculation formula is as follows.

$$\{R4 \cdot R5 / (R4 + R5)\} \cdot C13$$

## 2. FM discriminator

Quadrature detection is used for FM detection. A ceramic resonator is used in the phase shifter so that no adjustment is required. In order to eliminate problems of distortion and offset with IF band center frequency, the CF1 (FM • IF) and FM discrete pair combination should be of the same level.

	CF1 and Discrete fo
A red	10.70 MHz
B blue	10.67 MHz
C orange	10.73 MHz
D black	10.64 MHz
E white	10.76 MHz

## 3. Battery save function

The battery save function operates when Pin 8 is grounded. Current consumption is 1  $\mu$ A or less during battery save. To switch from battery save mode to normal mode, Pin 8 is connected to Vcc. At this time the DET OUT (Pin 9) rise time is affected by the rise time of Pins 4, 10 and 14. For faster rise time, lower the capacitance values of bias capacitors C5, C6 and C8, taking care that characteristics do not deteriorate. Also, decrease or eliminate R3 and C11 time constants and control Pin 10 directly with DC voltage of approximately 1.1 V to improve rise time.

## 4. Notes on pattern preparation

## i) FM antenna, OSC coil configuration

Change the direction 90 degrees in order to avoid M coupling. Also, insert Pin 14 pattern between Pins 13 and 16 and the pattern between the coils. (See "Standard Board Diagram".)

## ii) Tuning circuit

The capacitance value of the tuning circuit varies according to the board; investigate the time constants for new boards.

## iii) GND pins

Pin 5 is the ground pin for IF and Pin 19 is the ground pin for FE. Use as thick a pattern as possible for the antenna input, BPF and Pin 19 grounds, as they have a significant effect on stability and NF characteristics.

iv) The ground point for by-pass capacitors C5 and C6 connected to Pin 14 should be as close to Pin 14 as possible.

v) When the tuning indicator is not used, connect Pin 11 to ground. This will put the tuning indicator drive circuit into low power consumption mode and current ceases to flow to the indicator. Also, the current consumption Icc is eliminated.

vi) Use the BPF for FM.

Standard Board Diagram

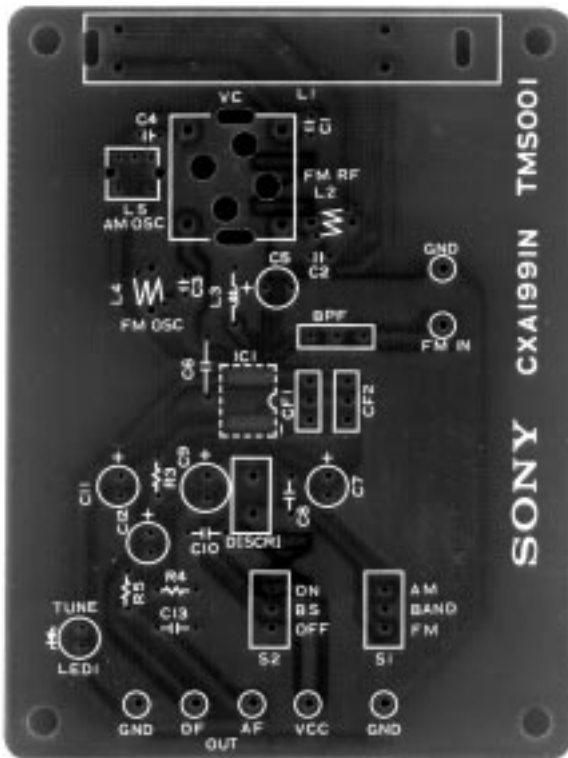

Component side symbols

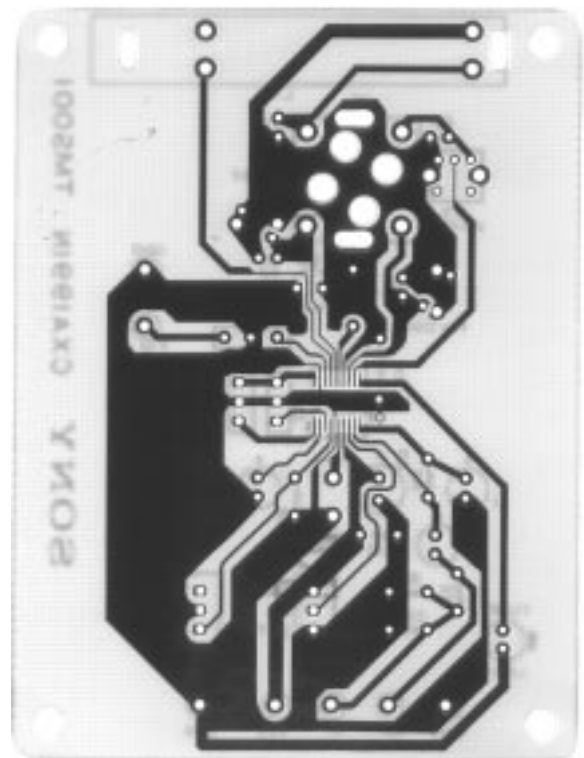

Solder pattern side

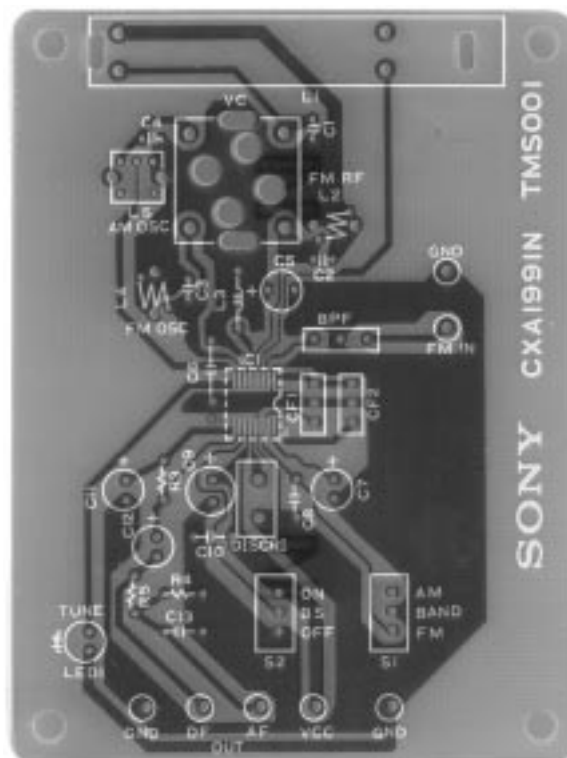

Component pattern side

Package Outline Unit : mm

20PIN SSOP (PLASTIC)

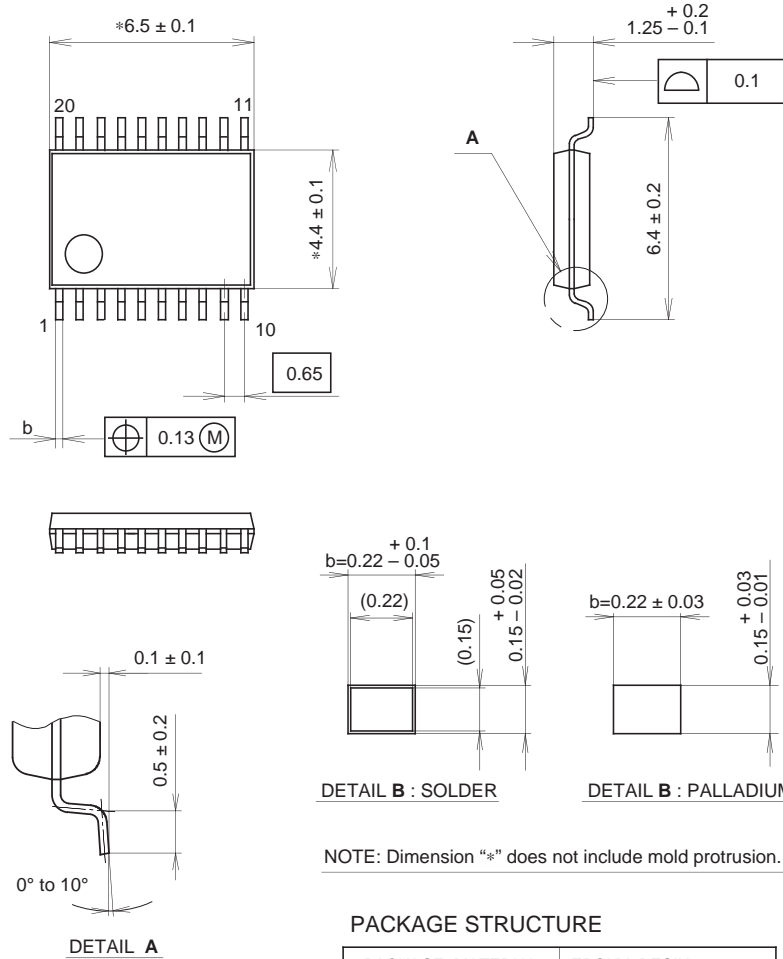

NOTE: Dimension "\*" does not include mold protrusion.

PACKAGE STRUCTURE

PACKAGE MATERIAL	EPOXY RESIN
LEAD TREATMENT	SOLDER / PALLADIUM PLATING
LEAD MATERIAL	42/COPPER ALLOY
PACKAGE MASS	0.1g

SONY CODE	SSOP-20P-L01
EIAJ CODE	SSOP020-P-0044
JEDEC CODE	_____

NOTE : PALLADIUM PLATING  
 This product uses S-PdPPF (Sony Spec.-Palladium Pre-Plated Lead Frame).



LittleDiode supplies new, hard to find or obsolete electronic components and semiconductors all over the world.

With over two million different components listed you are sure to find the part you need.

Feel free to visit us today at our online store:

[LittleDiode.com](http://LittleDiode.com)

Looking forward to providing you with the best possible service.