

Up/Down Converter for 900 MHz-Band Mobile Communications

Description

The CXA1851N is an up/down converter IC for 900 MHz-band mobile communications.

This is suitable for 900 MHz-band digital cordless telephone (CT2) and digital cellular.

Features

- Transmission/reception converter on a single chip
- Operating frequency: 800 to 900 MHz
- Supply voltage: 2.7 to 4.5 V
- Power saving function
- 20-pin SSOP package used for set size reduction

Applications

- CT2 digital cordless telephone
- Digital cellular

Structure

Bipolar silicon monolithic IC

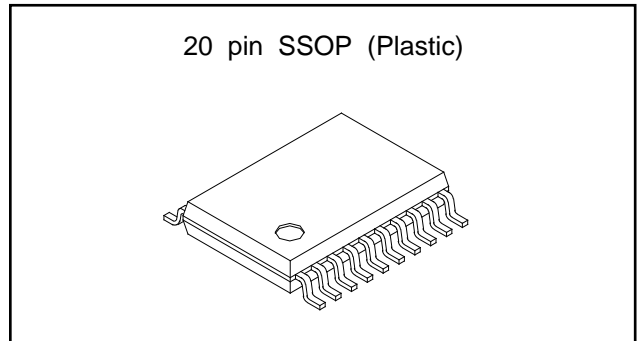

Absolute Maximum Ratings (Ta=25°C)

• Supply voltage	Vcc	5	V
• Operating temperature	Topr	-20 to +75	°C
• Storage temperature	Tstg	-65 to +150	°C
• Allowable power dissipation	Pd	530*	mW

* When mounted on a 505x0x1.6 mm copper-foiled glass epoxy board

Recommended Operating Conditions

Supply voltage	Vcc	2.7 to 4.5	V
----------------	-----	------------	---

Block Diagram and Pin Configuration

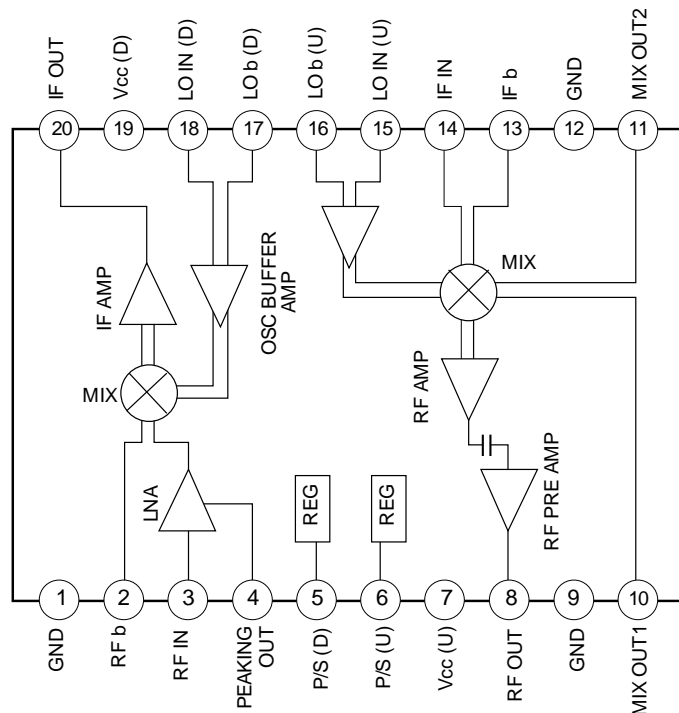

Sony reserves the right to change products and specifications without prior notice. This information does not convey any license by any implication or otherwise under any patents or other right. Application circuits shown, if any, are typical examples illustrating the operation of the devices. Sony cannot assume responsibility for any problems arising out of the use of these circuits.

Pin Description

Pin No.	Symbol	Typical pin voltage (V)	Equivalent circuit	Description
1	GND	0.0	—————	GND pin for the down converter.
2	RF BYPASS	1.1		MIX input by-pass pin for the down converter.
3	RF INPUT	0.9		RF input pin for the down converter. Because of high impedance, a 4.7 nH external chip inductor should be used for impedance matching.
4	PEAKING OUT	0.12		Emitter pin for the low-noise amplifier. Connect an approximately 3 pF chip capacitor and an approximately 22Ω chip resistor in series to the GND.
5	P/S (for DOWN CONV.)	0 to 4.5		Power saving control pin for the down converter. OFF when $V_{p/s} \leq 1.0$ V; ON when $V_{p/s} \geq 1.8$ V
6	P/S (for UP CONV.)	0 to 4.5		Power saving control pin for the up converter. OFF when $V_{p/s} \leq 1.0$ V; ON when $V_{p/s} \geq 1.8$ V
7	Vcc (for Up CONV.)	2.7 to 4.5		Power supply for the up converter.
8	RF OUTPUT	2.7 ($V_{cc}=2.7V$)		RF output pin for the up converter. Connect this pin to the Pin 7 power supply via the 15 nH chip inductor.
9	GND	0.0		GND pin for the up converter RF amplifier.

Pin No.	Symbol	Typical pin voltage (V)	Equivalent circuit	Description
10	MIX OUT1	2.3		MIX output pin for the up converter.
11	MIX OUT2	2.3		MIX output pin for the up converter. Connect an approximately 4.7 nH chip inductor and an approximately 3.5 pF chip capacitor between this pin and Pin 10 to form a tank circuit.
12	GND	0.0		GND pin for the oscillator buffer amplifier and mixer blocks of the up converter.
13	IF BYPASS	1.03		IF input by-pass pin for the up converter.
14	IF INPUT	1.03		IF input pin for the up converter. Because of high impedance, an external matching circuit is necessary which consists of a 220 nH chip inductor and an approximately 1.5 pF chip capacitor.
15	OSC INPUT (for UP CONV.)	1.8		Oscillator input pin for the up converter. A matching circuit consisting of a 51Ω resistor is necessary.
16	OSC BYPASS (for UP CONV.)	1.8		Oscillator input by-pass pin for the up converter.
17	OSC BYPASS (for DOWN CONV.)	1.85		Oscillator input by-pass pin for the down converter.
18	OSC BYPASS (for DOWN CONV.)	1.85		Oscillator input pin for the down converter. A matching circuit consisting of a 51Ω resistor is necessary.
19	Vcc (for DOWN CONV.)	2.7 to 4.5		Power supply for the down converter.
20	IF OUTPUT	1.45		IF output pin for the down converter.

Electrical Characteristics

(Ta=25°C, Vcc=2.7V, ZL=Zs=50Ω)

Item	Symbol	Conditions	Min.	Typ.	Max.	Unit
Up Converter Block *1						
Current consumption	Icc	For no signal input	18.0	25.0	35.0	mA
Conversion gain	CG	Pin= - 40dBm	17.5	20.5	25.5	dB
RF output power	Pout	Pin= -10dBm, 50Ω load	0	3		dBm
Noise figure	NF	DSB mode		13	18	dB
Lo leak	ISO (Lo)	Pin= - 10dBm		- 25.0	- 10	dBm
IF leak	ISO (IF)	Pin= - 10dBm		- 12.0	- 5	dBm
Standby current consumption	Icc (PD)	6pin (P/S)<1.0V		220 *2	350 *2	μA
Power saving control voltage	Vp/s (ON)		1.8		4.5	V
	Vp/s (OFF)				1.0	V
Rise time	Tup			2.5	5.0	μs
Down Converter Block *3						
Current consumption	Icc	For no signal input	8.0	15.0	22.0	mA
Conversion gain	CG	Pin= - 40dBm, 50Ω load	15.0	18.0	23.0	dB
IF output power	Pout (IF)	Pin= - 10dBm, 50Ω load	- 4.5	- 2.0		dBm
Third-order intermodulation distortion	IM3	fRF1=866.4MHz, Pin1= - 40dBm	45	49.0		dBc
		fRF2=866.8MHz, Pin2= - 40dBm				
Noise figure	NF	DSB mode		7.5	10	dB
Standby current consumption	Icc (PD)	5pin (P/S)≤1.0V		220 *2	350 *2	μA
Power saving control voltage	Vp/s (ON)		1.8		4.5	V
	Vp/s (OFF)				1.0	V
Rise time	Tup			2.5	5.0	μs

*1: fIFin=150.05MHz, fRFout=864.05 to 868.05MHz

fLoIn=1014.10 to 1018.1MHz (- 9dBm)

*2: These are the total values for the up and down converters.

*3: fRFIn=864.05 to 868.05MHz

fLoIn=1014.10 to 1018.1MHz (- 9dBm)

Typical Reference characteristics

(Ta=25°C, Vcc=2.7V, ZL=Zs=50Ω)

Item	Symbol	Conditions	Typ.	Unit
Up Converter Block				
Third-order intermodulation distortion	IM3	fIF1=150.4MHz, PIF1= - 30dBm	39.0	dBc
		fIF2=150.8MHz, PIF2= - 30dBm		
Down Converter Block				
1 dB compression	P- 1dB	Output conversion, 50Ω load	- 7.0	dBm
Lo leak	ISO (Lo)	Pin= - 40dBm	- 29.0	dB
RF leak	ISO (RF)	Pin= - 40dBm	- 44.0	dB

Electrical Characteristics Test Circuit 1

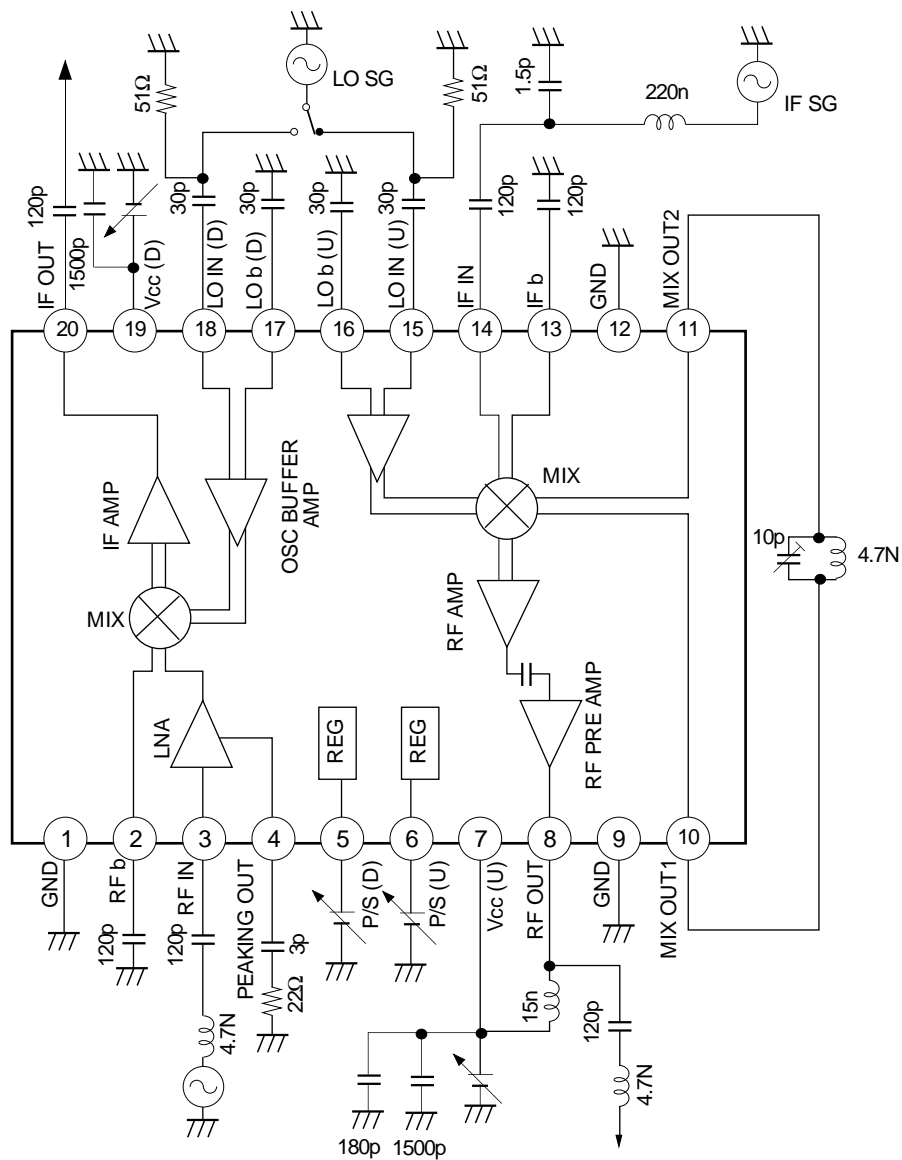

Electrical Characteristics Test Circuit 2

Items: NF (D), NF (U)

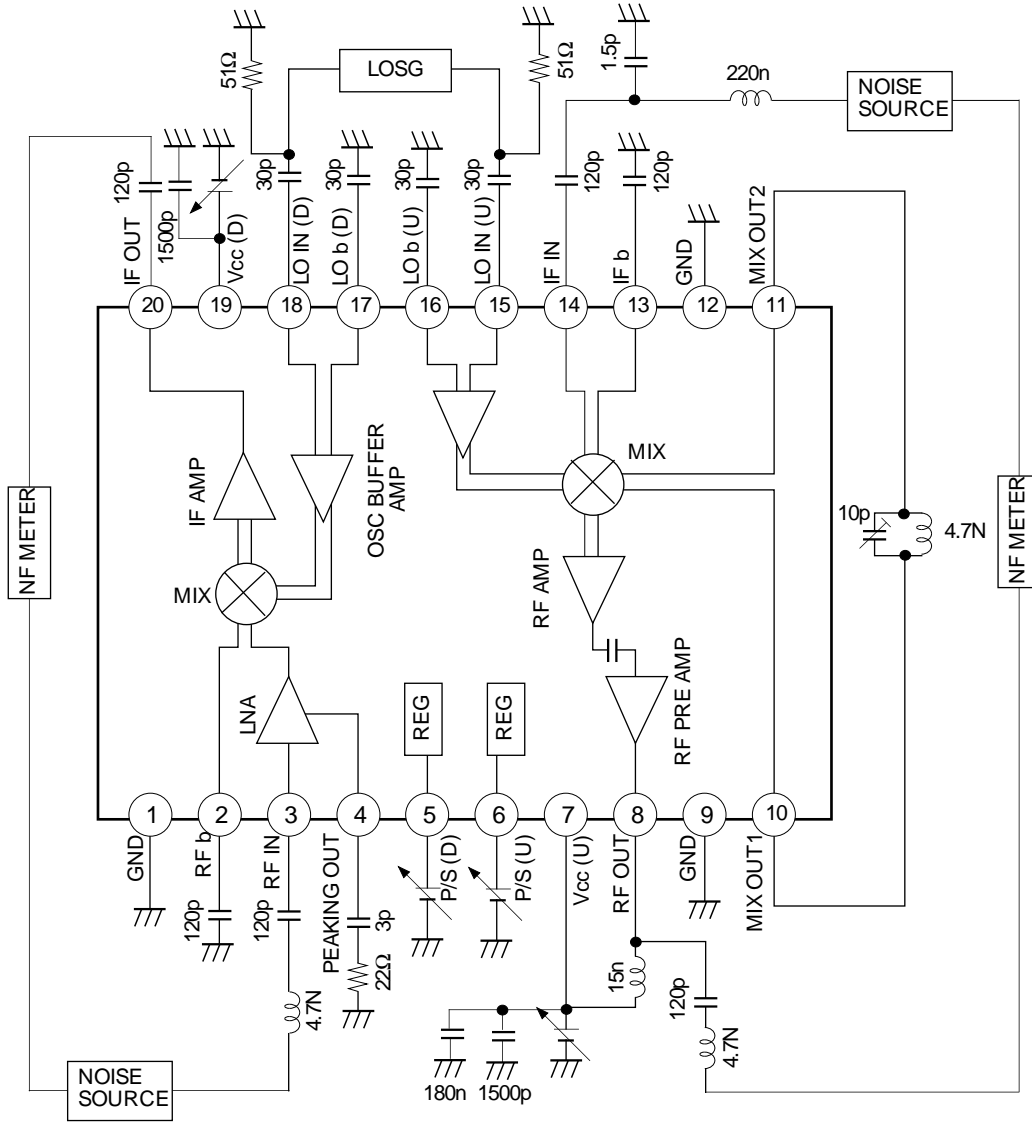

Block diagram

Digital cordless telephone chip set (CXA1744R/CXA1851N/CXA1852N)

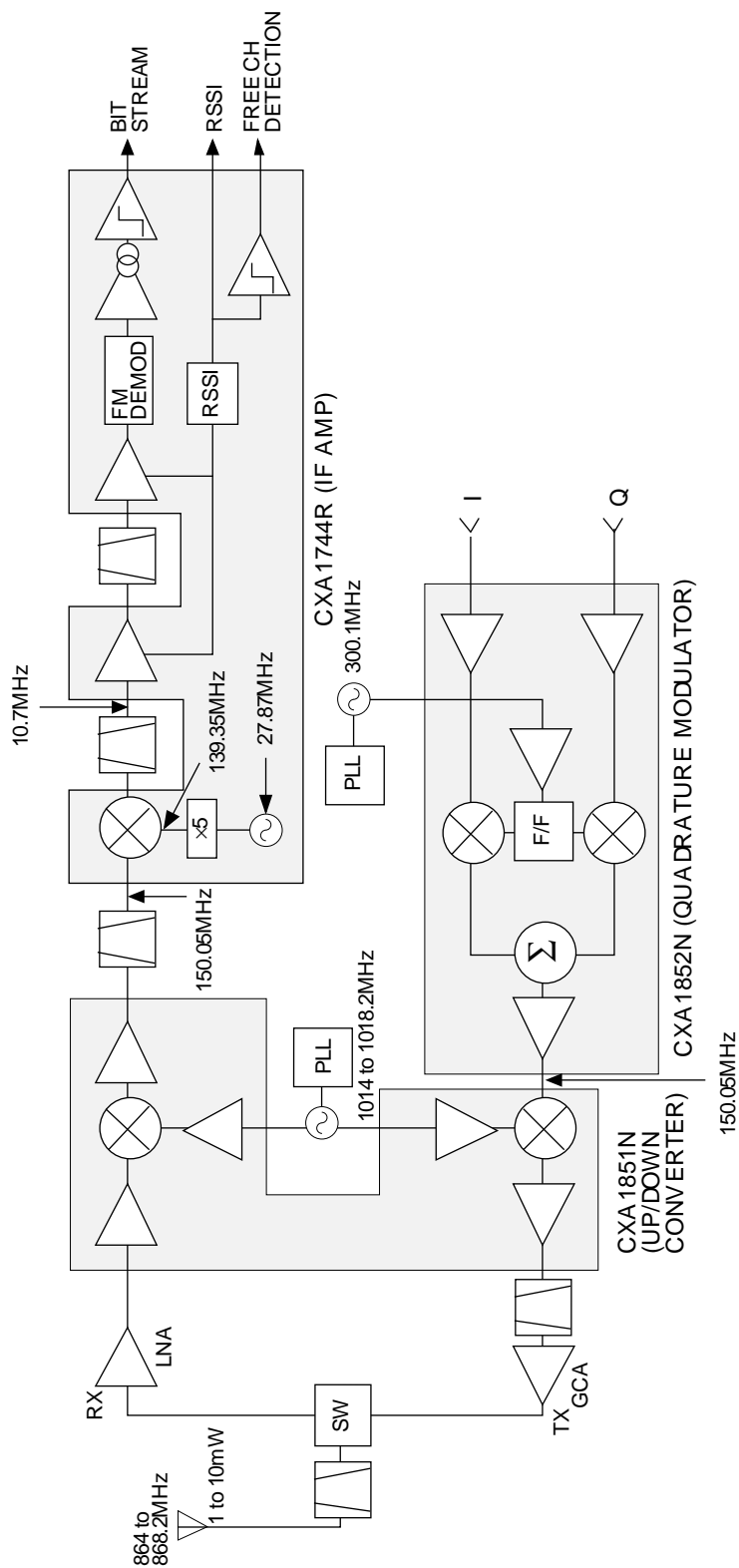

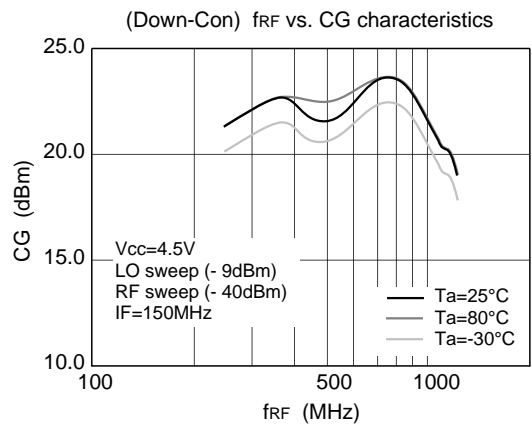
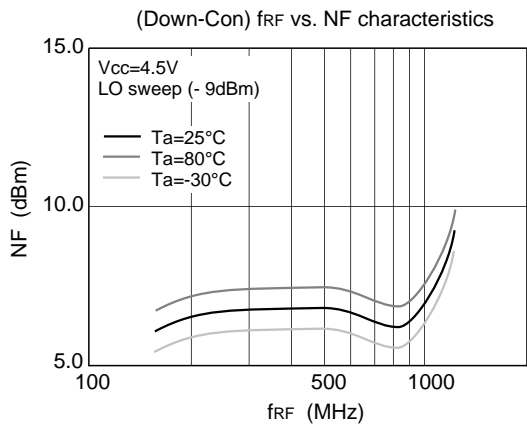
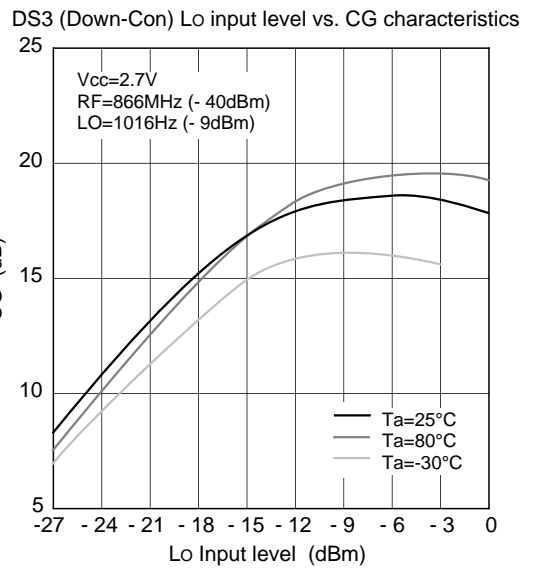
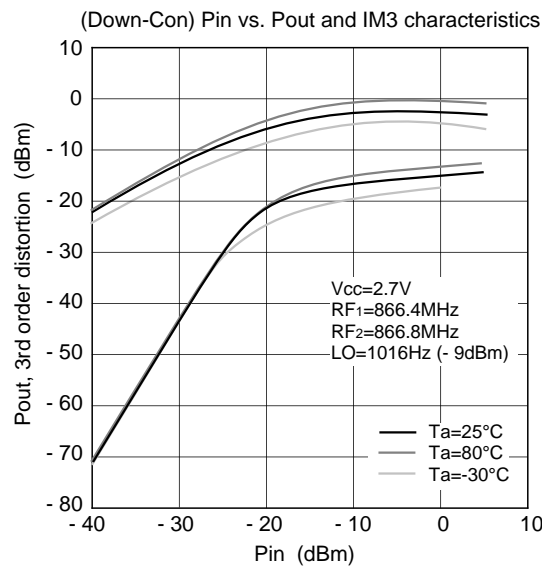
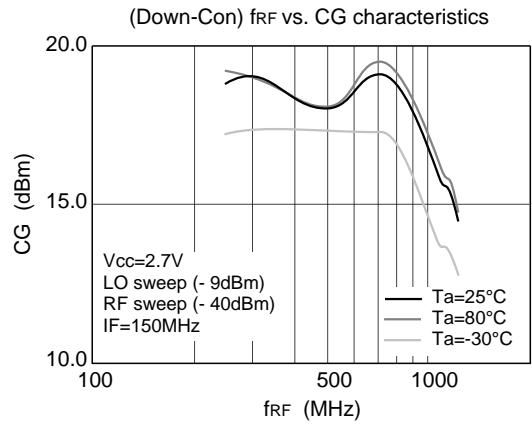
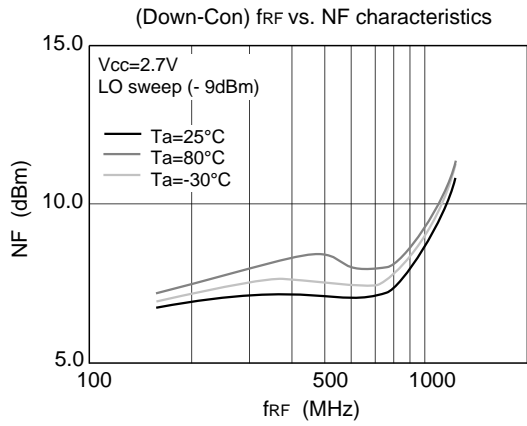

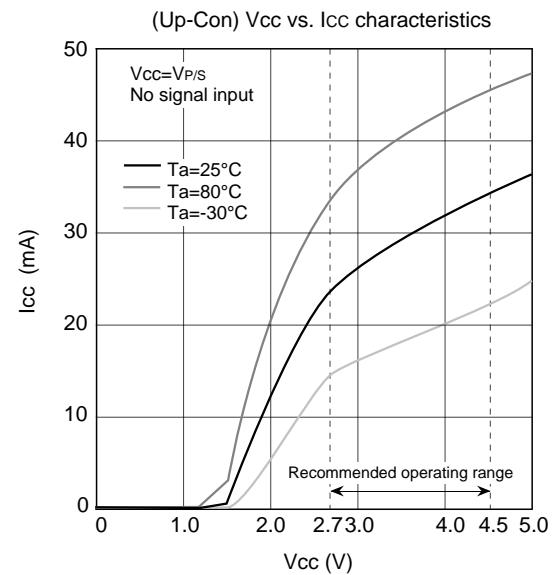
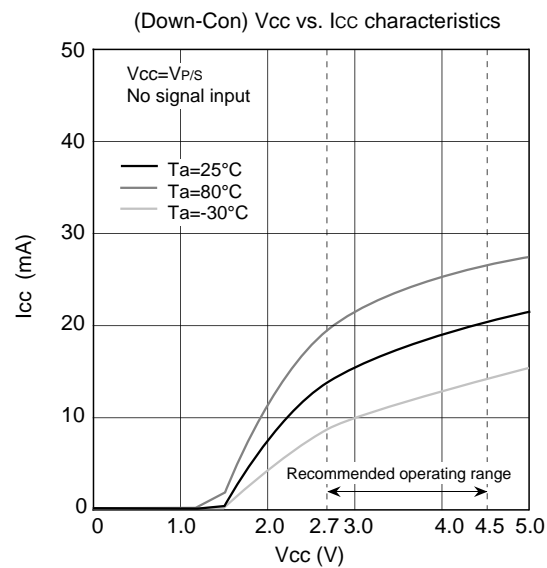
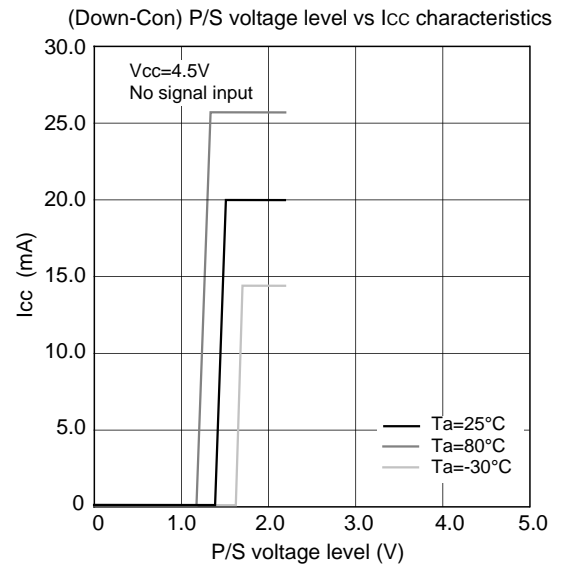
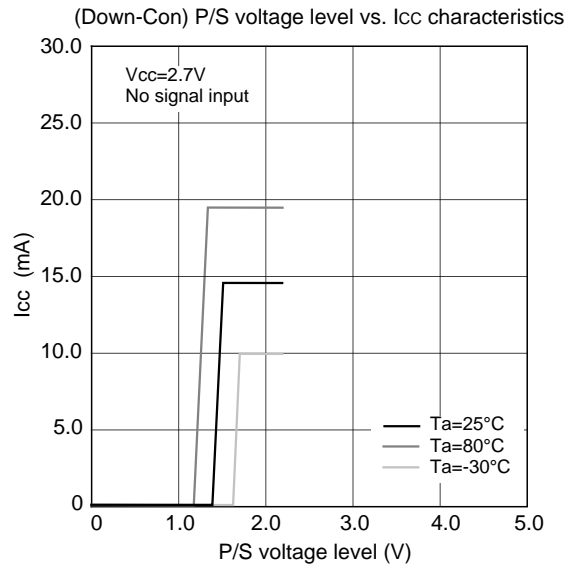
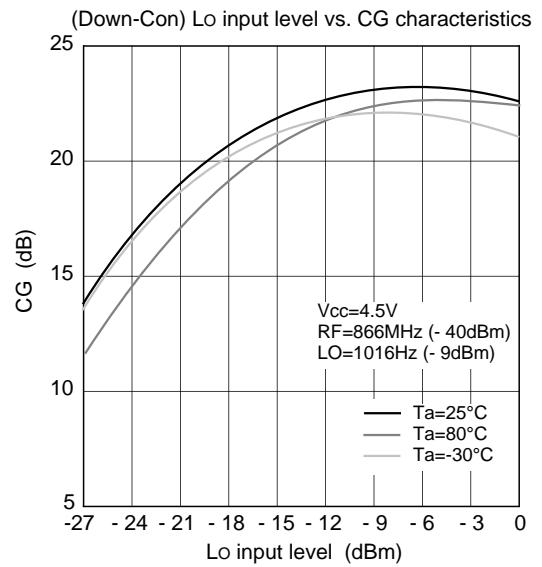
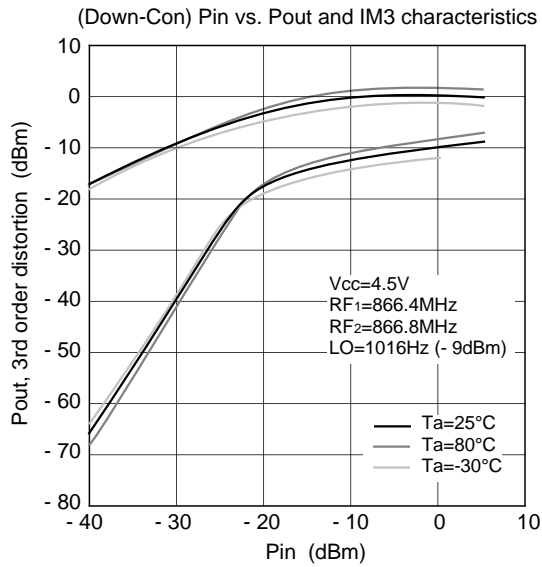

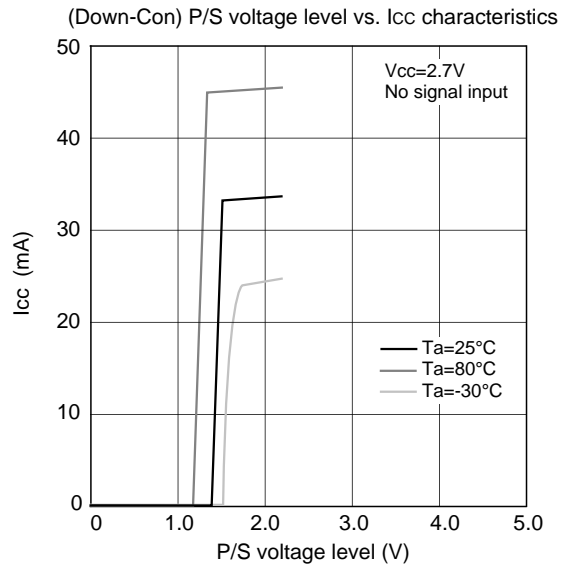
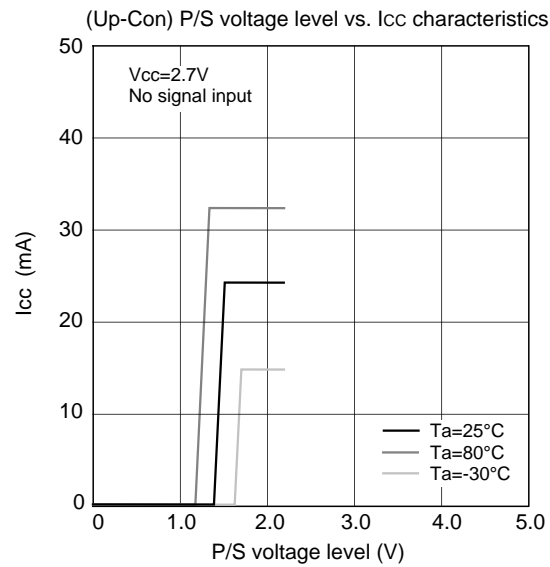
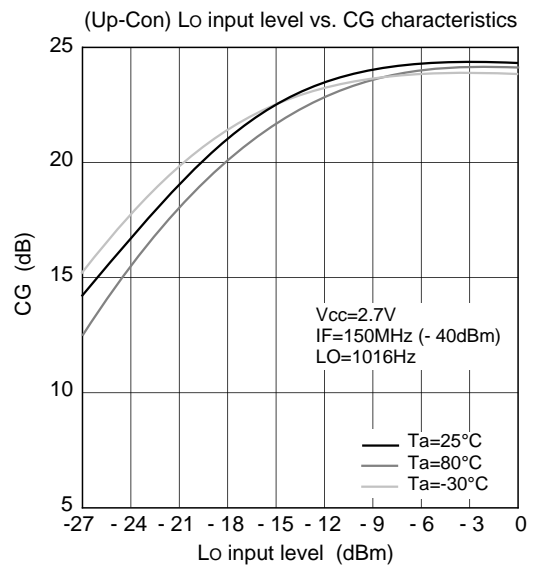
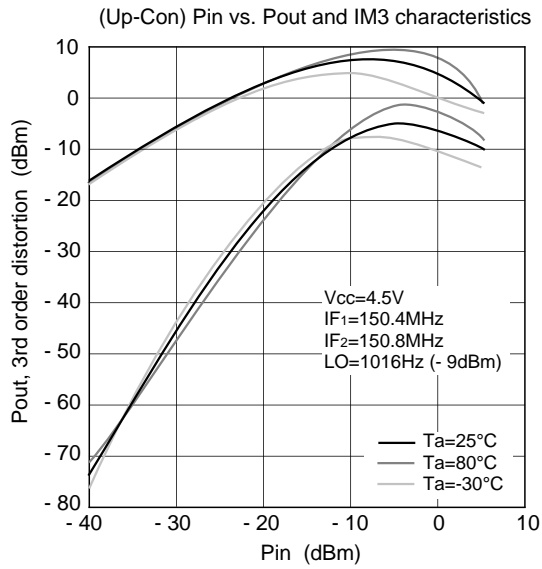
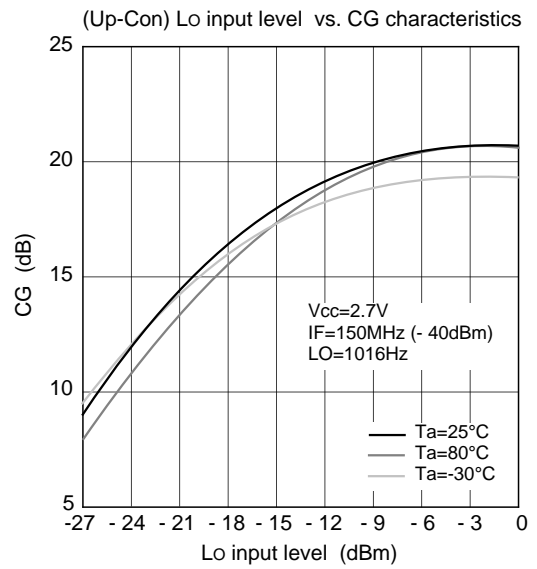
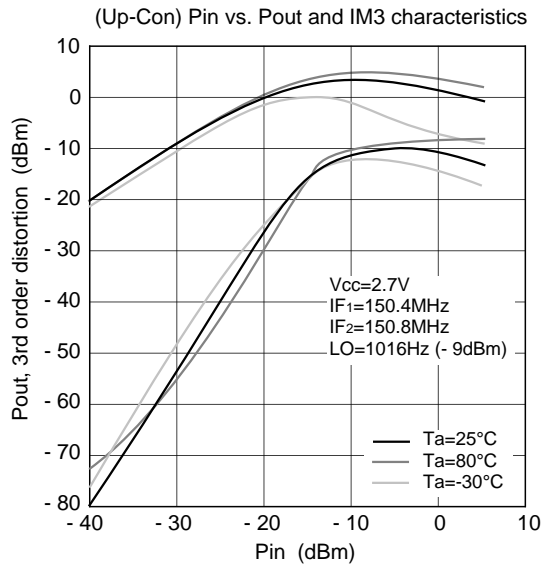

Notes on Operation

- (1) Electrostatic sensitive devices because of the high-frequency process.
- (2) Earth pattern should be as wide as possible and do not increase ground impedance to prevent from the parasitic oscillation.
- (3) Wire the GND pin as short as possible.
- (4) Connect a by-pass capacitor to the VCC pin.

Package Outline Unit : mm

20PIN SSOP (PLASTIC)

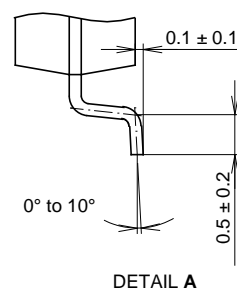
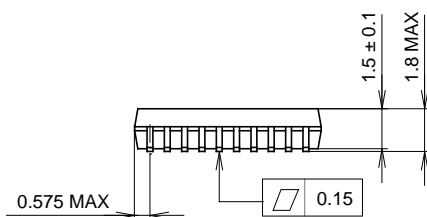
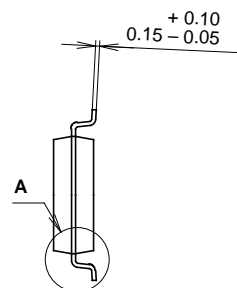
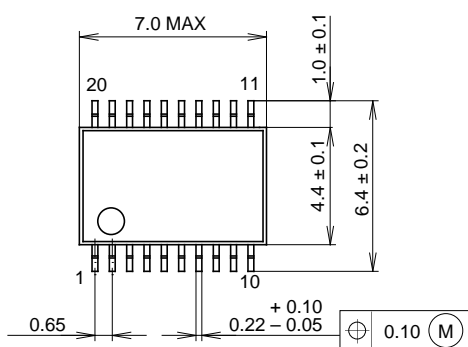

SONY CODE	SSOP-20P-L072
EIAJ CODE	SSOP020-P-0225-BN
JEDEC CODE	—

PACKAGE STRUCTURE

MOLDING COMPOUND	EPOXY / PHENOL RESIN
LEAD TREATMENT	SOLDER PLATING
LEAD MATERIAL	COPPER ALLOY
PACKAGE WEIGHT	0.1g



LittleDiode supplies new, hard to find or obsolete electronic components and semiconductors all over the world.

With over two million different components listed you are sure to find the part you need.

Feel free to visit us today at our online store:

LittleDiode.com

Looking forward to providing you with the best possible service.