

DD Dolby B-C Type Noise Reduction System with Recording Equalizer Amplifier

Description

The CXA1797Q is an audio signal processing LSI designed for use in cassette decks.

Functions include Dolby B-C noise reduction, recording equalizer amplifier, meter circuit (logarithmic), bias control circuit, and playback switching circuit. Serial control of these functions is possible.

Features

- Few external parts
- Serial control of each functions possible
- Dolby B-C noise reduction
- Dolby S noise reduction select switch
- Recording equalizer amplifier
- Recording volume control
- Playback input select switch
- Meter circuit (logarithmic wave detection)
- Bias control circuit (left and right independent)

Applications

Cassette decks

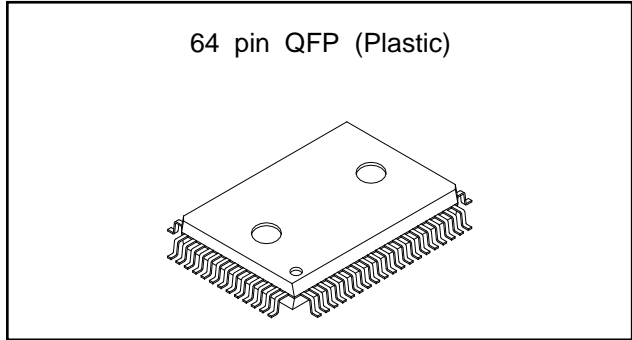

Absolute Maximum Ratings (Ta=25°C)

- Supply voltage

VCC	+12	V
(between VCC and VEE)		
- Operating temperature Topr -20 to +75 °C
- Storage temperature Tstg -65 to +150 °C
- Allowable power dissipation

PD	1.02	W
----	------	---

Recommended Operating Conditions

- Supply voltage

VCC	±5.25 to ±6.0	V
-----	---------------	---

Structure

Bipolar silicon monolithic IC

*This IC is available only to the licensees of Dolby Laboratories Licensing Corporation from whom licensing and applications information may be obtained.

*"Dolby" and the double D symbols are trade marks of Dolby Laboratories Licensing Corporation.

Sony reserves the right to change products and specifications without prior notice. This information does not convey any license by any implication or otherwise under any patents or other right. Application circuits shown, if any, are typical examples illustrating the operation of the devices. Sony cannot assume responsibility for any problems arising out of the use of these circuits.

Block Diagram

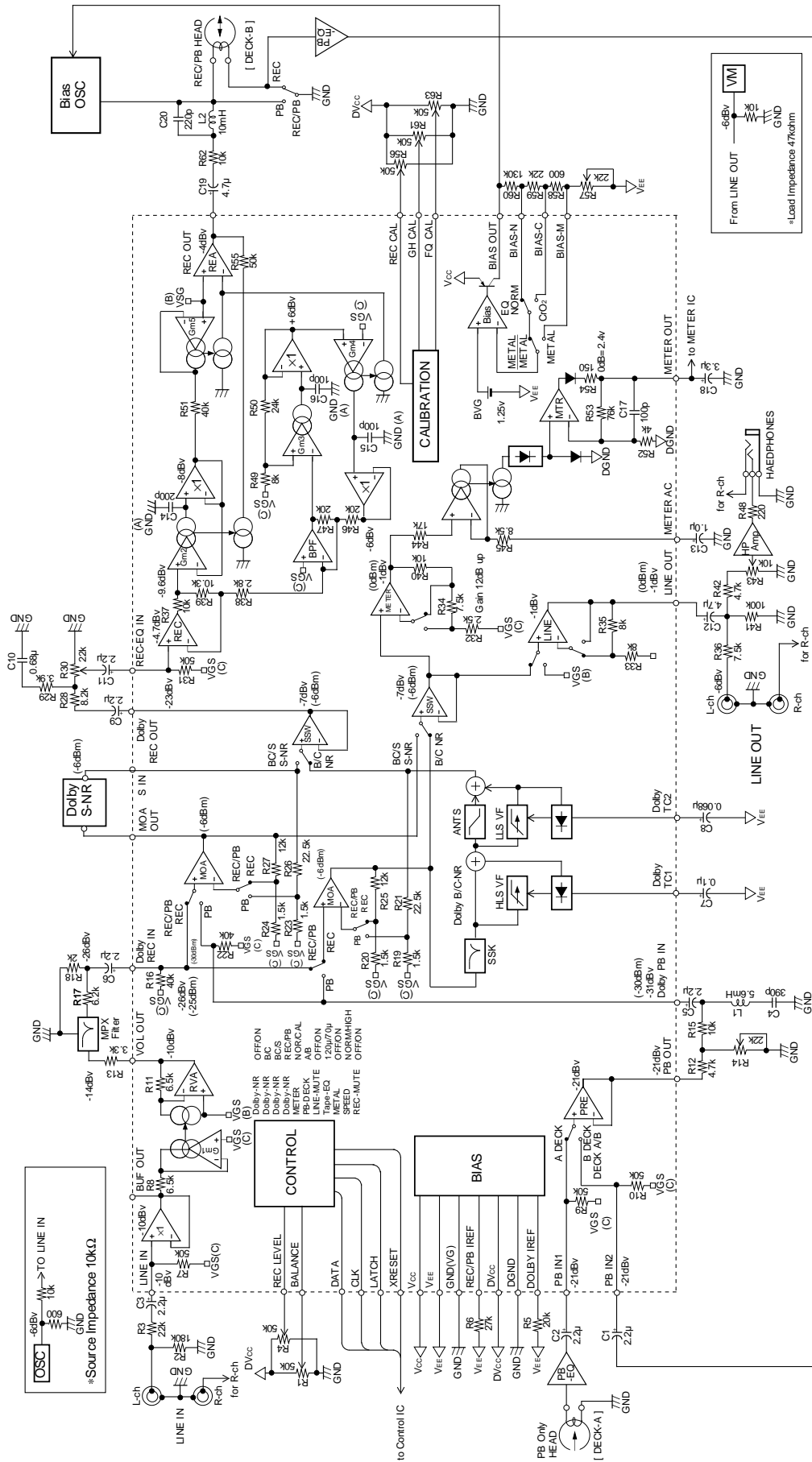

Pin Description (Ta = 25°C, dual-power supply configuration, VCC = 5.5 V, VEE = 5.5 V, DVCC = 5.0 V)

Pin No.	Symbol	Typical pin voltage		I/O	Z (in)	Equivalent circuit	Description
		DC	AC				
1 51	BUFFER OUT1 BUFFER OUT2	0.0V	-10dBv	O	—		Recording volume input buffer output
2 50	VOLUME OUT1 VOLUME OUT2	0.0V	-10dBv	O	—		Recording volume output
3 49	REC IN1 REC IN2	0.0V	-26dBv (-25dBm)	I	40kΩ		Recording input
4 48	DOLBY TCH 1 DOLBY TCH2	VEE +0.4V	—	—	—		Time constant for the HLS

Pin No.	Symbol	Typical pin voltage		I/O	Z (in)	Equivalent circuit	Description
		DC	AC				
5 47	DOLBY TCL1 DOLBY TCL2	V _{EE} +0.9V	—	—	—		Time constant for the LLS
6 46	LINE OUT1 LINE OUT2	0.0V	-1dBv (0dBm)	O	—		Line output
7 45	DOLBY OUT1 DOLBY OUT2	0.0V	-7dBv (-6dBm)	O	—		Dolby S NR output
8 44	DOLBY S IN1 DOLBY S IN2	0.0V	-7dBv (-6dBm)	O	23.5kΩ		Dolby S NR input

Pin No.	Symbol	Typical pin voltage		I/O	Z (in)	Equivalent circuit	Description
		DC	AC				
9 43	REC OUT1 REC OUT2	0.0V	-7dBv (-6dBm)	O	—		Recording output
10 42	REC EQ IN1 REC EQ IN2	0.0V	-23dBv	I	50kΩ		Recording equalizer amplifier input
11 41	METER AC1 METER AC2	0.0V	—	—	—		DC cut capacitance
12 40	REC EQ OUT1 REC EQ OUT2	0.0V	-4dBV	O	—		Recording equalizer amplifier output

Pin No.	Symbol	Typical pin voltage		I/O	Z (in)	Equivalent circuit	Description
		DC	AC				
13 39 14 38 15 37	BIAS MTL1 BIAS MTL2 BIAS CrO1 BIAS CrO2 BIAS NORM1 BIAS NORM2	VEE +1.25V	—	I	—		Recording bias control voltage setting
16 36	BIAS OUT1 BIAS OUT2	—	—	O	—		Recording bias control voltage output
17 18 34	NR TC B/C TC S TC	—	—	I/O	17kΩ		Time constant for selecting NR mode Time constant for selecting B/C mode Time constant for selecting S and B/C modes
19 33	METER OUT1 METER OUT2	2.4V	—	O	—		Meter output (sensitivity: 65 mV/dB)

Pin No.	Symbol	Typical pin voltage		I/O	Z (in)	Equivalent circuit	Description
		DC	AC				
20 32	VEE VCC	-5.5V +5.5V	—	I	—		Negative power supply (Connect to ground when using a single power supply) Positive power supply
21 22 23	XRESET LATCH CLK	—	—	I	—		Reset signal input (active low) Load signal input Clock input
24	DATA	—	—	I	—		Data input
25	DGND	0V	—	I	—		Logic and CAL reference
26	REC LEVEL	0V	—	I	100kΩ		Recording volume adjustment

Pin No.	Symbol	Typical pin voltage		I/O	Z (in)	Equivalent circuit	Description
		DC	AC				
27	REC BALANCE	2.5V	—	I	100kΩ		Recording volume balance adjustment
28 29	GH CAL FQ CAL	2.5V	—	I	54kΩ		High-frequency gain adjustment of recording equalizer amplifier Peak frequency Q adjustment of recording equalizer amplifier
30	REC CAL	2.5V	—	I	54kΩ		Recording equalizer amplifier gain adjustment
31	DVcc	+5.0V	—	I	—		Logic power supply (DREF = 1/2 (DVcc + DGND) is CAL reference.)

Pin No.	Symbol	Typical pin voltage		I/O	Z (in)	Equivalent circuit	Description
		DC	AC				
35	RECMUTE TC	—	—	I/O	17kΩ		Time constant for selecting RECMUTE mode
52 64	LINE IN2 LINE IN1	0.0V	-10dBv	I	50kΩ		Recording volume input
53 63	DOLBY PBIN2 DOLBY PBIN1	0.0V	-31dBv (-30dBm)	I	40kΩ		Playback input
54 62	PBOUT2 PBOUT1	0.0V	-21dBv	O	—		Head select output of playback equalizer amplifier

Pin No.	Symbol	Typical pin voltage		I/O	Z (in)	Equivalent circuit	Description
		DC	AC				
55 56 60 61	PB IN B2 PB IN A2 PB IN A1 PB IN B1	0.0V	-21dBv	I	50kΩ		Head select input of playback equalizer amplifier
57	REC IREF	VEE+ 1.25V	—	—	—		Reference current of recording equalizer amplifier
58	GND	0V	—	—	—		Ground (center capacitance when using a single power supply)
59	DOLBY IREF	VEE+ 1.25V	—	—	—		Reference current

Electrical Characteristics Table

(Ta = 25°C, dual-power supply configuration, VCC = 5.5 V, VEE = 5.5 V, DVCC = 5.0 V)

Block	Item	Conditions	Specifications			Unit
			Min.	Typ.	Max.	
Entire LSI	Operating voltage range 1 (positive/negative dual power supplies)		±5.25	±5.5	±6.0	V
Entire LSI	Operating voltage range 2 (single power supply)		10.5	11.0	12.0	V
Entire LSI	Current consumption (ICC)	No signal, no load, Vcc = ± 5.5 V	25.0	40.0	55.0	mA
Recording equalizer amplifier	Recording equalizer amplifier Recording reference output level NORM-NORM mode	Recording equalizer amplifier reference output level (315 Hz) (This output level is the tape reference 0 dB which generate magnetic flux of 250 nWb/m) All of the recording equalizer amplifier blocks use this level as their reference level.	—	-4.0	—	dBv
Recording equalizer amplifier	Recording equalizer amplifier Recording reference input level NORM-NORM mode	Input level when the reference output level is 315 Hz, -4 dBv (For measurement, input a 315 Hz, -23 dBv signal to the REC EQ IN pins and then measure the output level.)	-24.5	-23.0	-21.5	dBv
Recording equalizer amplifier	NORM-NORM mode REC-EQ frequency response 1 (3 kHz, -20 dB)	NORM-tape, NORM-speed mode Input a 3 kHz signal (-20 dB level down) to the REC EQ IN pin and then measure the relative deviation from NORM-NS, 315 Hz mode.	-1.7	-0.7	-0.3	dB
Recording equalizer amplifier	NORM-NORM mode REC-EQ frequency response 2 (8 kHz, -20 dB)	NORM-tape, NORM-speed mode Input an 8 kHz signal (-20 dB level down) to the REC EQ IN pin and then measure the relative deviation from NORM-NS, 315 Hz mode.	2.9	4.9	6.9	dB
Recording equalizer amplifier	NORM-NORM mode REC-EQ frequency response 3 (12 kHz, -20 dB)	NORM-tape, NORM-speed mode Input a 12 kHz signal (-20 dB level down) from the reference to the REC EQ IN pin and then measure the relative deviation from NORM-NS, 315 Hz mode.	7.8	10.8	13.8	dB
Recording equalizer amplifier	CrO ₂ -NORM mode REC-EQ frequency response 1 (3 kHz, -20 dB)	CrO ₂ -tape, NORM-speed mode Input a 3 kHz signal (-20 dB level down) to the REC EQ IN pin and then measure the relative deviation from NORM-NS, 315 Hz mode.	2.1	3.1	4.1	dB
Recording equalizer amplifier	CrO ₂ -NORM mode REC-EQ frequency response 2 (8 kHz, -20 dB)	CrO ₂ -tape, NORM-speed mode Input an 8 kHz signal (-20 dB level down) to the REC EQ IN pin and then measure the relative deviation from NORM-NS, 315 Hz mode.	4.5	6.5	8.5	dB
Recording equalizer amplifier	CrO ₂ -NORM mode REC-EQ frequency response 3 (12 kHz, -20 dB)	CrO ₂ -tape, NORM-speed mode Input a 12 kHz signal (-20 dB level down) to the REC EQ IN pin and then measure the relative deviation from NORM-NS, 315 Hz mode.	8.0	11.0	14.0	dB
Recording equalizer amplifier	METAL-NORM mode REC-EQ frequency response 1 (3 kHz, -20 dB)	METAL-tape, NORM-speed mode Input a 3 kHz signal (-20 dB level down) to the REC EQ IN pin and then measure the relative deviation from NORM-NS, 315 Hz mode.	3.7	4.7	5.7	dB
Recording equalizer amplifier	METAL-NORM mode REC-EQ frequency response 2 (8 kHz, -20 dB)	METAL-tape, NORM-speed mode Input an 8 kHz signal (-20 dB level down) to the REC EQ IN pin and then measure the relative deviation from NORM-NS, 315 Hz mode.	5.7	7.7	9.7	dB
Recording equalizer amplifier	METAL-NORM mode REC-EQ frequency response 3 (12 kHz, -20 dB)	METAL-tape, NORM-speed mode Input a 12 kHz signal (-20 dB level down) to the REC EQ IN pin and then measure the relative deviation from NORM-NS, 315 Hz mode.	8.4	11.4	14.4	dB

Block	Item	Conditions	Specifications			Unit
			Min.	Typ.	Max.	
Recording equalizer amplifier	NORM-HIGH mode REC-EQ frequency response 1 (5 kHz, -20 dB)	NORM-tape, HIGH-speed mode Input a 5 kHz signal (-20 dB level down) to the REC EQ IN pin and then measure the relative deviation from NORM-NS, 315 Hz mode.	-6.2	-5.2	-4.2	dB
Recording equalizer amplifier	NORM-HIGH mode REC-EQ frequency response 2 (15 kHz, -20 dB)	NORM-tape, HIGH-speed mode Input a 15 kHz signal (-20 dB level down) to the REC EQ IN pin and then measure the relative deviation from NORM-NS, 315 Hz mode.	-0.5	1.5	3.5	dB
Recording equalizer amplifier	NORM-HIGH mode REC-EQ frequency response 3 (20 kHz, -20 dB)	NORM-tape, HIGH-speed mode Input a 20 kHz signal (-20 dB level down) to the REC EQ IN pin and then measure the relative deviation from NORM-NS, 315 Hz mode.	3.0	6.0	9.0	dB
Recording equalizer amplifier	CrO ₂ -HIGH mode REC-EQ frequency response 1 (5 kHz, -20 dB)	CrO ₂ -tape, HIGH-speed mode Input a 5 kHz signal (-20 dB level down) to the REC EQ IN pin and then measure the relative deviation from NORM-NS, 315 Hz mode.	-1.7	-0.7	0.3	dB
Recording equalizer amplifier	CrO ₂ -HIGH mode REC-EQ frequency response 2 (15 kHz, -20 dB)	CrO ₂ -tape, HIGH-speed mode Input a 15 kHz signal (-20 dB level down) to the REC EQ IN pin and then measure the relative deviation from NORM-NS, 315 Hz mode.	1.4	3.4	5.4	dB
Recording equalizer amplifier	CrO ₂ -HIGH mode REC-EQ frequency response 3 (20 kHz, -20 dB)	CrO ₂ -tape, HIGH-speed mode Input a 20 kHz signal (-20 dB level down) to the REC EQ IN pin and then measure the relative deviation from NORM-NS, 315 Hz mode.	4.1	7.1	10.1	dB
Recording equalizer amplifier	METAL-HIGH mode REC-EQ frequency response 1 (5 kHz, -20 dB)	METAL-tape, HIGH-speed mode Input a 5 kHz signal (-20 dB level down) to the REC EQ IN pin and then measure the relative deviation from NORM-NS, 315 Hz mode.	1.0	2.0	3.0	dB
Recording equalizer amplifier	METAL-HIGH mode REC-EQ frequency response 2 (15 kHz, -20 dB)	METAL-tape, HIGH-speed mode Input a 15 kHz signal (-20 dB level down) to the REC EQ IN pin and then measure the relative deviation from NORM-NS, 315 Hz mode.	2.1	4.1	6.1	dB
Recording equalizer amplifier	METAL-HIGH mode REC-EQ frequency response 3 (20 kHz, -20 dB)	METAL-tape, HIGH-speed mode Input a 20 kHz signal (-20 dB level down) to the REC EQ IN pin and then measure the relative deviation from NORM-NS, 315 Hz mode.	4.3	7.3	10.3	dB
Recording equalizer amplifier	NORM-NORM mode Channel crosstalk (1 kHz, +12 dB, 1 kHz BPF)	NORM-tape, NORM-speed mode Alternately input a 1 kHz signal (+12 dB level up) and measure the channel crosstalk. (Use a 1 kHz BPF.)	—	-90.0	-80.0	dB
Recording equalizer amplifier	NORM-NORM mode REC-EQ signal handling (1 kHz, THD = 1%, RL = 2.7 kΩ)	NORM-tape, NORM-speed mode, RL = 2.7 kΩ Input a 1 kHz signal and set the output level so that THD (total harmonic distortion) is 1%. (Measure the distortion of a +9 dB level-up signal.)	9.0	11.0	—	dB
Recording equalizer amplifier	NORM-NORM mode REC-EQ total harmonic distortion (1 kHz, 0.0 dB, RL = 2.7 kΩ)	NORM-tape, NORM-speed mode, RL = 2.7 kΩ Input a 1 kHz, 0 dB (reference input level) signal and measure the distortion. (Measure the distortion as THD + N.)	—	0.02	0.6	%
Recording equalizer amplifier	NORM-NORM mode REC-EQ S/N ratio 1 ("A"-WGT filter)	NORM-tape, NORM-speed mode, Rg = 5.1 kΩ With no signal, measure the noise using the "A"-WGT filter. (The measured value is indicated as the relative value compared to the reference level.)	57.0	67.0	—	dB
Recording equalizer amplifier	NORM-NORM mode Output DC offset voltage (REC OUT pin)	NORM-tape, NORM-speed mode With no signal, measure the DC offset voltage of the REC OUT pin.	-0.5	0.0	0.5	V

Block	Item	Conditions	Specifications			Unit
			Min.	Typ.	Max.	
Recording equalizer amplifier	NORM-NORM mode REC-EQ mute characteristics	NORM-tape, NORM-speed mode, REC-MUTE ON Input a 1 kHz signal (+12 dB level up) and measure the attenuation when REC MUTE is on. (Use a 1 kHz BPF.)	—	-88.0	-80.0	dB
Recording equalizer amplifier	NORM-NORM mode REC-EQ REC-CAL characteristics 1 (REC-CAL = 5.0 V)	NORM-tape, NORM-speed mode, REC-CAL = 5.0 V Input a 1 kHz signal (-20 dB level down) and measure the amount of change compared to when the REC-CAL function is at the standard setting.	4.6	6.1	7.6	dB
Recording equalizer amplifier	NORM-NORM mode REC-EQ REC-CAL characteristics 2 (REC-CAL = 0.0 V)	NORM-tape, NORM-speed mode, REC-CAL = 0.0 V Input a 1 kHz signal (-20 dB level down) and measure the amount of change compared to when the REC-CAL function is at the standard setting.	-8.0	-6.5	-5.0	dB
Recording equalizer amplifier	NORM-NORM mode REC-EQ GH-CAL characteristics 1 (GH-CAL = 5.0 V)	NORM-tape, NORM-speed mode, GH-CAL = 5.0 V Input an 8 kHz signal (-20 dB level down) and measure the amount of change compared to when the GH-CAL function is at the standard setting.	0.7	2.2	3.7	dB
Recording equalizer amplifier	NORM-NORM mode REC-EQ GH-CAL characteristics 2 (GH-CAL = 0.0 V)	NORM-tape, NORM-speed mode, GH-CAL = 0.0 V Input an 8 kHz signal (-20 dB level down) and measure the amount of change compared to when the GH-CAL function is at the standard setting.	-2.8	-1.3	0.2	dB
Recording equalizer amplifier	NORM-NORM mode REC-EQ fQ-CAL characteristics 1-1 (fQ-CAL = 5.0 V)	NORM-tape, NORM-speed mode, fQ-CAL = 5.0 V Input an 8 kHz signal (-20 dB level down) and measure the amount of change compared to when the fQ-CAL function is at the standard setting.	-5.9	-4.4	-2.9	dB
Recording equalizer amplifier	NORM-NORM mode REC-EQ fQ-CAL characteristics 1-2 (fQ-CAL = 5.0 V)	NORM-tape, NORM-speed mode, fQ-CAL = 5.0 V Input a 12 kHz signal (-20 dB level down) and measure the amount of change compared to when the fQ-CAL function is at the standard setting.	-8.4	-6.9	-5.4	dB
Recording equalizer amplifier	NORM-NORM mode REC-EQ fQ-CAL characteristics 2-1 (fQ-CAL = 0.0 V)	NORM-tape, NORM-speed mode, fQ-CAL = 0.0 V Input an 8 kHz signal (-20 dB level down) and measure the amount of change compared to when the fQ-CAL function is at the standard setting.	5.0	6.5	8.0	dB
Recording equalizer amplifier	NORM-NORM mode REC-EQ fQ-CAL characteristics 2-2 (fQ-CAL = 0.0 V)	NORM-tape, NORM-speed mode, fQ-CAL = 0.0 V Input a 12 kHz signal (-20 dB level down) and measure the amount of change compared to when the fQ-CAL function is at the standard setting.	4.9	6.4	7.9	dB
Recording volume	Recording volume amplifier Recording volume characteristics 1 (REC-VOL = 5.0 V, REC-BAL = 2.5 V)	REC-VOL = 5.0 V, REC-BAL = 2.5 V Input a 1 kHz, -10 dBV signal to the LINE IN pin and measure the full gain of the recording volume amplifier.	7.9	9.4	10.9	dB
Recording volume	Recording volume amplifier Recording volume characteristics 2 (REC-VOL = 2.0 V, REC-BAL = 2.5 V)	REC-VOL = 2.0 V, REC-BAL = 2.5 V Input a 1 kHz, -10 dBV signal to the LINE IN pin and measure the attenuation of the recording volume amplifier.	-10.2	-8.7	-7.2	dB
Recording volume	Recording volume amplifier Recording volume attenuation (REC-VOL = 0.0 V, REC-BAL = 2.5 V)	REC-VOL = 0.0 V, REC-BAL = 2.5 V Input a 1 kHz, +2 dBV signal and measure the maximum volume attenuation of the recording volume amplifier. (Use a 1 kHz BPF.)	—	-86.0	-80.0	dB
Recording volume	Recording volume amplifier REC-VOL signal handling (1 kHz, THD = 1%, RL = 2.7 kΩ)	REC-VOL = 2.0 V, REC-BAL = 2.5 V, RL = 2.7 kΩ Input a 1 kHz signal and set the input level so that the THD is 1%. (Measure the distortion when the output is +2 dBV.)	12.0	12.5	—	dB
Recording volume	Recording volume amplifier REC-VOL total harmonic distortion (1 kHz, -10.0 dBV, RL = 2.7 kΩ)	REC-VOL = 2.0 V, REC-BAL = 2.5 V, RL = 2.7 kΩ Input a 1 kHz, -10 dBV signal (reference input level) and measure the distortion. (Measure the distortion as THD + N.)	—	0.15	0.5	%

Block	Item	Conditions	Specifications			Unit
			Min.	Typ.	Max.	
Recording volume	Recording volume amplifier REC-VOL S/N ratio 1 ("A"-WGT filter)	REC-VOL = 5.0 V, REC-BAL = 2.5 V With no signal, measure the noise using an "A"-WGT filter. (The measured value is indicated as the relative value compared to the full-gain level.)	80.0	83.0	—	dB
Recording volume	Recording volume amplifier Output DC offset voltage (VOL OUT pin)	REC-VOL = 5.0 V, REC-BAL = 2.5 V With no signal, measure the DC offset voltage of the VOL OUT pin.	-0.15	0.0	0.15	V
Recording volume	Recording volume amplifier REC-VOL balance characteristics 1 (REC-VOL = 5.0 V, REC-BAL = 0.0 V)	REC-VOL = 5.0 V, REC-BAL = 0.0 V (1 kHz BPF) Input a 1 kHz, +2 dBv signal and measure the attenuation of VOL OUT 1. (Input -10 dBv and confirm that there is no attenuation at VOL OUT 2.)	—	-96.0	-60.0	dB
Recording volume	Recording volume amplifier REC-VOL balance characteristics 2 (REC-VOL = 5.0 V, REC-BAL = 5.0 V)	REC-VOL = 5.0 V, REC-BAL = 5.0 V (1 kHz BPF) Input -10 dBv and confirm that there is no attenuation at VOL OUT 1. (Input a 1 kHz, +2 dBv signal and measure the attenuation of VOL OUT 2.)	-1.0	0.0	1.0	dB
Recording volume	Recording volume amplifier Channel crosstalk (REC-VOL = 5.0 V, REC BAL = 2.5 V)	REC-VOL = 5.0 V, REC-BAL = 2.5 V Alternately input a 1 kHz, +2 dBv signal, and measure the channel crosstalk. (Use a 1 kHz BPF.)	—	-98.0	-80.0	dB
Recording volume	Input buffer gain (1 kHz, -10.0 dBv)	Input a 1 kHz, -10 dBv signal to the LINE IN pin and measure the gain at the BUF OUT pin.	-1.0	0.0	1.0	dB
Line amplifier	Line amplifier gain (1 kHz, -30 dBm)	PB mode Input a 1 kHz, -30 dBm signal to the DOLBY PBIN pin and measure the output level at the LINE OUT pins.	-1.0	0.0	1.0	dBm
Line amplifier	Line amplifier Signal handling (1 kHz, THD = 1%)	PB mode Input a 1 kHz signal and set the output level so that the THD is 1%.	12.0	12.6	—	dB
Line amplifier	Line amplifier Line amplifier total harmonic distortion (1 kHz, -30 dBm)	PB mode Input a 1 kHz, -30 dBm signal (reference input level) and measure the distortion. (Measure the distortion as THD + N.)	—	0.02	0.5	%
Line amplifier	Line amplifier Line amplifier S/N ratio ("A"-WGT filter)	PB mode With no signal, measure the noise using an "A"-WGT filter. (The measured value is indicated as the relative value compared to the reference level.)	80.0	82.5	—	dB
Line amplifier	Line amplifier Output DC offset voltage (LINE OUT pin)	REC mode With no signal, measure the DC offset voltage of the LINE OUT pin.	-0.2	-0.1	0.2	V
Line amplifier	Line amplifier MUTE mode characteristics (1 kHz BPF)	PB, MUTE mode Input a 1 kHz, -18 dBm signal to the DOLBY PB IN pin and measure the attenuation when LINE MUTE is on. (Use a 1 kHz BPF.)	—	-107.0	-80.0	dB
Line amplifier	Line amplifier Channel crosstalk (1 kHz, -14.0 dBv, 1 kHz BPF)	PB mode Alternately input a 1 kHz, -18 dBm signal to the DOLBY PB IN pin and measure the channel crosstalk. (Use a 1 kHz BPF.)	—	-94.0	-80.0	dB
Level meter	Level meter amplifier Level meter characteristics 1 (REC IN = 1 kHz, -26 dBv)	METER ON, REC mode Input a 1 kHz, -26 dBv signal to the REC IN pin and measure the output DC voltage at the METER pin.	2.5	2.8	3.1	V

Block	Item	Conditions	Specifications			Unit
			Min.	Typ.	Max.	
Level meter	Level meter amplifier Level meter characteristics 2 (REC IN = 1 kHz, -22 dBv)	METER ON, REC mode Input a 1 kHz, -22 dBv (+4 dB level up) signal to the REC IN pin and measure the output DC voltage at the METER pin.	2.75	3.05	3.35	V
Level meter	Level meter amplifier Level meter characteristics 3 (REC IN = 1 kHz, -36 dBv)	METER ON, REC mode Input a 1 kHz, -36 dBv (-10 dB level down) signal to the REC IN pin and measure the output DC voltage at the METER pin.	1.85	2.15	2.45	V
Level meter	Level meter amplifier Level meter characteristics 4 (REC IN = 1 kHz, -46 dBv)	METER ON, REC mode Input a 1 kHz, -46 dBv (-20 dB level down) signal to the REC IN pin and measure the output DC voltage at the METER pin.	1.2	1.5	1.8	V
Level meter	Level meter amplifier Level meter characteristics 5 (REC IN = no signal)	METER ON, REC mode With no signal, measure the DC offset voltage at the METER pin.	—	0.01	0.1	V
Level meter	Level meter amplifier Level meter CAL characteristics (REC IN = 1 kHz, -58 dBv)	CAL ON, REC mode Input a 1 kHz, -58 dBv (-32 dB level down) signal to the REC IN pin and measure the output DC voltage at the METER pin.	1.2	1.5	1.8	V
Playback input switch	Playback input switch gain (PB IN = 1 kHz, -21 dBv)	Input a 1 kHz, -21 dBv signal to the PB IN pin and measure the level.	-22.0	-21.0	-20.0	dBv
Playback input switch	Playback input switch Signal handling (1 kHz, THD = 1%)	A-DECK mode Input a 1 kHz signal to the PB IN1 pin and set the output level so that the THD is 1%.	12.0	30.0	—	dB
Playback input switch	Playback input switch Total harmonic distortion (1 kHz, -21 dBv)	A-DECK mode Input a 1 kHz, -10 dBv signal (input reference level) to the PB IN1 pin and measure the distortion. (Measure the distortion as THD + N.)	—	0.02	0.5	%
Playback input switch	Playback input switch S/N ratio ("A"-WGT filter)	A-DECK mode With no signal, measure the noise using the "A"-WGT filter. (The measured value is indicated as the relative value compared to the reference level.)	80.0	84.0	—	dB
Playback input switch	Playback input switch A/B DECK crosstalk A-DECK mode	A-DECK mode Input a 1 kHz, -9 dBv (+12 dB level up) signal to the B-DECK side and measure the A/B-DECK crosstalk. (Use a 1 kHz BPF.)	—	-89.0	-80.0	dB
Playback input switch	Playback input switch Output DC offset voltage (PB OUT pin)	A-DECK mode With no signal, measure the DC offset voltage of the PB OUT pin.	-0.2	0.0	0.2	V
BIAS SW	Bias maximum output voltage	BIAS ON mode, RL = 4.7 kΩ Measure the output DC voltage of the BIAS OUT pin.	4.8	5.0	—	V
BIAS SW	NORMAL mode Bias output voltage 1	NORMAL mode Set the external feedback resistance to 56 kΩ, 11 kΩ, 11 kΩ, and 11 kΩ, and measure the output DC voltage of the BIAS OUT pin.	-2.4	-2.2	-2.0	V
BIAS SW	CrO ₂ mode Bias output voltage 2	CrO ₂ mode Set the external feedback resistance to 56 kΩ, 11 kΩ, 11 kΩ, and 11 kΩ, and measure the output DC voltage of the BIAS OUT pin.	-0.75	-0.5	-0.25	V
BIAS SW	METAL mode Bias output voltage 3	METAL mode Set the external feedback resistance to 56 kΩ, 11 kΩ, 11 kΩ, and 11 kΩ, and measure the output DC voltage of the BIAS OUT pin.	4.2	4.5	4.8	V

Block	Item	Conditions	Specifications			Unit
			Min.	Typ.	Max.	
DOLBY	Dolby reference level	Value at the Dolby reference level of the REC OUT pin	—	-6.0	—	dBm
DOLBY	REC mode REC IN level	REC mode, NR off, f = 1 kHz Input a signal to the REC IN pin and measure the level at which the level of the DOLBY OUT pin reaches -6 dBm.	-26.0	-25.0	-24.0	dBm
DOLBY	PB mode PB IN level	PB mode, NR off, f = 1 kHz Input a signal to the NR PB IN pin and measure the level at which the level of the DOLBY OUT pin reaches -6 dBm.	-31.0	-30.0	-29.0	dBm
DOLBY	B type encoding Boost characteristics 1	REC, Dolby B mode Input a 500 Hz, -25 dB signal to the REC IN pin and measure the boost at the REC OUT pin.	1.4	2.9	4.4	dB
DOLBY	B type encoding Boost characteristics 2	REC, Dolby B mode Input a 5 kHz, -25 dB signal to the REC IN pin and measure the boost at the REC OUT pin.	3.9	5.4	6.9	dB
DOLBY	B type encoding Boost characteristics 3	REC, Dolby B mode Input a 10 kHz, -40 dB signal to the REC IN pin and measure the boost at the REC OUT pin.	9.7	10.4	11.4	dB
DOLBY	B type encoding Boost characteristics 4	REC, Dolby B mode Input a 10 kHz, 0 dB signal to the REC IN pin and measure the boost at the REC OUT pin.	-1.1	0.4	1.9	dB
DOLBY	C type encoding Boost characteristics 1	REC, Dolby C mode Input a 500 Hz, -60 dB signal to the REC IN pin and measure the boost at the REC OUT pin.	14.2	16.2	18.2	dB
DOLBY	C type encoding Boost characteristics 2	REC, Dolby C mode Input a 500 Hz, -25 dB signal to the REC IN pin and measure the boost at the REC OUT pin.	7.2	9.2	11.2	dB
DOLBY	C type encoding Boost characteristics 3	REC, Dolby C mode Input a 2 kHz, -60 dB signal to the REC IN pin and measure the boost at the REC OUT pin.	18.7	20.7	22.7	dB
DOLBY	C type encoding Boost characteristics 4	REC, Dolby C mode Input a 2 kHz, -25 dB signal to the REC IN pin and measure the boost at the REC OUT pin.	5.4	7.4	9.4	dB
DOLBY	C type encoding Boost characteristics 5	REC, Dolby C mode Input a 5 kHz, -25 dB signal to the REC IN pin and measure the boost at the REC OUT pin.	3.5	5.5	7.5	dB
DOLBY	C type encoding Boost characteristics 6	REC, Dolby C mode Input a 10 kHz, 0 dB signal to the REC IN pin and measure the boost at the REC OUT pin.	-5.5	-3.5	-1.5	dB
DOLBY	PB mode Frequency response	PB, Dolby off mode Input a 20 kHz, -30 dBm signal to the NR PB IN pin and measure the output at the REC OUT pin.	-7.5	-6.0	-4.5	dBm
DOLBY	REC mode Signal handling	REC, NR off mode Input a 1 kHz signal and set the output level so that the THD is 1%. (Measure the distortion using a signal boosted 13.5 dB from the reference.)	13.5	15.8	—	dB
DOLBY	NR OFF total harmonic distortion	REC, NR off mode Input a 1 kHz, +10 dB signal to the REC IN pin and measure the distortion. (Measure the distortion as THD + N.)	—	0.02	0.15	%
DOLBY	Dolby B total harmonic distortion	REC, Dolby B mode Input a 1 kHz, +10 dB signal to the REC IN pin and measure the distortion. (Measure the distortion as THD + N.)	—	0.04	0.2	%

Block	Item	Conditions	Specifications			Unit
			Min.	Typ.	Max.	
DOLBY	Dolby C total harmonic distortion	REC, Dolby C mode Input a 1 kHz, +10 dB signal to the REC IN pin and measure the distortion. (Measure the distortion as THD + N.)	—	0.08	0.3	%
DOLBY	REC mode Dolby C S/N ratio	REC, Dolby C mode, $R_g = 5.1 \text{ k}\Omega$ With no signal, measure the noise using the CCIR/ARM filter. (The measured value is indicated as the relative value compared to the DOLBY OUT level.)	60.0	61.0	—	dB
DOLBY	PB mode Recording → playback crosstalk	PB, NR off mode Input a 1 kHz, +10 dB signal to the REC IN pin and measure the REC → PB crosstalk. (Use a 1 kHz BPF.)	—	-79	-70	dB
DOLBY	REC mode Playback → recording crosstalk	REC, NR off mode Input a 1 kHz, +10 dB signal to the NR PB IN pin and measure the PB → REC crosstalk. (Use a 1 kHz BPF.)	—	-90	-70	dB
DOLBY	REC mode Channel crosstalk	PB, NR off mode Input a 1 kHz, +10 dB signal to the REC IN pin and measure the channel crosstalk. (Use a 1 kHz BPF.)	—	-84	-65	dB
DOLBY	PB mode Channel crosstalk	PB, NR off mode Input a 1 kHz, +10 dB signal to the NR PB IN pin and measure the channel crosstalk. (Use a 1 kHz BPF.)	—	-85	-65	dB
DOLBY	REC mode Output DC offset voltage 1 (REC OUT pin)	REC mode, NR off → B type With no signal, measure the deviation in the output DC offset voltage at the REC OUT pin when switching from NR off mode to B type mode.	-100	—	100	mV
DOLBY	REC mode Output DC offset voltage 2 (REC OUT pin)	REC mode, NR off → C type With no signal, measure the deviation in the output DC offset voltage at the REC OUT pin when switching from NR off mode to C type mode.	-100	—	100	mV
Logic	High level input voltage	V_{iH}	3.5	—	—	V
Logic	Low level input voltage	V_{iL}	—	—	1.5	V
Logic	Clock frequency	fck	—	—	500	kHz
Logic	Clock pulse width	tw	1	—	—	μs
Logic	Data setup time	$t_{su}(\text{DATA} \rightarrow \text{CLK})$	1	—	—	μs
Logic	Data hold time	$t_{H}(\text{CLK} \rightarrow \text{DATA})$	1	—	—	μs
Logic	Latch pulse width	tw(DATA)	1	—	—	μs
Logic	Latch setup time	$t_{s}(\text{LATCH} \rightarrow \text{DATA})$	1	—	—	μs
Logic	Latch hold time	$t_{H}(\text{CLK} \rightarrow \text{LATCH})$	1	—	—	μs
Logic	Reset pulse width	tw(XRST)	1	—	—	μs

Electrical Characteristics Measurement Circuit

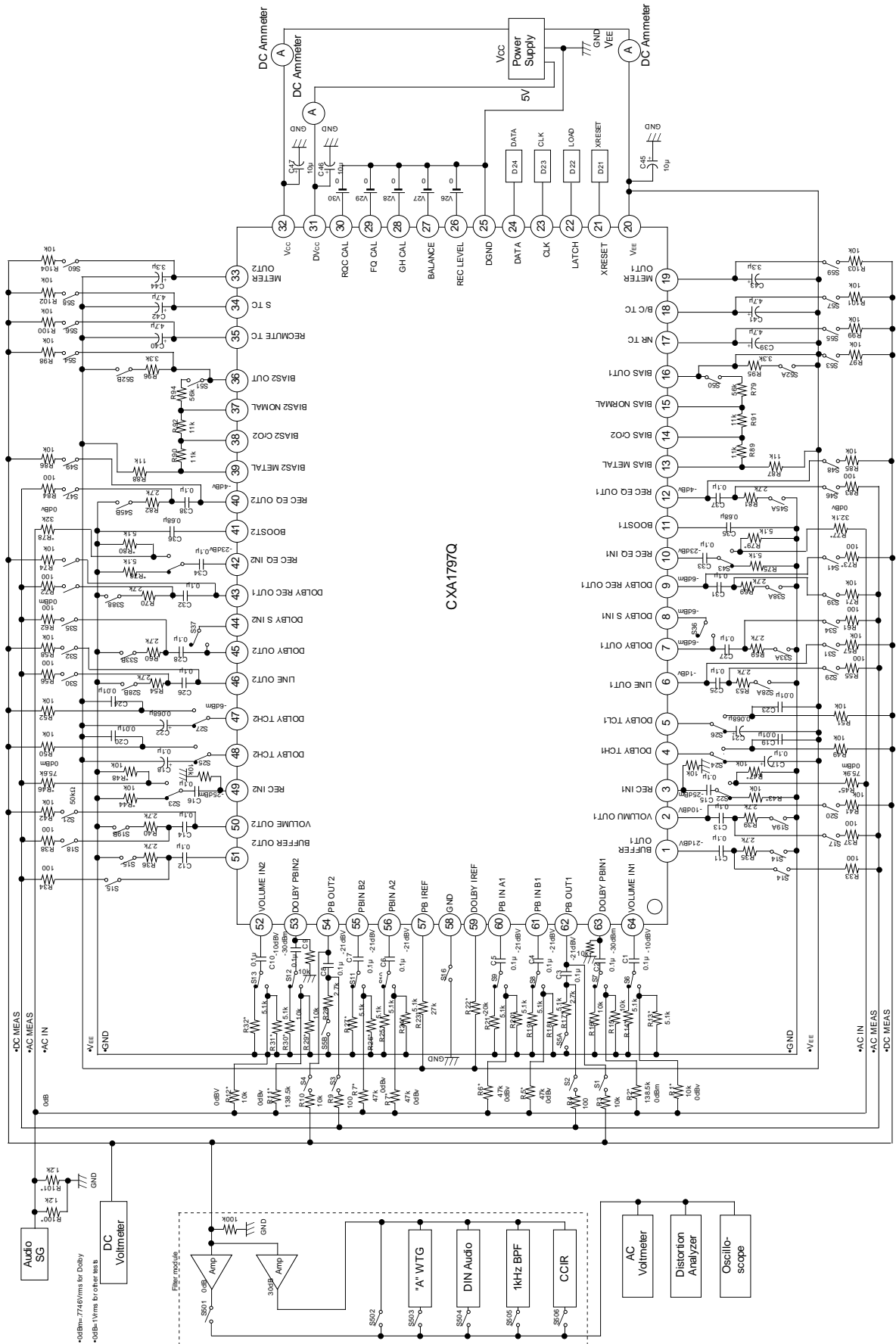

Description of Operation

1. Logic Usage

The CXA1797Q is controlled by 11-bit serial data.

	Name	Function (DATA 1) ^(Note 2)	Function (DATA 0)
D1	SPEED	NORM	HIGH
D2	METAL	METAL OFF	METAL ON
D3	EQ	120μs	70μs
D4	A/B	DECK A	DECK B
D5	METER	METER GAIN NORM	METER GAIN HIGH (+12dB)
D6	PB/REC	PB MODE	REC MODE
D7	LMUTE	LINE MUTE ON	LINE MUTE OFF
D8	RMUTE	REC MUTE ON	REC MUTE OFF
D9 ^(Note 1)	BC/S	DOLBY NR B or C	DOLBY NR S
D10	B/C	DOLBY NR B	DOLBY NR C
D11	NR ON/OFF	DOLBY NR OFF	DOLBY NR ON

Note 1) S mode takes precedence over other noise reduction modes. (When turning noise reduction off, select BC mode.)

Note 2) All data is initialized to "1" when a reset is executed.

2. Serial Data Format

An overview of the serial data format is shown below.

When using CLK and LATCH as normal high:

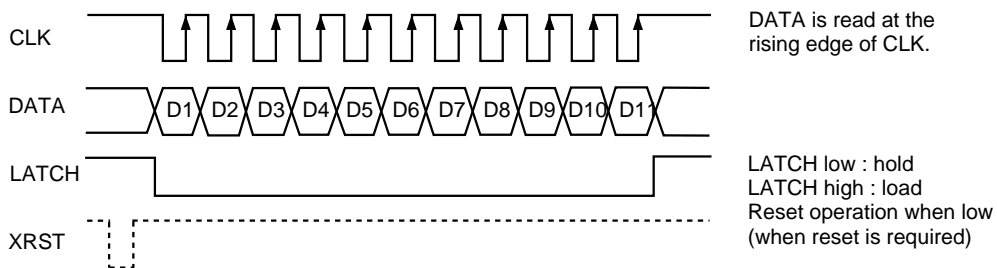

When using CLK and LATCH as normal low ^(Note 3):

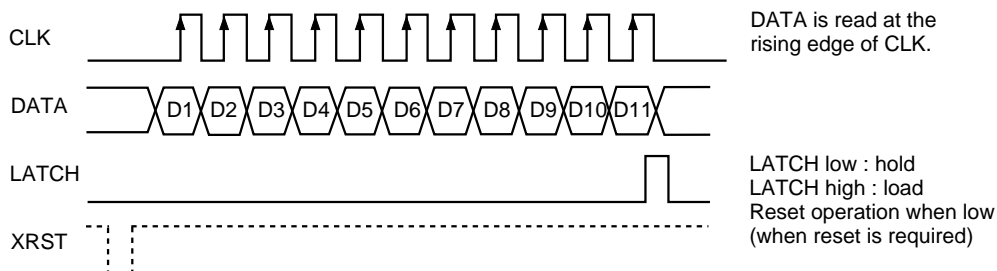

Note 3) In this instance, have the LATCH signal rise while CLK is high.

3. Timing Chart of 11-bit Serial Data Interface

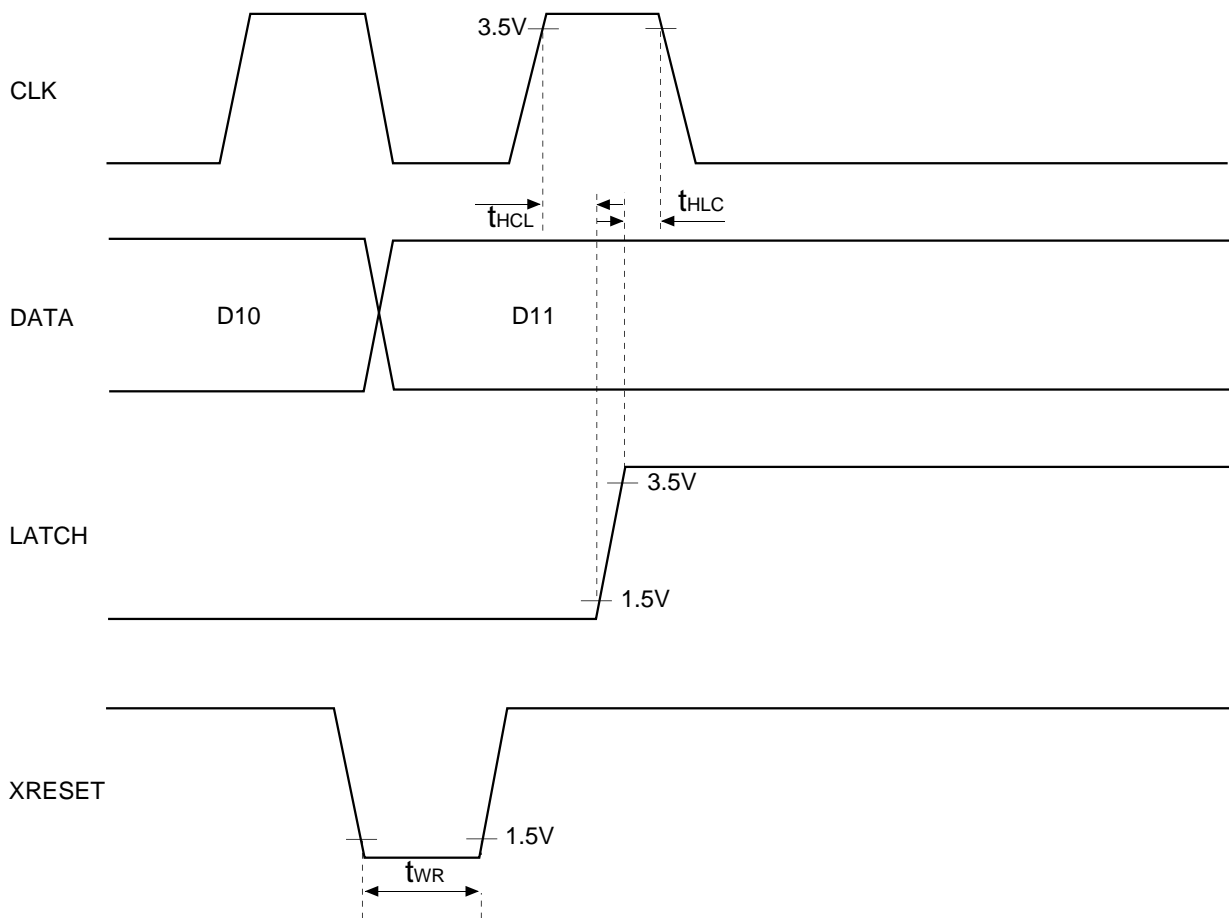
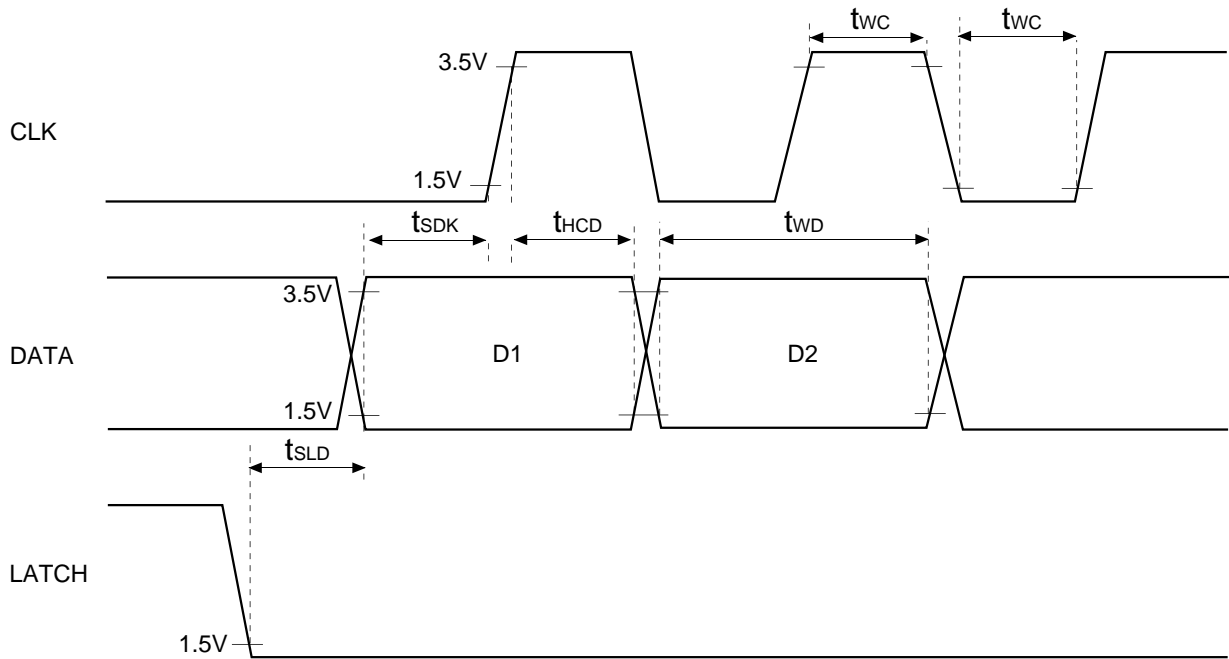

4. Control pin usage

1) REC VOL

Connect a 50 k Ω variable resistor to this pin; this pin controls the electronic volume according to the voltage (between DVCC and DGND) applied to this pin.

(Although other resistances and voltages can be used, the gain when the volume is at the center will differ.)

2) REC BAL

This pin controls the electronic volume balance.

(Both channel sounds are output when voltage of $(DVCC + DGND)/2$ is applied to this pin or when it is open. When DVCC voltage is applied, only the CH1 sound is output, and when DGND voltage is applied, only the CH2 sound is output.)

3) REC CAL

This pin adjusts the overall gain for the recording equalizer amplifier. (The gain is at the center when voltage of $(DVCC + DGND)/2$ is applied to this pin or when it is open.)

4) FQ CAL

This pin adjusts the high-frequency peak Q value for the recording equalizer amplifier. (FP and GP also change.)

(The value is at the center when voltage of $(DVCC + DGND)/2$ is applied to this pin or when it is open.)

5) GH CAL

This pin adjusts the middle/high frequency gain for the recording equalizer amplifier.

(The gain is at the center when voltage of $(DVCC + DGND)/2$ is applied to this pin or when it is open.)

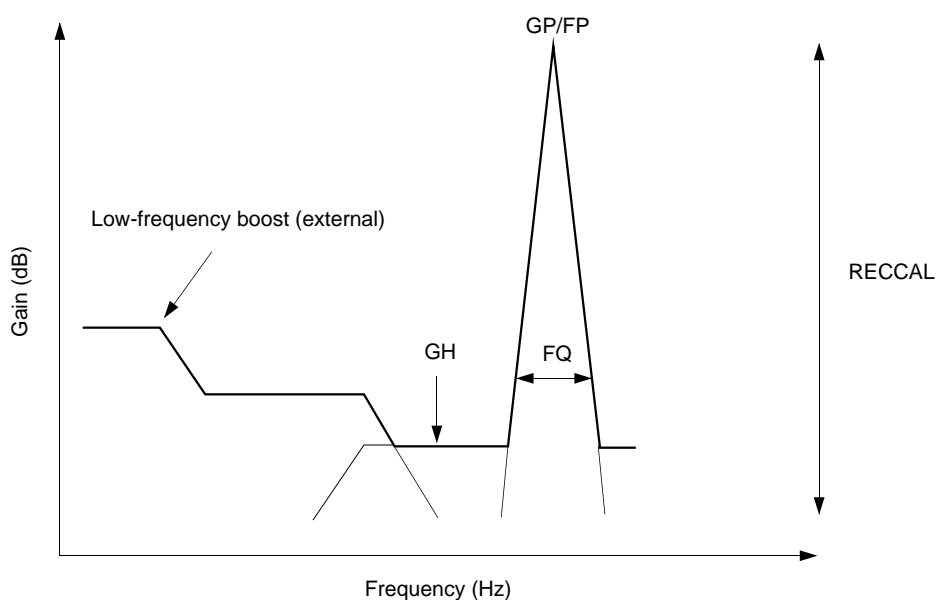

5. NR TC, BC TC, STC, RMUTE TC

These time constants are set in order to prevent the generation of a popping noise when one of the switches operates. In addition, these functions can be controlled directly by applying voltage from an external source. (In this case, the capability to drive 17 kΩ impedance is required.)

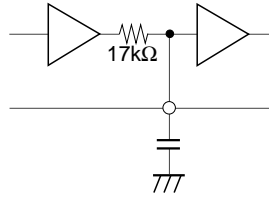

6. Meter circuit

The CXA1797Q meter circuit is a logarithmic detector.

The circuit has a sensitivity of 65 mV/dB and is designed to generate 2.8 V when the reference signal is input.

This circuit has the temperature characteristics depend on $V_t (= KT/q)$.

As a result, in order to satisfy the specifications, sufficient warmup time is required.

If METER GAIN is set to HIGH mode, the sensitivity is increased by 12 dB.

The METER AC pin is used to detect only the AC component, the low-frequency cut-off is determined by the 8.5 kΩ internal resistance and the capacitance connected to this pin.

(With approximately 20 kHz at 1 μF, the high-frequency cut-off is fixed at 20 kHz.)

7. Bias circuit

This circuit generates the DC voltage that controls the bias oscillator.

The BIASOUT voltage is specified so that voltage equal to the internal reference voltage ($V_{EE} + 1.25 V$) is generated at a pin selected according to the tape mode (BIAS N, BIAS C, or BIAS M).

The BIASOUT pin is provided with a protective resistor of 147 Ω. Take into account the corresponding voltage drop when the load current is high.

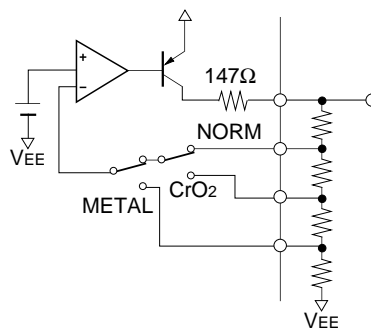

REC EQ frequency response

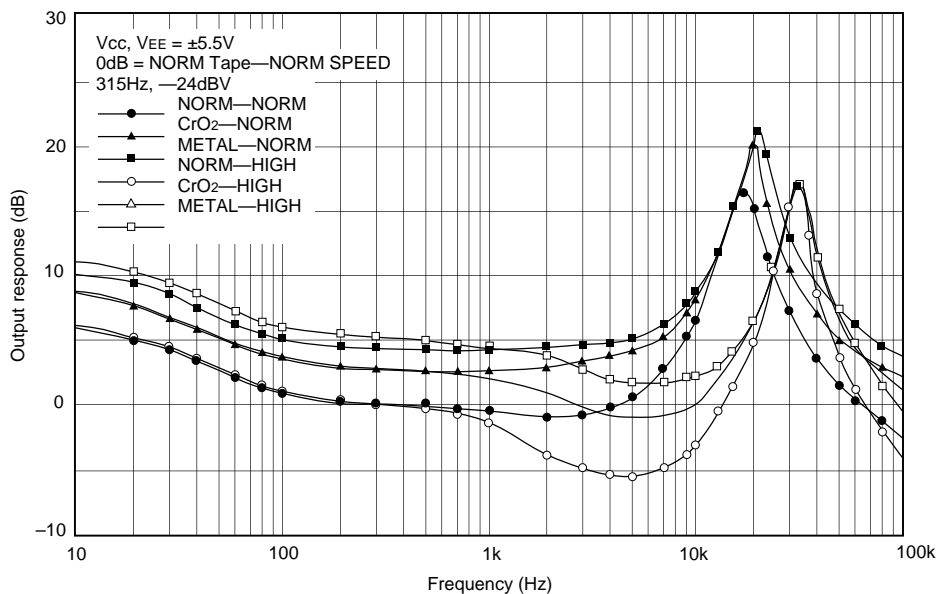

REC EQ total harmonic distortion

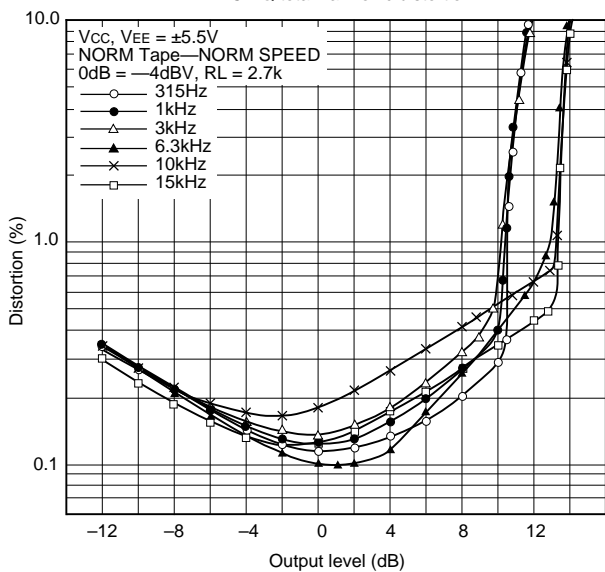

REC EQ load characteristics

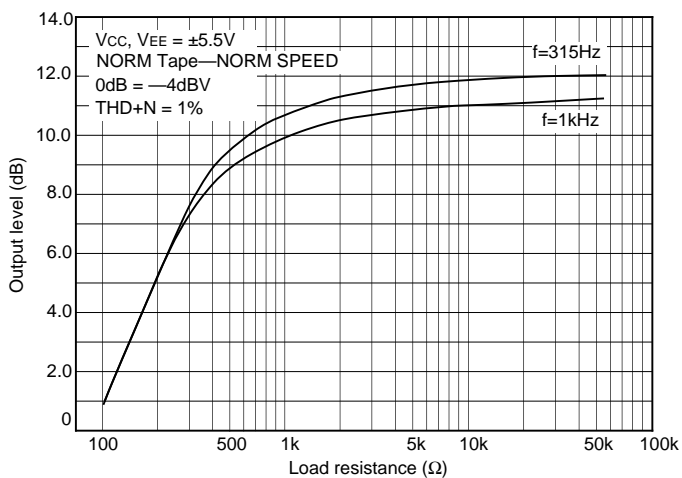

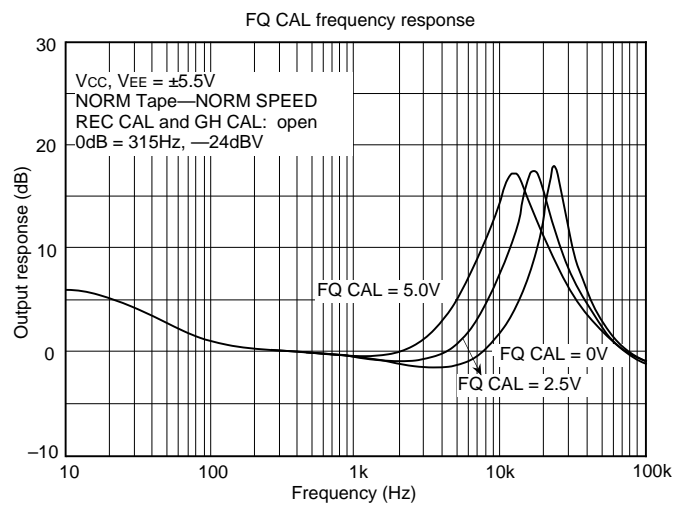
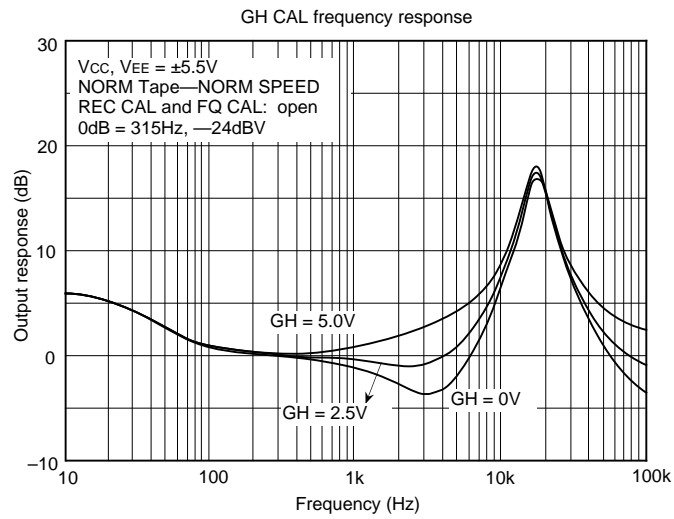
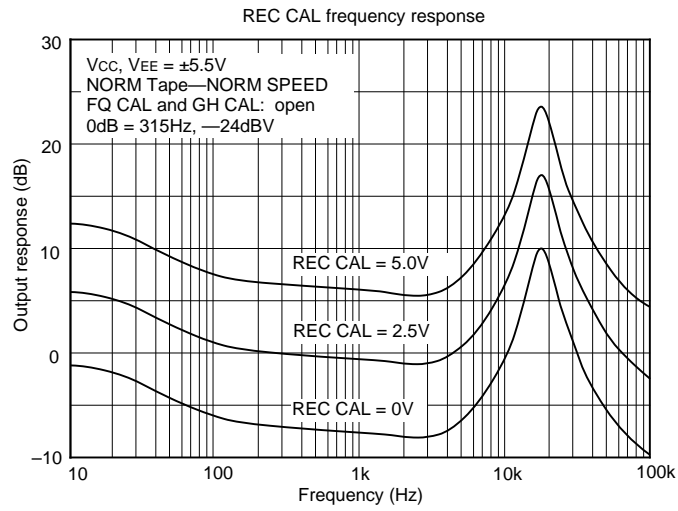

Output level vs. REC CAL voltage

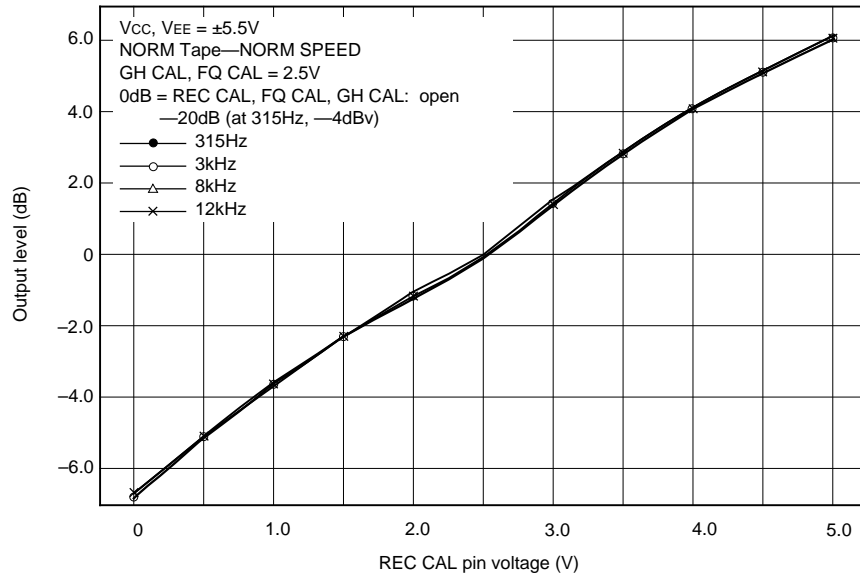

Output level vs. GH CAL voltage

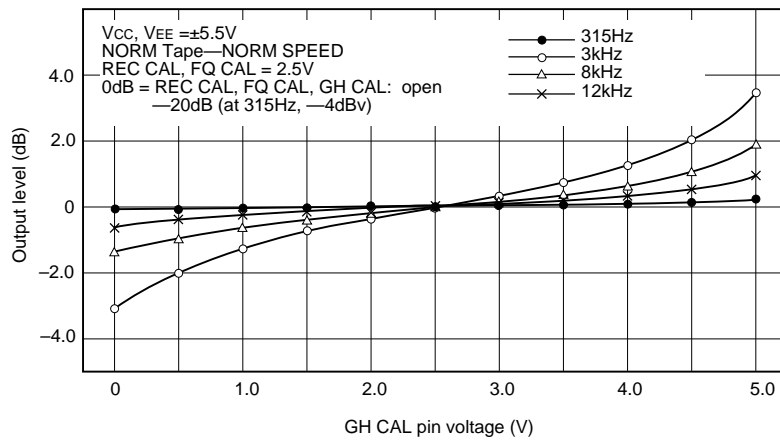

Output level vs. FQ CAL voltage

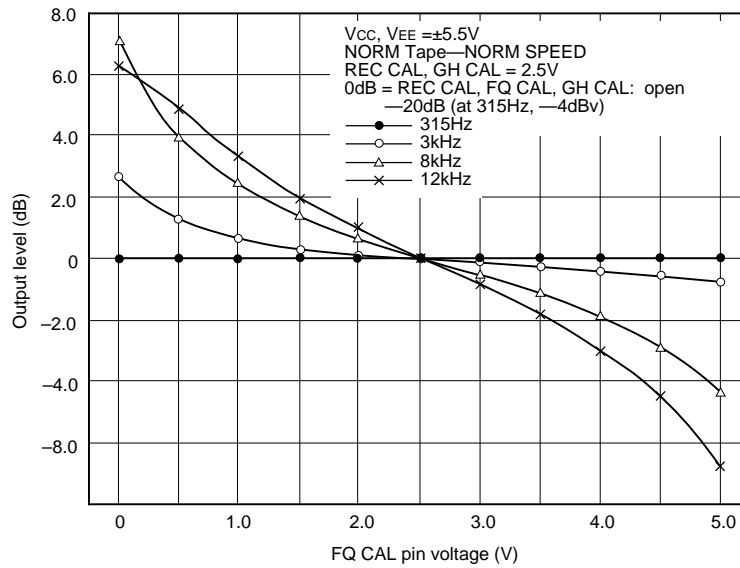

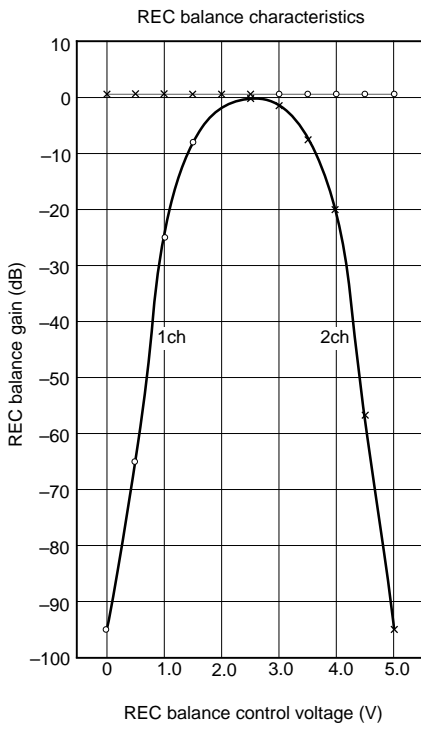
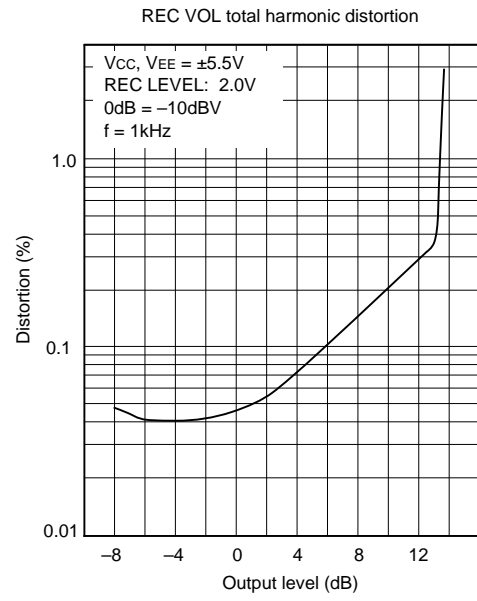
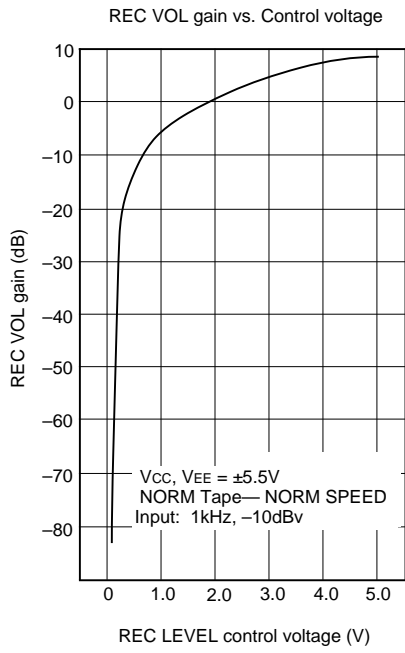

NR B type encoding characteristics

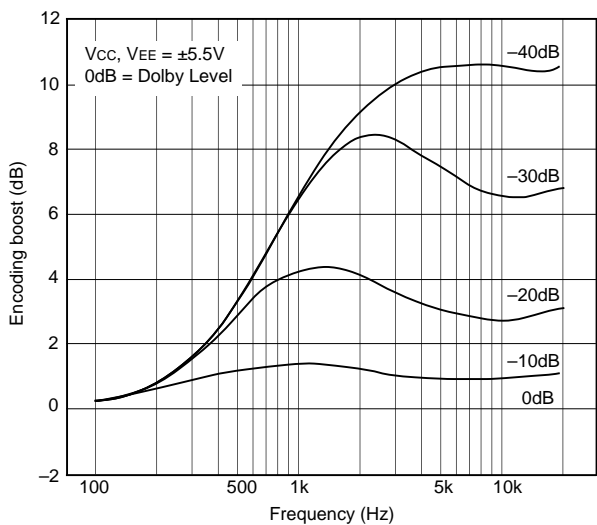

NR C type encoding characteristics

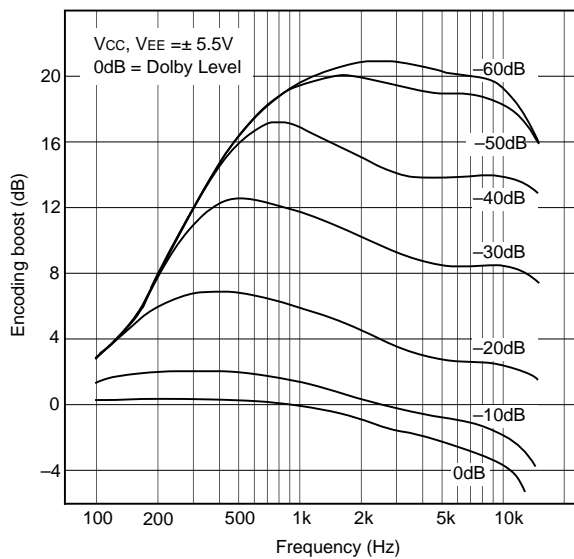

NR off total harmonic distortion

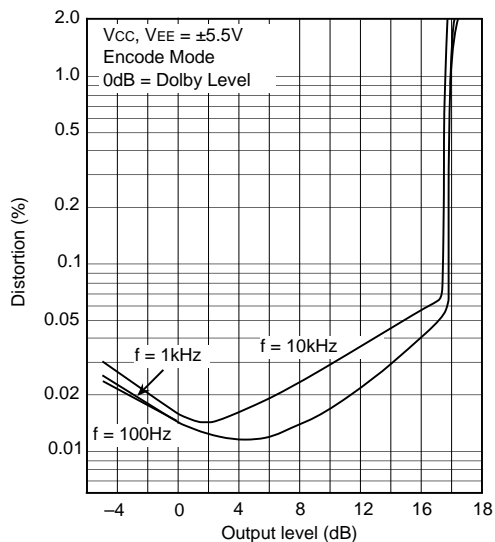

NR B type total harmonic distortion

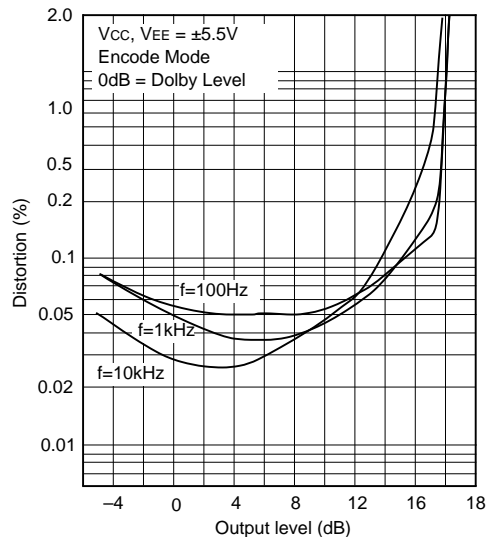

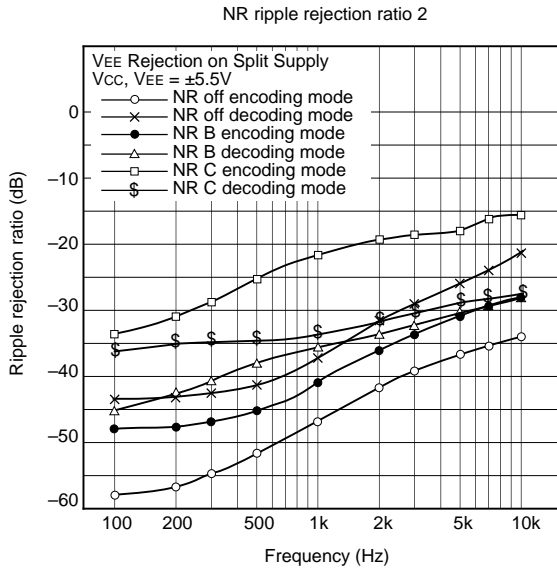
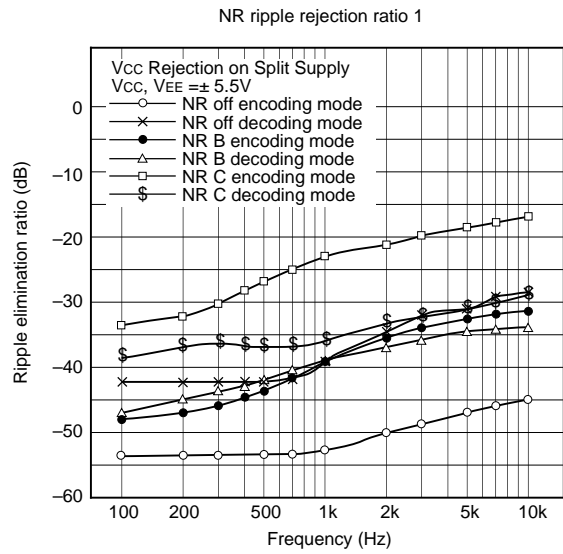
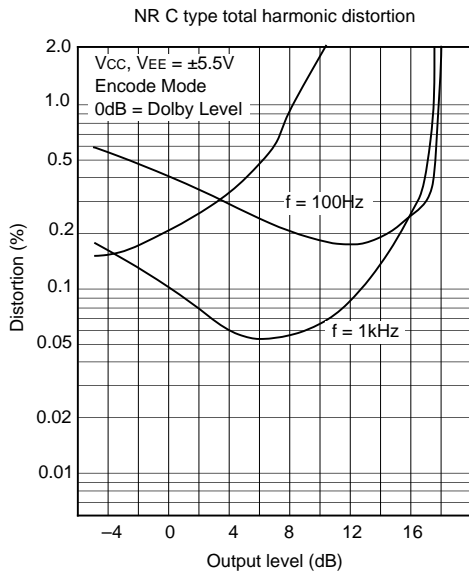

Package Outline Unit : mm

64PIN QFP(PLASTIC)

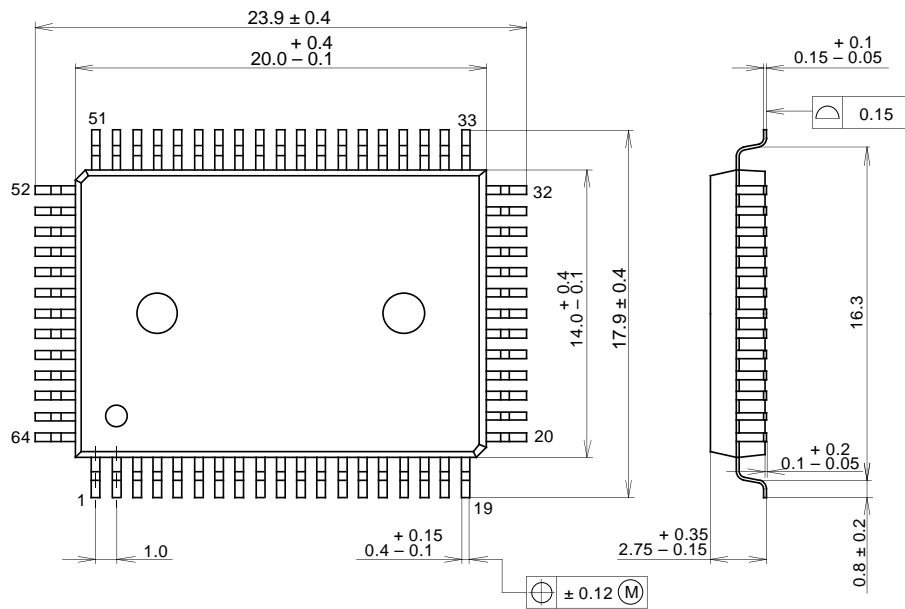

PACKAGE STRUCTURE

SONY CODE	QFP-64P-L01
EIAJ CODE	*QFP064-P-1420
JEDEC CODE	_____

PACKAGE MATERIAL	EPOXY RESIN
LEAD TREATMENT	SOLDER/PALLADIUM PLATING
LEAD MATERIAL	COPPER /42 ALLOY
PACKAGE WEIGHT	1.5g



LittleDiode supplies new, hard to find or obsolete electronic components and semiconductors all over the world.

With over two million different components listed you are sure to find the part you need.

Feel free to visit us today at our online store:

LittleDiode.com

Looking forward to providing you with the best possible service.