

**UHF-Band RF Modulator for VCR**

**Description**

The CXA1733M is a UHF-band RF modulator which converts the frequency of audio and video signals. Some circuits which comprise this IC are a UHF oscillator video clamp, white clip, video modulator, audio FM modulator, test pattern signal generator, and an intercarrier SW.

**Features**

- Low voltage of 5V
- Wide bandwidth 470 to 750MHz
- UHF oscillator greatly reduces external parts
- Sharp white clip circuit
- Built-in voltage regulator can accept large fluctuation of supply voltage
- Video input of 0.5Vp-p for general purpose use
- Mixer simplifies RF unit design
- Picture/sound ratio is adjustable with external parts
- Test pattern signal generator
- Inter carrier switch

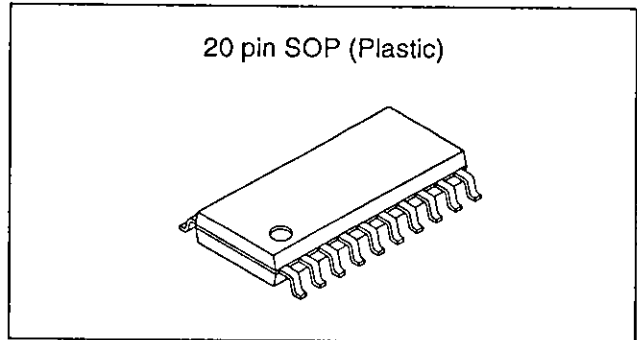

**Structure**

Bipolar silicon monolithic IC

**Applications**

PAL system VCR

**Absolute Maximum Ratings (Ta=25 °C)**

• Supply voltage	Vcc	7	V
• Operating temperature	Topr	-20 to +75	°C
• Storage temperature	Tstg	-55 to +150	°C
• Allowable power dissipation	Pd	350	mW

**Recommended Supply Voltage Range**

Supply voltage	Vcc	5.0±0.5	V
----------------	-----	---------	---

**Block Diagram and Pin Configuration**

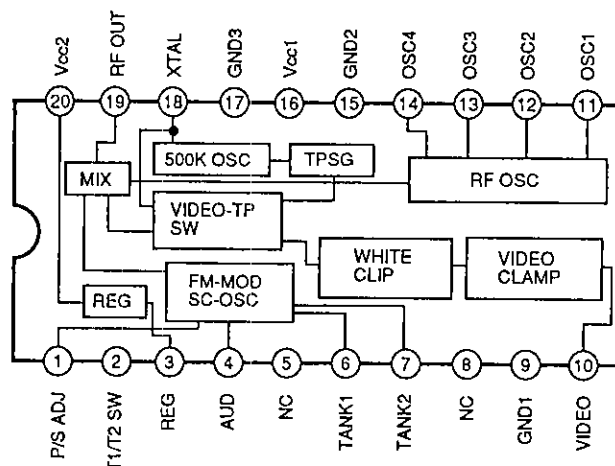

Sony reserves the right to change products and specifications without prior notice. This information does not convey any license by any implication or otherwise under any patents or other right. Application circuits shown, if any, are typical examples illustrating the operation of the devices. Sony cannot assume responsibility for any problems arising out of the use of these circuits.

Pin Description and Equivalent Circuit

Pin No.	Symbol	Pin voltage (V) Typical	Equivalent circuit	Description
1	P/S ADJ	1.8		<p>P/S adjustment (Adding a capacitor between Pin 1 and GND increases P/S ratio.) Video modulation depth adjustment (Adding a resistor between Pin 1 and GND increases the modulation depth; adding a resistor between Pin 1 and 3 decreases the modulation depth.)</p>
2	T1/T2 SW	2.4		<p>T1/T2 SW. T1 for GND. T2 for OPEN.</p>
3	REG OUT	4.1		<p>Regulator output.</p>
4	AUDIO IN	0		<p>Audio input.</p>
5	NC			
6	TANK1	3.1		<p>5.5MHz audio tank coil connection.</p>

Pin No.	Symbol	Pin voltage (V) Typical	Equivalent circuit	Description
7	TANK2	2.9		6.0MHz audio tank coil connection.
8	NC			
9	GND1			GND for audio.
10	VIDEO IN	2.6		Video input.
11 12 13 14	OSC1 OSC2 OSC3 OSC4	2.5 1.7 1.7 2.5		Oscillator pin.
15	GND2			GND for oscillator.
16	Vcc1			Power supply for oscillator.
17	GND3			GND for RF.

Pin No.	Symbol	Pin voltage (V) Typical	Equivalent circuit	Description
18	TPSG SW	1.2		Crystal is connected to this pin. TPSG is OFF for GND.
19	RF OUT	4.1		RF output.
20	Vcc2			Power supply for RF/audio.

**Electrical Characteristics 1**

Refer to Electrical Characteristics Test Circuit (Ta=25°C, Vcc=5V, fP=591.25MHz)

Item	Symbol	Conditions	Min.	Typ.	Max.	Unit	
Supply current	Icc	V1(VIDEO IN) and V2(AUDIO IN) at no signal	23	32	40	mA	
Video output level	Vo	*1	78.7	81.2	83.7	dB μV	
Video modulation depth	mp	V1=0.5Vp-p, FLAT FIELD signal input	72	78.5	86	%	
Max. video modulation depth (During limiter operation)	mp (Max.)	V1=1.0Vp-p, FLAT FIELD signal input	92	95.5	99	%	
Chroma beat	Vcb	V1=4.43MHz, 0.5Vp-p sine wave input *5	68	78	—	dB	
Sync crush level	Δ Sync	V1=0.5Vp-p, FLAT FIELD signal input Δ Sync = $(1 - \frac{S}{W} \cdot \frac{10}{4}) \times 100$	—	2	5	%	
Differential gain	DG	STAIR STEP signal input V1=0.5Vp-p *2	0	1.6	5	%	
Differential phase	DP	STAIR STEP signal input V1=0.5Vp-p *2	−5	0	5	deg	
Video 2nd-harmonic wave ratio	VvH	V1=0.5Vp-p, 1MHz sine wave input*3	48	52.5	—	dB	
PS ratio	Vps	V1=no input, fs=5.5MHz	11.5	14	16.5	dB	
Audio FM modulation sensitivity	β S1 (T1)	V2=100mVp-p, 1kHz sine wave input fs frequency change/ 0.1V *6	fs=5.5MHz	0.37	0.42	0.475	kHz/mV
	β S2 (T2)		fs=6.0MHz	0.34	0.4	0.47	
Audio distortion	THD	V2=1kHz sine wave input *4	0	0.4	1	%	
Audio S/N ratio	ASN	V2=1kHz sine wave input 0dB at fs=5.5MHz with 60kHz deviation V1=STAIR STEP signal input (rms measurement)	45	54	—	dB	
Max. audio FM modulation depth	ms (Max.)	V2=1Vp-p, 1kHz sine wave input (T1) fs frequency change (kHz)/ 100 kHz ×100	380	415	—	%	
Audio 2nd-harmonic wave ratio	Vs2	Difference between video carrier (V1=no input) and 2nd-harmonic wave, at PS ratio of 14dB conversion	52	57	—	dB	
TPSG synchronization period	TMtp	S2 OFF	62	64	66	μsec	
TP video modulation depth	Mtp	S2 OFF	70	80	90	%	
Supply current when TPSG is ON	Icc Ton	S2 OFF	24	34	43	mA	

**Classification of Audio Modulation Sensitivity (T1, fs=5.5MHz)**

Marking	Audio modulation sensitivity	Unit
CXA1733M-1	0.4 to 0.445	kHz/mV
CXA1733M-2	0.37 to 0.41	kHz/mV
CXA1733M-3	0.435 to 0.475	kHz/mV

**Electrical Characteristics 2**

1. Video S/N	50dB (min.), 58dB (typ.)
2. Video amplitude frequency characteristics (at 1MHz reference)	Within $\pm 1$ dB at 0.5 to 5MHz
3. APL variation (Normalized to APL 50%)	Within $\pm 2\%$ at 10 to 90%
4. Pin 4 input impedance	1M $\Omega$ and above
5. Pin 10 input impedance	1M $\Omega$ and above

\*1. Spectrum analyzer with 50 $\Omega$  input impedance should be used to test video output level. Measured value Vo (dBm) is used to calculate output according to following relationship:

$$\text{Output (dB } \mu\text{)} = \text{Vo (dBm)} + 107 \quad 50\Omega \text{ terminal direct reading value}$$

- \*2. Measured after demodulating by standard demodulator.
- \*3.  $f_c + 2\text{MHz}$  component of V1 carrier ( $f_c$ ) level.
- \*4. Adjust the V2 level to obtain an FM deviation of  $\pm 30\text{kHz}$  and measure the harmonic distortion after demodulating Vo with a standard demodulator.
- \*5. Value determined by measuring ratio (dB) of chroma beat to video carrier level when V1=no signal by spectrum analyzer.
- \*6. R1 (12k $\Omega$ ) of the Electrical Characteristics Test Circuit is added for obtaining a better match between the audio modulation sensitivity classifications and the actual pre-emphasis.

**Input Waveform**

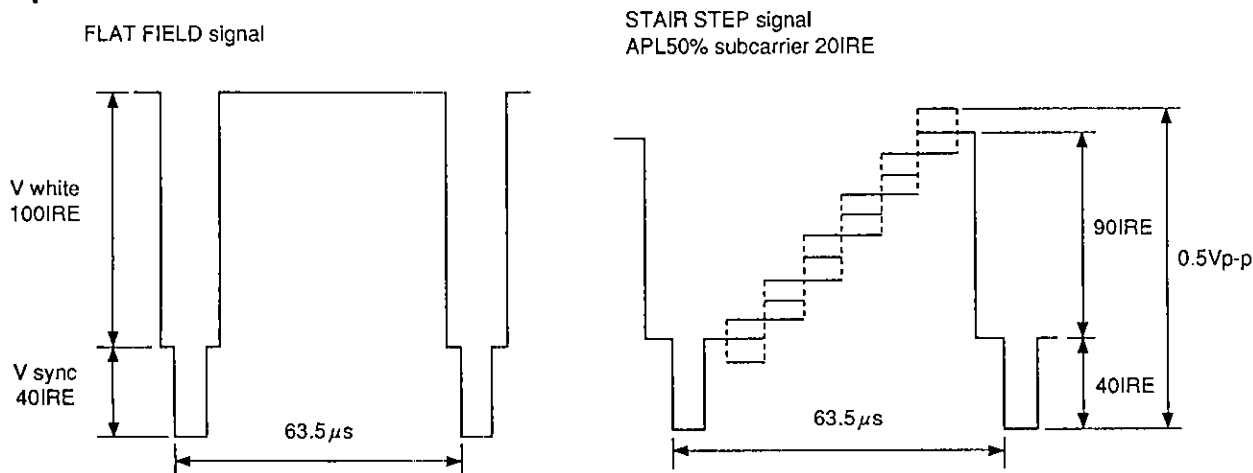

**TPSG Waveform**

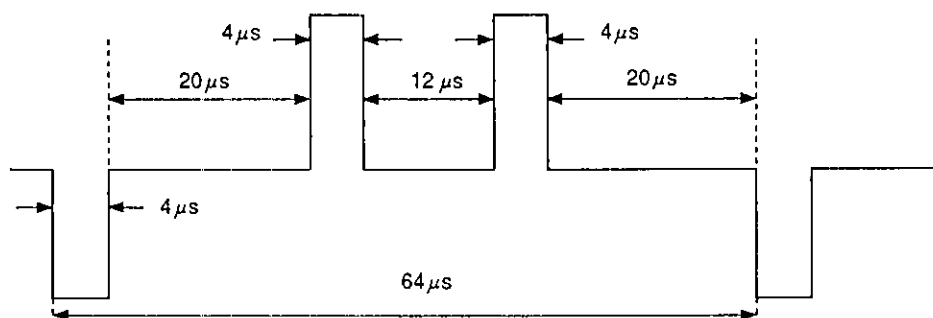



Application Circuit 1

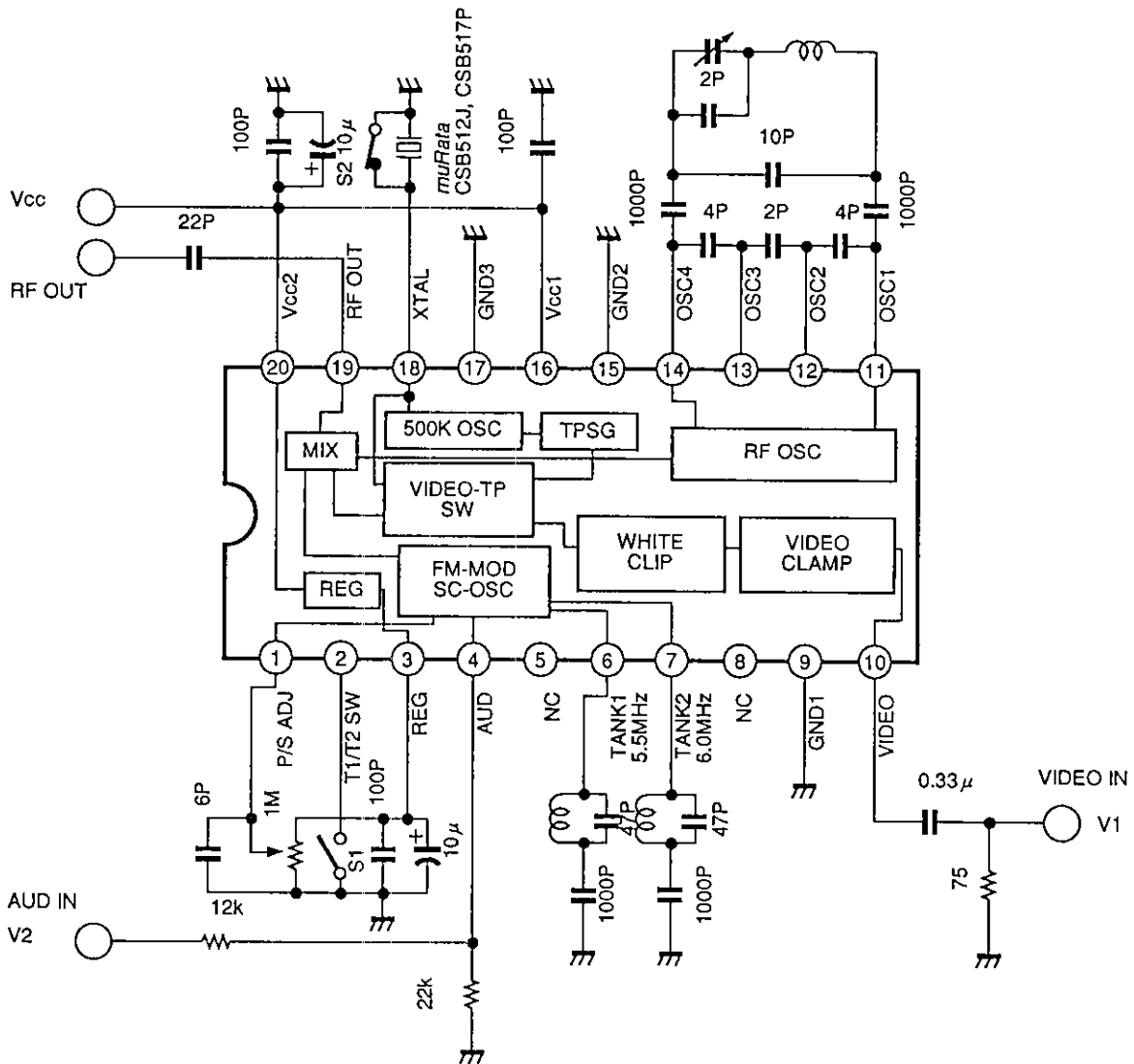

Application circuits shown are typical examples illustrating the operation of the devices. Sony cannot assume responsibility for any problems arising out of the use of these circuits or for any infringement of third party patent and other right due to same.

Application Circuit 2

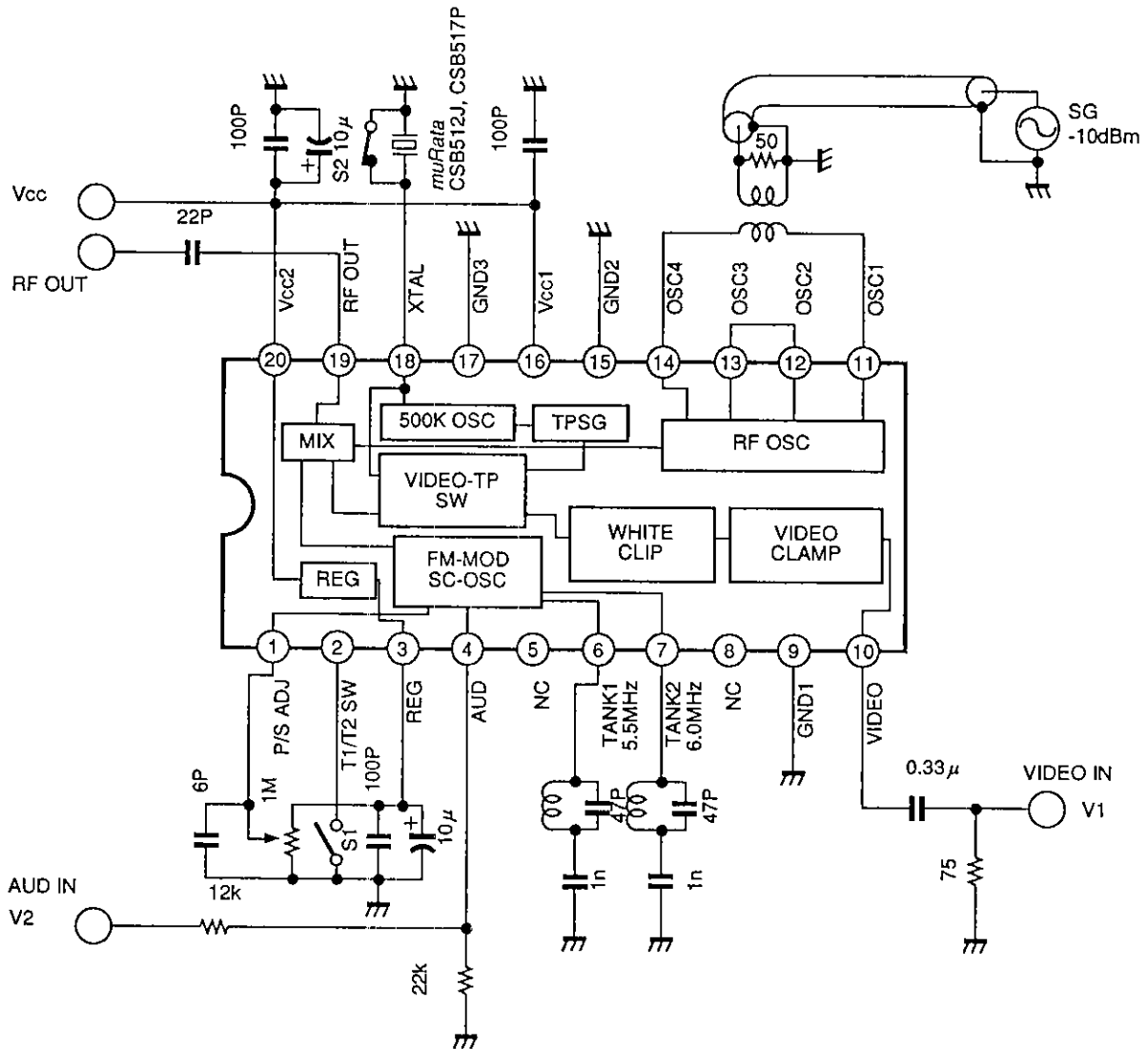

Application circuits shown are typical examples illustrating the operation of the devices. Sony cannot assume responsibility for any problems arising out of the use of these circuits or for any infringement of third party patent and other right due to same.

Example of Representative Characteristics

( $f_p=591.25\text{MHz}$ ,  $T_a=25^\circ\text{C}$ )

Supply voltage vs. Video output level

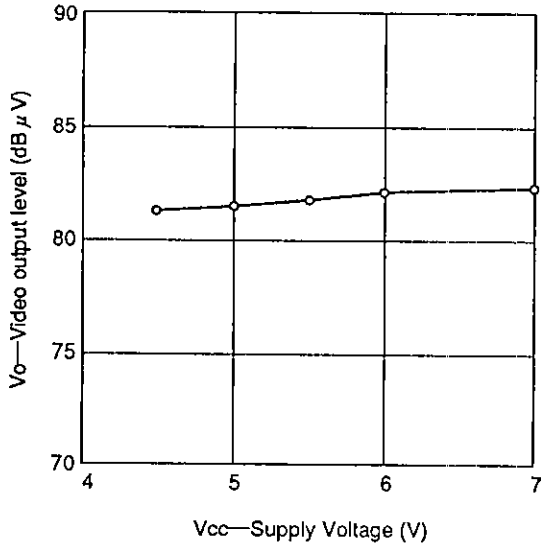

Supply voltage vs. Video modulation depth

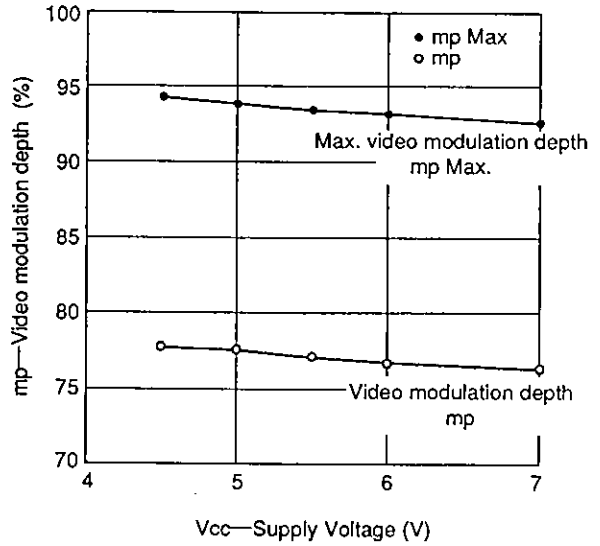

Supply voltage vs. PS ratio

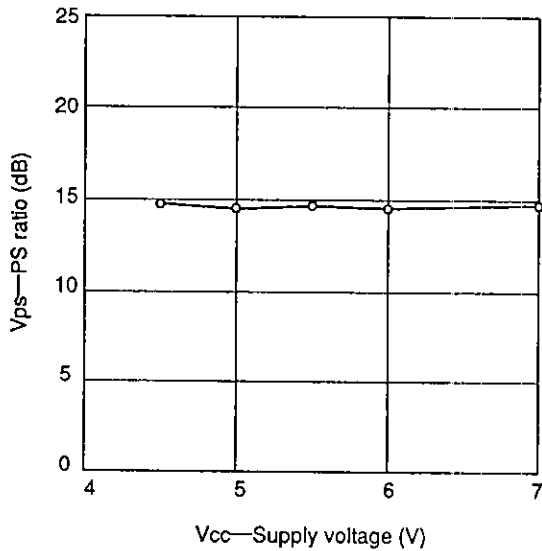

Supply voltage vs. Audio FM modulation sensitivity

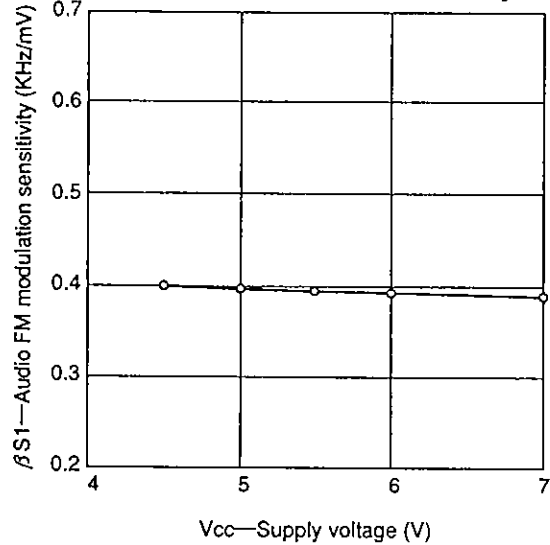

Ambient temperature vs. Video output level

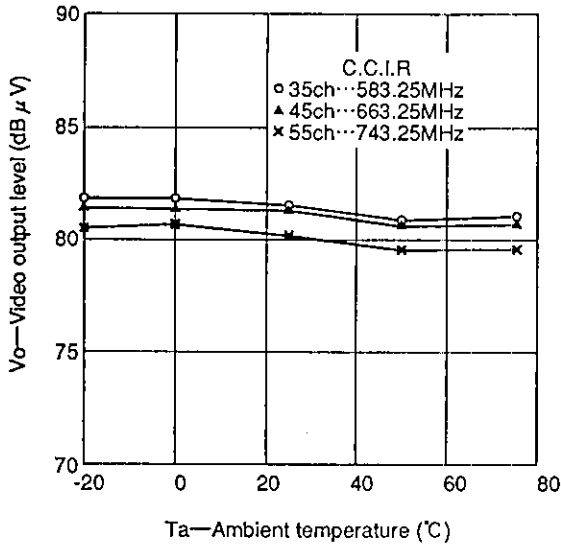

Ambient temperature vs. Video modulation depth

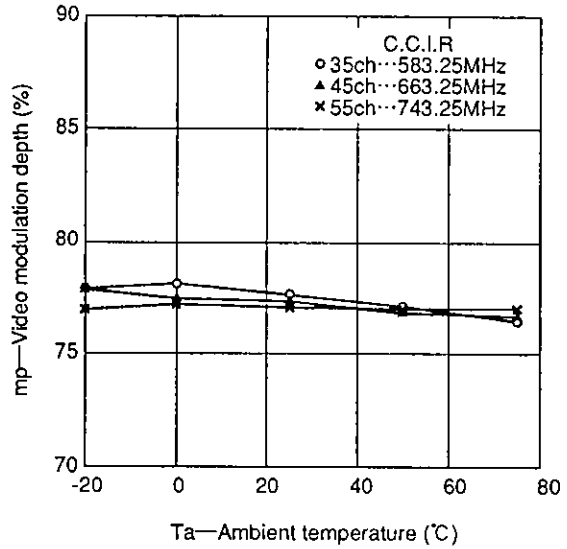

Ambient temperature vs. Max. video modulation depth

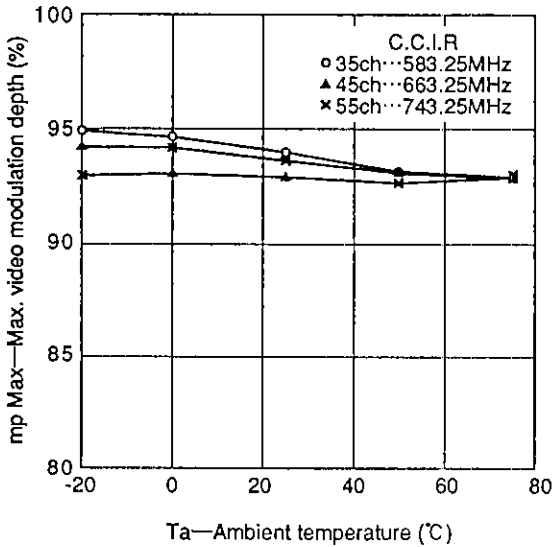

Ambient temperature vs. PS ratio

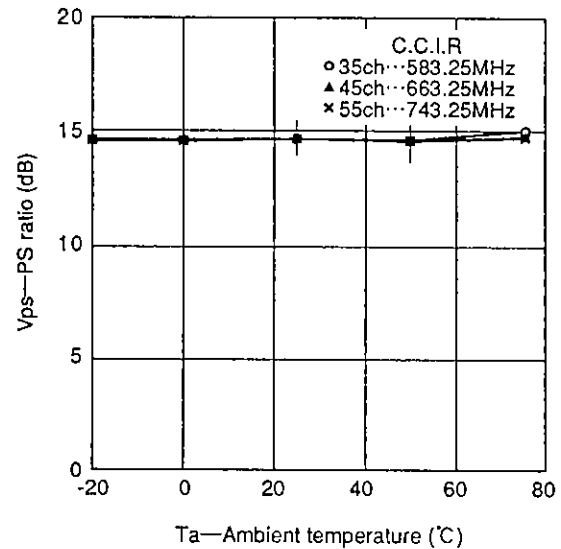

Ambient temperature vs. Audio 2nd-harmonic wave ratio

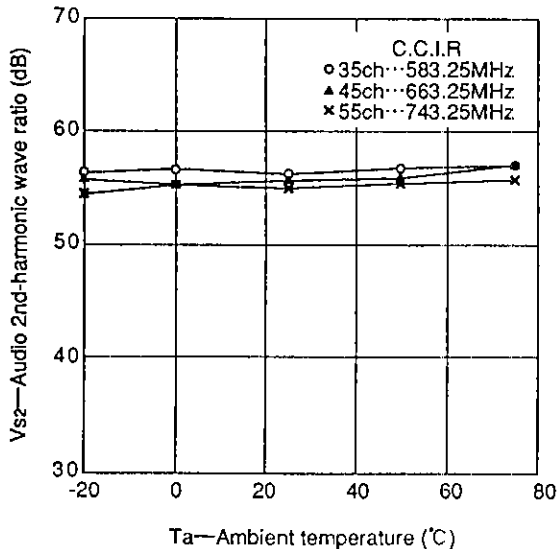

Ambient temperature vs. Video 2nd-harmonic wave ratio

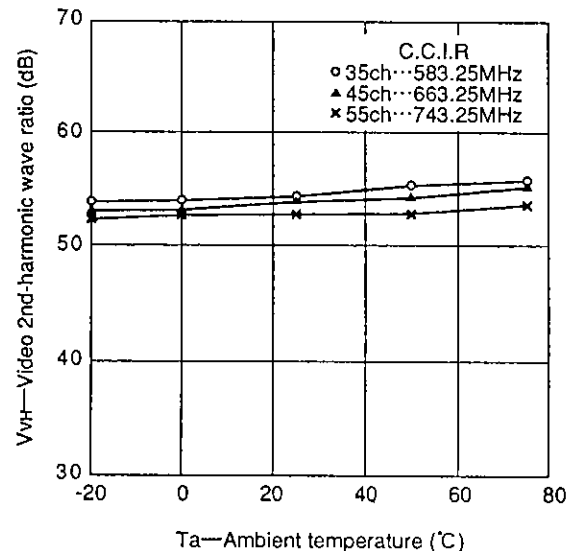

Ambient temperature vs. Chroma beat

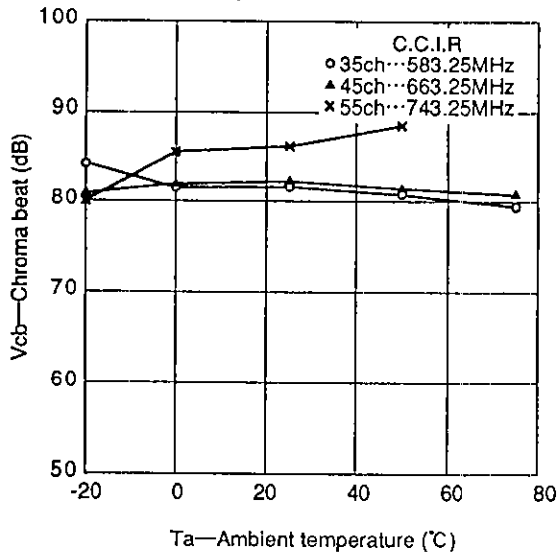

Ambient temperature vs. Differential gain

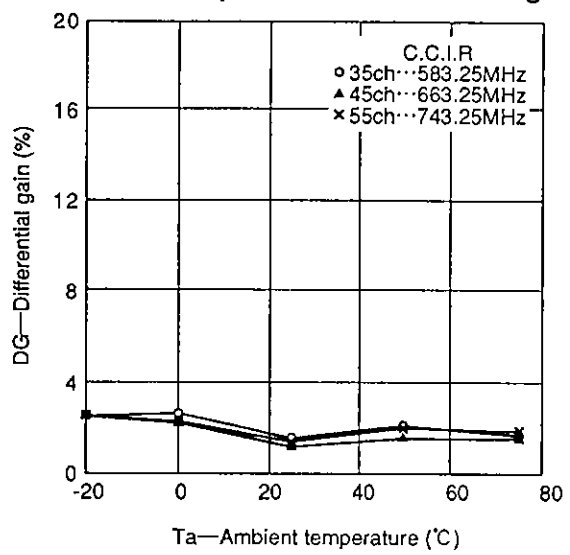

Ambient temperature vs. Differential phase

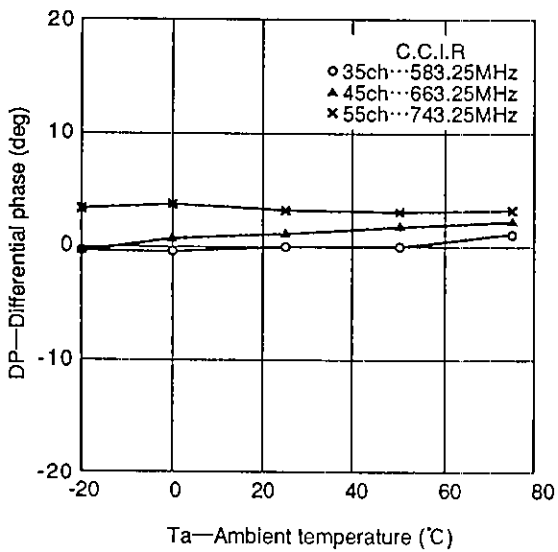

Ambient temperature vs. Audio distortion

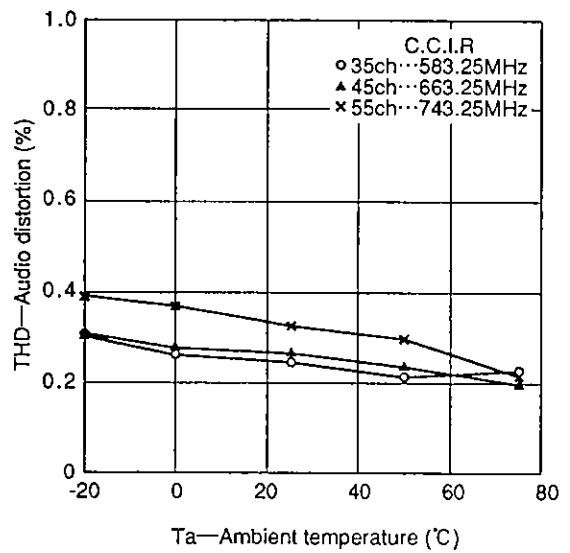

Ambient temperature vs. Audio S/N ratio

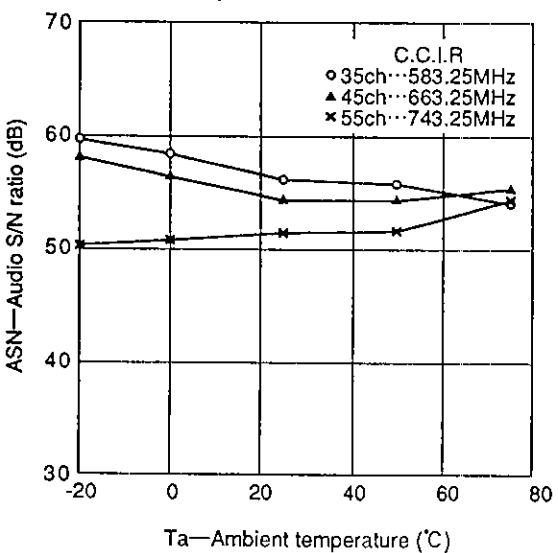

Ambient temperature vs. Sync crush level

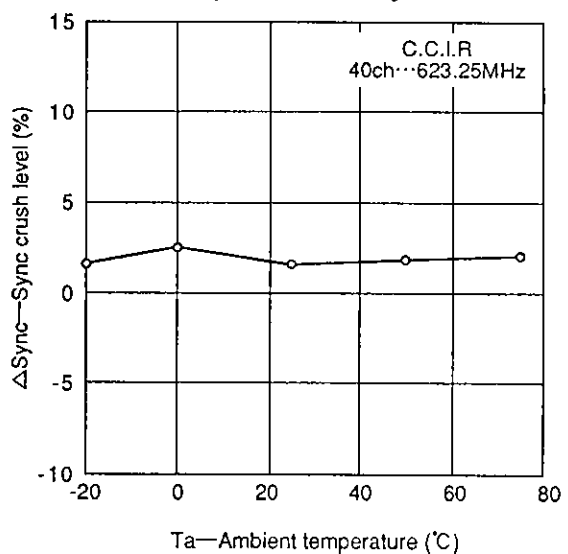

**Ambient temperature vs.  
Audio FM modulation sensitivity**

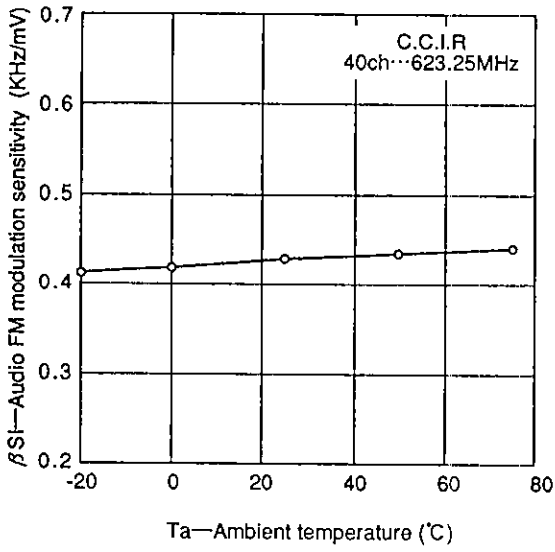

**Ambient temperature vs.  
Max. audio FM modulation depth**

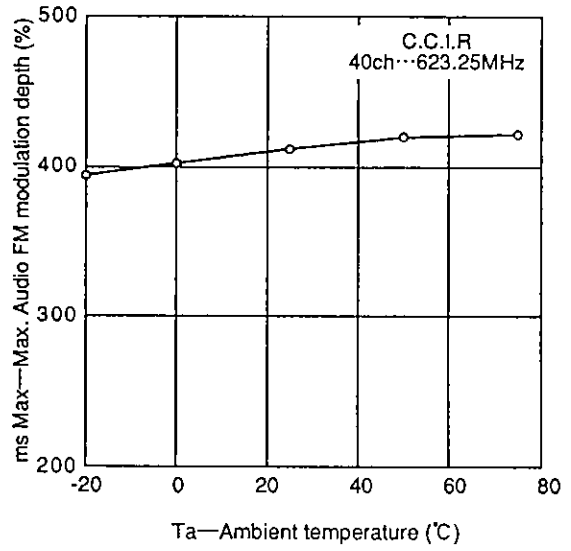

Video carrier frequency vs. Video output level

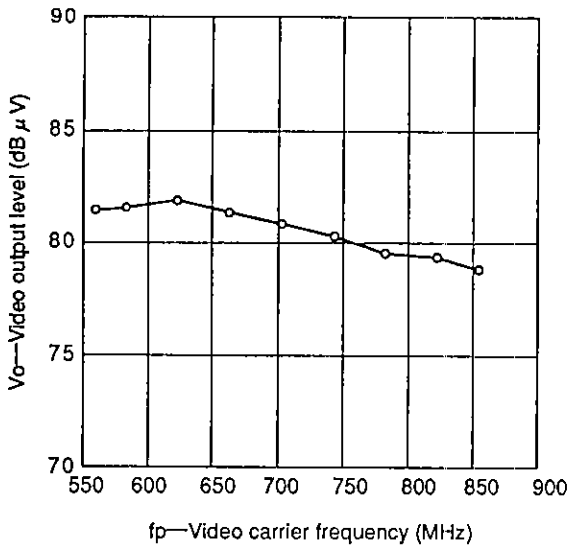

Video carrier frequency vs. Video modulation depth

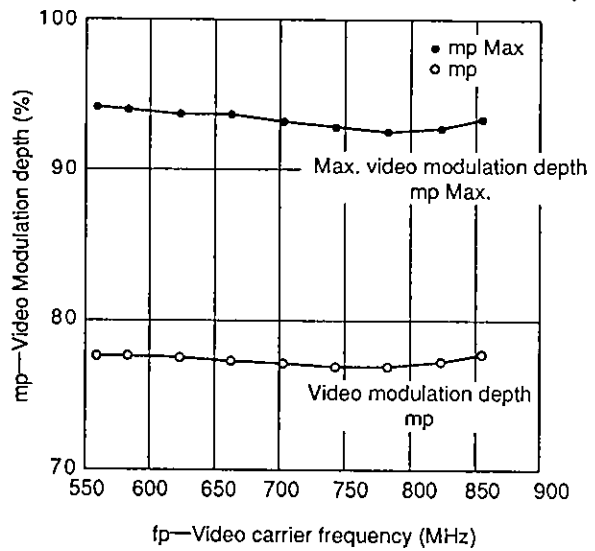

Video carrier frequency vs. PS ratio

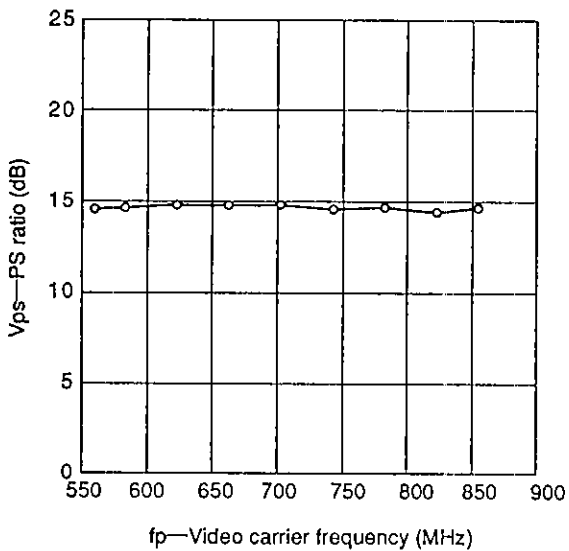

Video carrier frequency vs. Audio 2nd-harmonic wave ratio

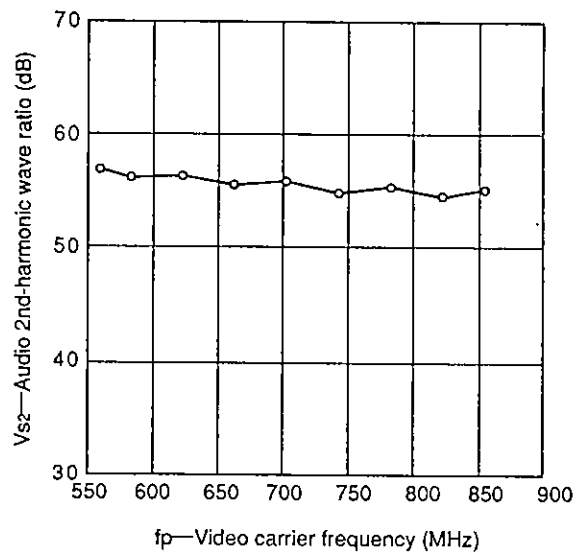

Video carrier frequency vs. Video 2nd-harmonic wave ratio

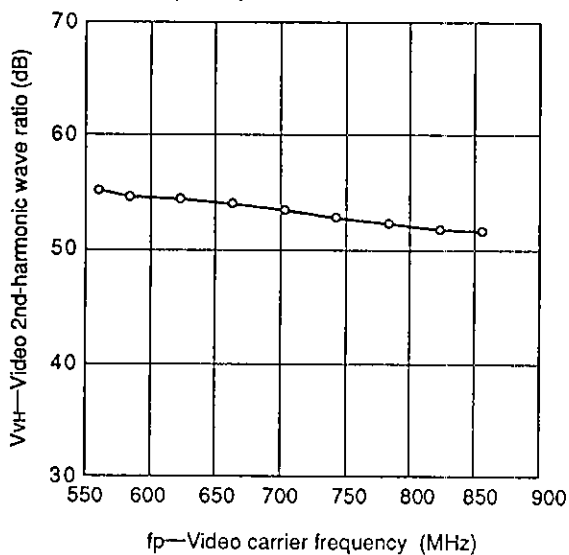

Video carrier frequency vs. Chroma beat

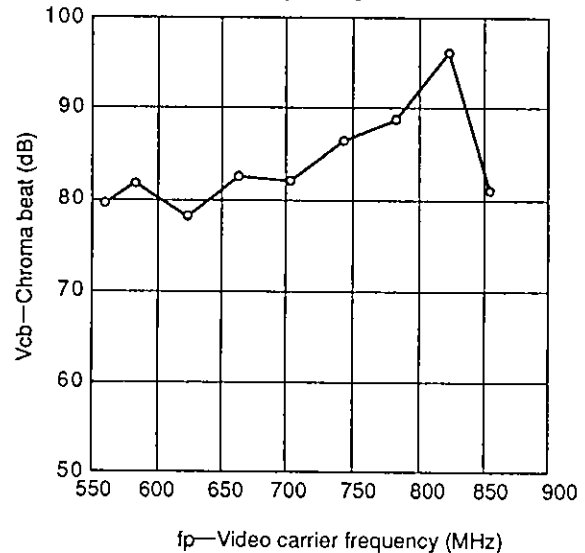

Video carrier frequency vs. Audio distortion

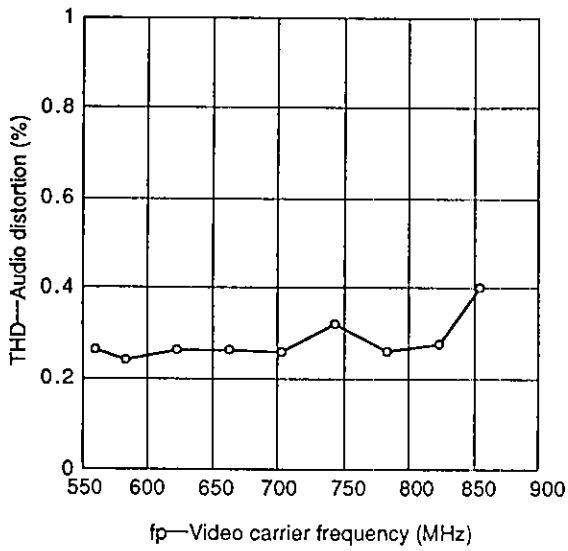

Video carrier frequency vs. Audio S/N ratio

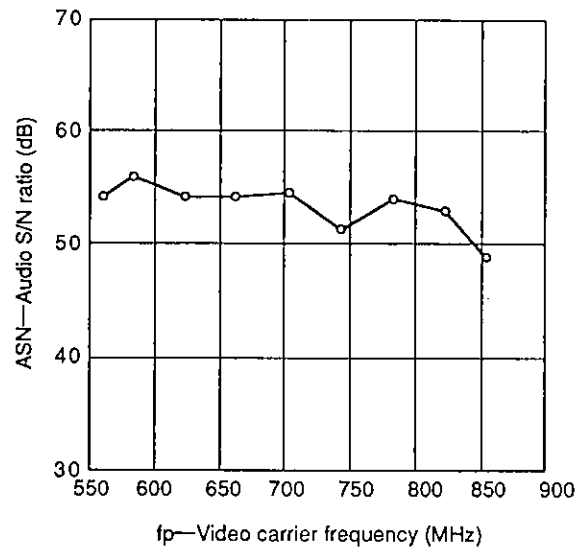

Video carrier frequency vs. Differential gain

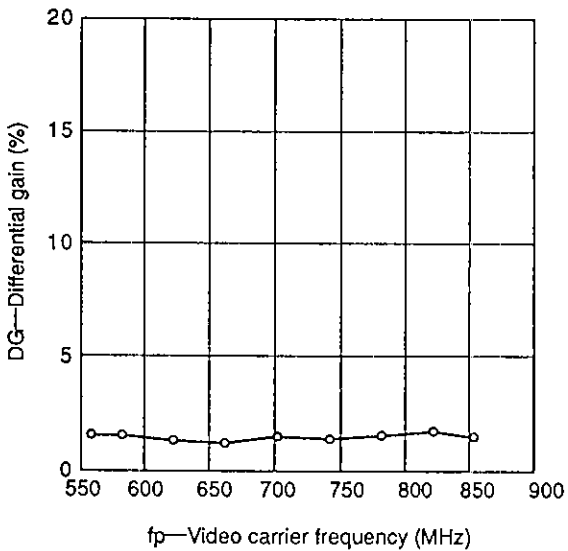

Video carrier frequency vs. Differential phase

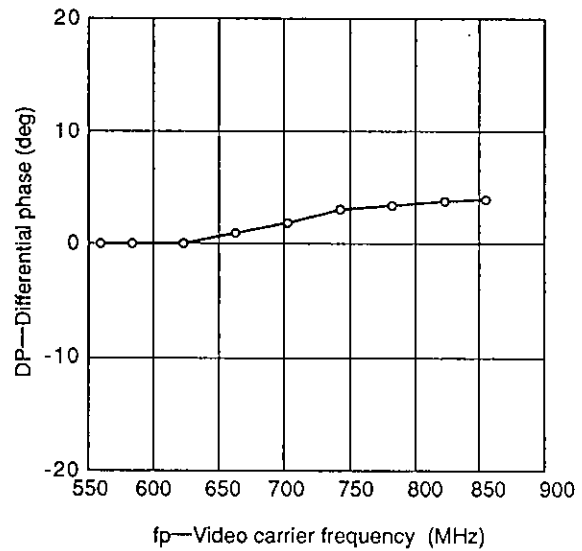

Package Outline

Unit: mm

20PIN SOP (PLASTIC) 300MIL

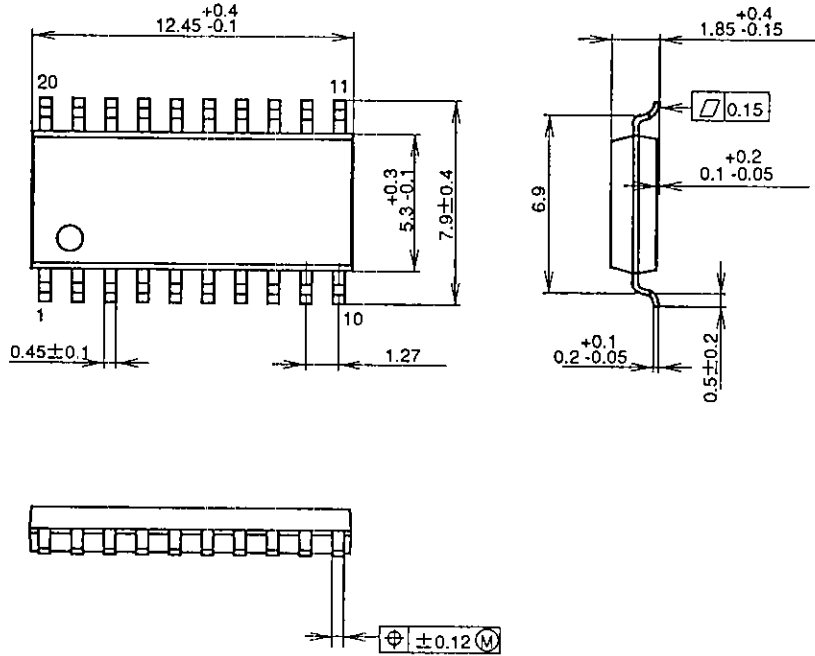

SONY CODE	SOP-20P-L01
EIAJ CODE	*SOP020-P-0300-A
JEDEC CODE	—

PACKAGE STRUCTURE

PACKAGE MATERIAL	EPOXY RESIN
LEAD TREATMENT	SOLDER PLATING
LEAD MATERIAL	COPPER ALLOY
PACKAGE WEIGHT	0.3g

This datasheet has been downloaded from:

[www.DatasheetCatalog.com](http://www.DatasheetCatalog.com)

Datasheets for electronic components.



LittleDiode supplies new, hard to find or obsolete electronic components and semiconductors all over the world.

With over two million different components listed you are sure to find the part you need.

Feel free to visit us today at our online store:

[LittleDiode.com](http://LittleDiode.com)

Looking forward to providing you with the best possible service.