

8 mm VCR AFM Signal Processor

Description

The CXA1488R is an IC designed for recording and playback FM audio signal processing for an 8 mm VCR. In combination with a CXA1536Q device it offers an effective implementation of an AFM audio stereo system.

Features

- Built-in filter (1.5 MHz bandpass filter)
- Requires no adjustment of FM modulator central frequency.
- Low current consumption (standby 24 mA, recording 27 mA, playback 1 (band-pass filter on) 31 mA, playback 2 (band-pass filter off) 27 mA)
- PAL/NTSC selectable
- Stereo compatible
- Very few external part

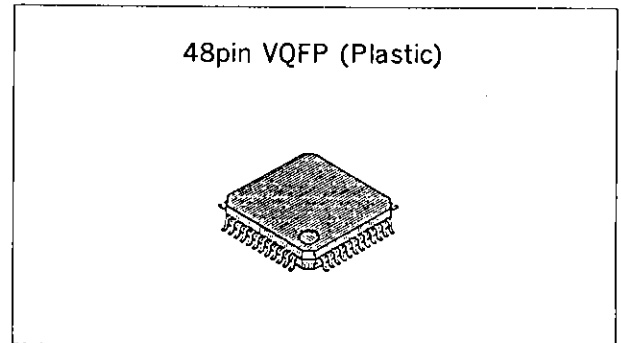

Application
8 mm VCR

Structure

Bipolar silicon monolithic IC

Block Diagram

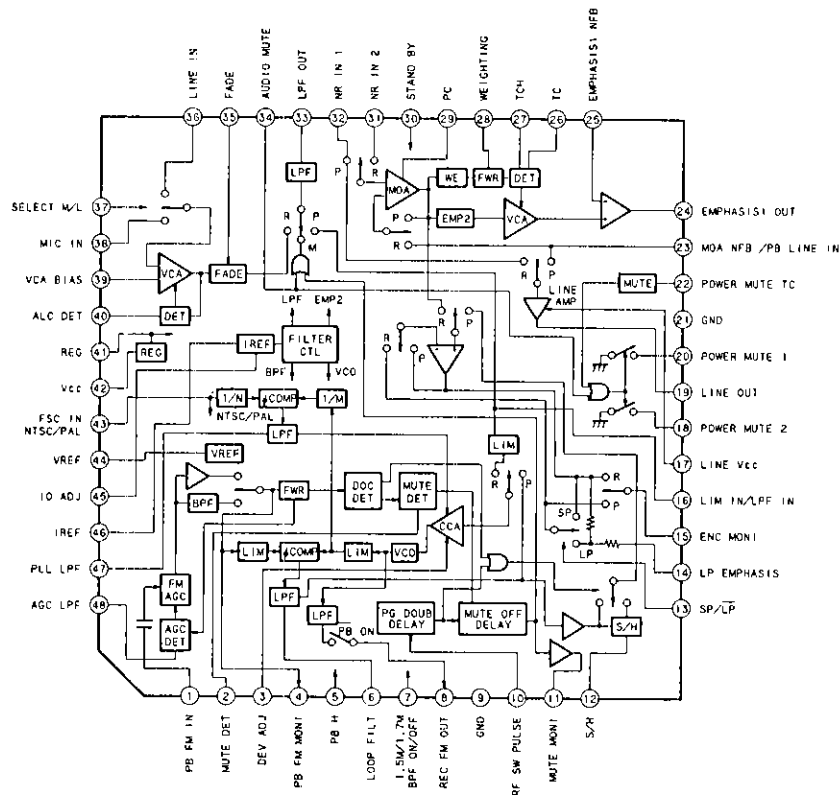

Absolute Maximum Ratings (Ta = 25°C)

• Supply voltage	V_{CC}	7	V
• Operating temperature	T_{opr}	-20 to +75	°C
• Storage temperature	T_{stg}	-40 to +150	°C
• Allowable power dissipation	P_D	600	mW

Operating Conditions

• Supply voltage	4.75	V
• Supply voltage range	4.5 to 5.5	V



Pin Description

0 dBs = 2.191 Vp-p

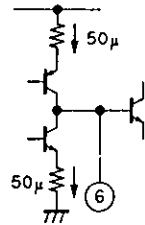
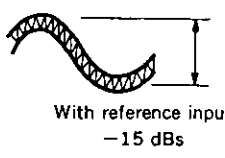
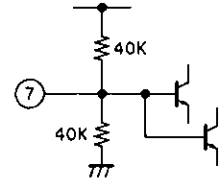
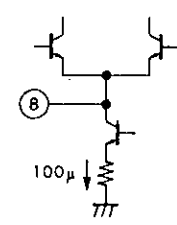
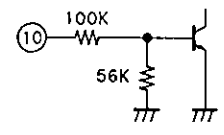
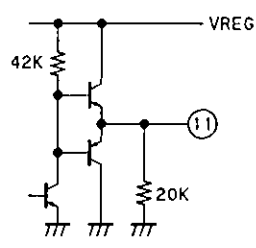
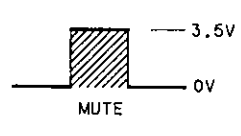
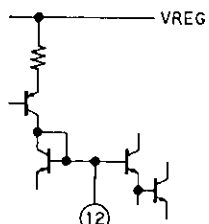
No.	Symbol	DC voltage	AC voltage	Equivalent circuit	Remarks
1	PB FM IN	—	—		Reference input level is 30 mVp-p with AFM
2	MUTE DET	—	—		
3	DEV ADJ	—	—		Input voltage 1.85 V to V _{CC}
4	PB FM MONI	2.1 V	250 mVp-p		Load resistor connected in monitor mode
5	PB H	0 V	—		High: playback Low/open: record

No.	Symbol	DC voltage	AC voltage	Equivalent circuit	Remarks
6	LOOP FILT	2.1 V	-15 dBs		 With reference input -15 dBs
7	BPF ON/OFF 1.5M/1.7M	—	—		High: 1.5 MHz band-pass filter on Open: 1.5 MHz band-pass filter off Low: 1.7 MHz band-pass filter off
8	REC FM OUT	2.1 V	340 mVp-p		In playback mode Standard DC: 1.4 V Standard AC: 0 V
9	GND	—	—	—	
10	RF SW P. IN	—	—		
11	MUTE MONI	—	—		 MUTE
12	S/H	2.1 V	-15 dBs		With reference input

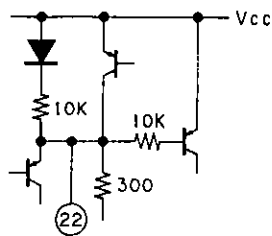
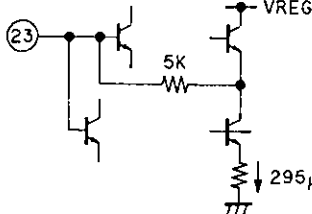
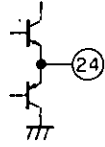
No.	Symbol	DC voltage	AC voltage	Equivalent circuit	Remarks
13	SP/LP	—	—		High: SP Low/open: LP
14	LP EMPHISIS	2.1 V	-15 dBs		With reference input
15	ENC MONI	2.1 V	-15 dBs		With reference input (with no playback signal: 0 V)
16	LIM IN	2.1 V	-15 dBs		With reference input
17	LINE V _{CC}	—	—	—	
18	POWER MUTE2	—	—		
19	LINE OUT	2.1 V	-7 dBs		With reference input
20	POWER MUTE1	—	—		

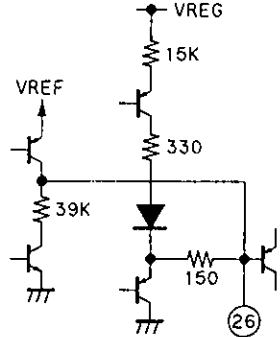
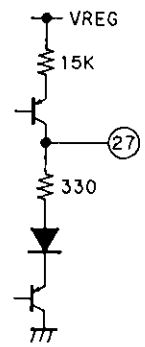
No.	Symbol	DC voltage	AC voltage	Equivalent circuit	Remarks
21	GND	—	—		
22	POWER MUTE TC	—	—		
23	MOA NFB	2.1 V	-15 dBs		With reference input
24	EMP1 OUT	2.1 V	-15 dBs		With reference input
25	EMP1 NFB	2.1 V	-27.6 dBs		With reference input
26	TC	2 V approx.	—		With reference input
27	TCH	2.6 V approx.	—		With reference input

No.	Symbol	DC voltage	AC voltage	Equivalent circuit	Remarks
28	WEIGHTING	2.1 V	—		
29	PC	2.8 V	—		
30	STAND BY	2.1 V	—		High: standby off Low/open: standby on
31	NR IN2	2.1 V	-15 dBs		With reference input
32	NR IN1	2.1 V	-15 dBs		With reference input
33	LPF OUT	2.1 V	-15 dBs		With reference input
34	AUDIO MUTE	2.1 V	—		High/open: mute on Low: mute off

No.	Symbol	DC voltage	AC voltage	Equivalent circuit	Remarks
35	FADE	—	—		Input voltage 1.85 V to V _{CC}
36	LINE IN	2.1 V	—		Reference input level -20.5 dBs
37	SELECT	—	—		High: MIC Low/open: LINE
38	MIC IN	2.1 V	—		Reference input level -38.0 dBs
39	ALC BIAS	2.1 V	—		
40	ALC DET	—	—		I _R : MIC: 24.8 μA LINE: 4.6 μA

No.	Symbol	DC voltage	AC voltage	Equivalent circuit	Remarks
41	REG	4.2 V	—		
42	V_{CC}	—	—	—	
43	FSC IN NTSC/PAL	—	—		<p>FSC = 100 to 200 mVp-p High - NTSC Low/open: PAL</p>
44	VREF	2.1 V	—		
45	I_0 ADJ	—	—		<p>Input voltage 1.85 V to V_{CC}</p>
46	I REF	2.2 V	—		<p>When 3.3 V is applied to Pin 45</p>

No.	Symbol	DC voltage	AC voltage	Equivalent circuit	Remarks
47	PLL LPF	2.1 V	—		
48	AGC LPF	2.1 V	—		

Electrical Characteristics (Ta = 25°C, V_{CC} = 4.75 V)0 dBs = 2.191 V_{p-p}

No.	Item	Symbol	Conditions		Min.	Typ.	Max.	Unit
			Input	Test point				
1	Current consumption standby	I _{CCST}		I _{CC}	19.2	24.0	28.8	mA
2	Current consumption recording	I _{CC R}		↓	21.6	27.0	32.4	mA
3	Current consumption playback 1 (band-pass filter on)	I _{CC P1}		↓	24.8	31.0	37.2	mA
4	Current consumption playback 2 (band-pass filter off)	I _{CC P2}		↓	21.6	27.0	32.4	mA
5	REG output	V _{REG}		TP9	4.05	4.20	4.35	V
6	Reference voltage	V _{REF}		TP10	2.02	2.10	2.18	V

REC MODE <ALC, LPF>

7	Input switch crosstalk 1	CT1	10kHz, -5dBs	TP8		-78	-70	dB
8	Input switch crosstalk 2	CT2	10kHz, -5dBs	↓		-78	-70	dB
9	ALC output level 1	V _{oa 1}	400Hz, -38dBs (MIC input)	↓	-16.0	-15.0	-14.0	dBs
10	ALC output level 2	V _{oa 2}	400Hz, -21dBs (LINE input)	↓	-16.0	-15.0	-14.0	dBs
11	ALC output level 3	V _{oa 3}	400Hz, -25dBs (MIC input)	↓	-10.5	-9.0	-7.5	dBs
12	ALC effect	ALC	400Hz, -28dBs → -2dBs	↓		0	3.0	dB
13	FADE attenuation	ATT	400Hz, -38dBs IN4=4.5V	↓		-85	-80	dB

<NR>

14	Output level 1	V _{oe 1}	400Hz, -15dBs	TP4	-16.0	-15.0	-14.0	dBs
15	Output level 2	V _{oe 2}	400Hz, -35dBs	↓	-26.5	-25.0	-23.5	dBs
16	Output level 3	V _{oe 3}	400Hz, -55dBs	↓	-37.0	-35.0	-33.0	dBs
17	Output level 4	V _{oe 4}	7kHz, -15dBs	↓	-12.4	-10.9	-9.4	dBs
18	Output level 5	V _{oe 5}	7kHz, -35dBs	↓	-22.4	-20.9	-19.4	dBs
19	Output level 6	V _{oe 6}	7kHz, -55dBs	↓	-32.9	-30.9	-28.9	dBs
20	Distortion factor	THDE	400Hz, -15dBs	↓		0.2	0.5	%
21	Output noise level	V _{noe}	Rg=1kΩ (IHF-A filter)	↓		-57	-51	dBs

<ALC - LINE>

No.	Item	Symbol	Conditions		Min.	Typ.	Max.	Unit
			Input	Test point				
22	Line output level	V _{o1}	400Hz, -38dBs	TP6	-8.5	-7.0	-5.5	dBs
23	Line output noise level 1	V _{no1}	Rg=1kΩ (IHF-A filter) LINE input	↓		-79	-74	dBs
24	Line output noise level 2	V _{no2}	Rg=1kΩ (IHF-A filter) MIC input	↓		-76	-71	dBs
25	Line output distortion factor	THDL	400Hz, -38dBs	↓		0.1	0.4	%
26	Earphone output level	V _{oep}	400Hz, -38dBs	TP7	-27.5	-26.0	-24.5	dBs

<LINE AMP>

27	Line maximum output	V _{1max}	400Hz, THD=1%	TP6	0.5	2.5		dBs
----	---------------------	-------------------	---------------	-----	-----	-----	--	-----

<FM MOD>

28	Oscillator frequency 1 NTSC 1.5 MHz	Fr1	3.579545MHz	TP2	1.4995	1.5000	1.5005	MHz
29	Oscillator frequency 2 NTSC 1.7 MHz	Fr2	3.579545MHz	↓	1.6995	1.7000	1.7005	MHz
30	Oscillator frequency 3 PAL 1.5 MHz	Fr3	4.433619MHz	↓	1.4995	1.5000	1.5005	MHz
31	Oscillator frequency 4 PAL 1.7 MHz	Fr4	4.433619MHz	↓	1.6995	1.7000	1.7005	MHz
32	Output level 1.5/1.7	V _{or}	3.579545MHz	↓	300	340	380	mVp-p
33	Secondary distortion	HD2nd	3.579545MHz	↓		-46	-40	dB
34	Tertiary distortion	HD3rd	3.579545MHz	↓		-31	-25	dB

PB MODE <demodulator>

35	Output level	V _{dem}	fc=1.5M, fs=1k, 60kHz FM, 30mVp-p	TP8	-16.0	-15.0	-14.0	dBs
36	Output distortion factor	THDd	fc=1.5M, fs=1k, 60kHz FM, 30mVp-p	TP6		0.26	0.4	%
37	Output noise level	V _{nod}	fc=1.5M, 30mVp-p, (IHF-A filter)	TP8		-71	-64	dBs
38	AM rejection	AMR	fc=1.5M, fs=1k, 30mVp-p, 30% AM	↓		-71	-64	dBs

<LPF output frequency characteristics>

No.	Item	Symbol	Conditions		Min.	Typ.	Max.	Unit
			Input	Test point				
39	30kHz LPF1	LPF1	fc=1.5M, fs=10k, 60kHz FM, 30mVp-p	TP8	-16.0	-15.0	-14.0	dBs
40	30kHz LPF2	LPF2	fc=1.5M, fs=30k, 60kHz FM, 30mVp-p	↓	-17.5	-16.5	-15.5	dBs
41	LP emphasis on	LPE	fc=1.5M, fs=7k, 60kHz FM, 30mVp-p	↓	-19.5	-17.5	-15.5	dBs

<FM AGC>

42	AGC output level 1	AGC1	fc=1.5M, 30mVp-p	TP1	200	250	300	mVp-p
43	AGC output level 2	AGC2	fc=1.5M, 7mVp-p	↓	140	170	200	mVp-p
44	AGC output level 3	AGC3	fc=1.5M, 12mVp-p	↓	200	250	300	mVp-p
45	AGC output level 4	AGC4	fc=1.5M, 100mVp-p	↓	200	250	300	mVp-p

<BPF>

46	1.5MHz±100kHz	BPF2	fc=1.5MHz±100kHz, 7mVp-p	TP1	-6	-5	-3	dB
47	1.5MHz±200kHz	BPF3	fc=1.5MHz±200kHz, 7mVp-p	↓		-15.5	-14.5	dB
48	1.2MHz TRAP	TRAP1	fc=1.2MHz, 7mVp-p	↓		-38	-31	dB
49	1.8MHz TRAP	TRAP2	fc=1.8MHz, 7mVp-p	↓		-35	-30	dB
50	BPF OFF GAIN	VGBPF	fc=1.8MHz, 7mVp-p (=0dB)	↓	26.0	28.0	30.0	dB

<DO, MUTE>

51	DO detector on level	DOon	fc=1.5MHz, level of AGC shoulder (=0dB)	IN1	-10	-7.5	-5	dB
52	DO hysteresis	DOoff	fc=1.5MHz, with DO on level as 0 dB	↓	1	3.5	6	dB
53	Mute on time	T _{mon}	※ 1	↓	140	220	300	μsec
54	Mute hold time	T _{mh}	※ 1	↓	130	150	170	msec
55	PG doubler pulse width 1	T _{pgw} 1	fc=1.5MHz, 30mVp-p	TP4	5.0	7.0	9.0	μsec
56	PG doubler pulse width 2	T _{pgw} 2	fc=1.5MHz, 30mVp-p	↓	5.5	7.5	9.5	μsec
57	PG doubler pulse width 3	T _{pgw} 3	fc=1.5MHz, 30mVp-p	↓	6.7	8.7	10.7	μsec
58	PG doubler delay time 1	T _{pgt} 1	fc=1.5MHz, 30mVp-p	↓	1.0	2.0	3.0	μsec
59	PG doubler delay time 2	T _{pgt} 2	fc=1.5MHz, 30mVp-p	↓	1.0	2.0	3.0	μsec
60	PG doubler delay time 3	T _{pgt} 3	fc=1.5MHz, 30mVp-p	↓	1.0	2.0	3.0	μsec

<ADJ>

No.	Item	Symbol	Conditions		Min.	Typ.	Max.	Unit
			Input	Test point				
61	I0 adj variable width	I0	IN6 variable	IN6	1.85	3.3	V _{CC}	V
62	DEV adj variable width	DEV	IN2 variable, 400Hz, -15dBs	IN2	1.85	3.3	V _{CC}	V
63	Fade control variable width	FADE	IN4 variable, 400Hz, -38dBs	IN4	1.85	3.3	V _{CC}	V

<POWER MUTE>

64	Power mute on resistor 1	R _{pm 1}		TP5		20	30	Ω
65	Power mute on resistor 2	R _{pm 2}		TP7		20	30	Ω

※ 1

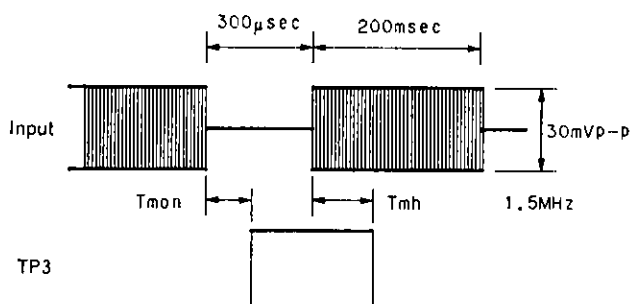

Electrical Measurements

Switch Mode Table

MODE	INPUT POSITION		
	HIGH	OPEN	LOW
	4.0V~V _{CC}		0V~0.5V
PB/REC	PB	REC	
SELECT	MIC	LINE	
AUDIO MUTE	MUTE ON		MUTE OFF
FADE	ADJUST		
SP/LP	SP	LP	
NTSC/PAL	NTSC	PAL	
1.5M BPF ON/1.5M BPF OFF/1.7M	1.5M BPF ON	1.5M BPF OFF	1.7M
STAND BY	OFF	ON	

Test Program Table

No.	Switch No.															Input point	Remarks
	1	2	3	4	5	6	7	8	9	10	11	12	13	14	15		
1	b	a	b	a	b	OFF	b	a	b	b	b	b	a	b	a		
2	↓	↓	↓	↓	↓	↓	a	↓	↓	↓	↓	↓	↓	↓	↓		
3	a	↓	↓	↓	↓	↓	↓	↓	↓	↓	↓	↓	↓	↓	↓		
4	↓	b	↓	↓	↓	↓	↓	↓	↓	↓	↓	↓	↓	↓	↓		
5	b	a	↓	↓	↓	↓	↓	↓	↓	↓	↓	↓	↓	↓	↓		
6	↓	↓	↓	↓	↓	↓	↓	↓	↓	↓	↓	↓	↓	↓	↓		
7	↓	↓	↓	↓	↓	↓	c	↓	↓	↓	a	↓	↓	↓	↓		
8	↓	↓	↓	↓	↓	↓	↓	↓	↓	↓	b	b	a	↓	↓		
9	↓	↓	↓	↓	↓	↓	↓	↓	↓	↓	↓	a	↓	↓	↓		
10	↓	↓	↓	↓	↓	↓	↓	↓	↓	↓	a	b	b	↓	↓		
11	↓	↓	↓	↓	↓	↓	↓	↓	↓	↓	↓	a	a	↓	↓		
12	↓	↓	↓	↓	↓	↓	↓	↓	↓	↓	↓	↓	↓	↓	↓		
13	↓	↓	↓	↓	↓	↓	↓	↓	a	↓	↓	↓	↓	↓	↓		
14	↓	↓	↓	↓	↓	↓	↓	↓	b	↓	↓	↓	↓	↓	↓		
15	↓	↓	↓	↓	↓	↓	↓	↓	↓	↓	↓	↓	↓	↓	↓		
16	↓	↓	↓	↓	↓	↓	↓	↓	↓	↓	↓	↓	↓	↓	↓		
17	↓	↓	↓	↓	↓	↓	↓	↓	↓	↓	↓	↓	↓	↓	↓		
18	↓	↓	↓	↓	↓	↓	↓	↓	↓	↓	↓	↓	↓	↓	↓		
19	↓	↓	↓	↓	↓	↓	a	c	↓	↓	↓	↓	↓	↓	↓		
20	↓	↓	↓	↓	↓	↓	↓	↓	↓	↓	↓	↓	↓	↓	↓		
21	↓	↓	↓	↓	↓	↓	↓	b	↓	b	↓	↓	↓	↓	↓		
22	↓	↓	↓	↓	↓	↓	↓	a	↓	↓	↓	↓	↓	↓	↓		
23	↓	↓	↓	↓	↓	↓	↓	↓	↓	↓	↓	b	↓	↓	↓		
24	↓	↓	↓	↓	↓	↓	↓	↓	↓	↓	↓	a	b	↓	↓		
25	↓	↓	↓	↓	↓	↓	↓	↓	↓	↓	↓	↓	a	↓	↓		
26	↓	↓	↓	↓	↓	↓	↓	↓	↓	↓	↓	↓	↓	↓	↓		
27	↓	↓	↓	↓	↓	OFF	↓	c	↓	a	↓	↓	↓	↓	↓		
28	↓	↓	↓	↓	a	↓	↓	a	↓	b	↓	↓	↓	↓	↓		

IN7 = 3.579545MHz

No.	Switch No.															Input point	Remarks
	1	2	3	4	5	6	7	8	9	10	11	12	13	14	15		
29	↓	b	↓	a	OFF	↓	a	b	b	b	b	a	a	a	a		IN7 = 3.579545MHz
30	↓	a	↓	↓	↓	↓	↓	↓	↓	↓	↓	↓	↓	↓	b		IN7 = 4.433619MHz
31	↓	c	↓	↓	↓	↓	↓	↓	↓	↓	↓	↓	↓	↓	↓		IN7 = 4.433619MHz
32	↓	a/c	↓	↓	↓	↓	↓	↓	↓	↓	↓	↓	↓	a	↓		IN7 = 3.579545MHz
33	↓	a	↓	↓	↓	↓	↓	↓	↓	↓	↓	↓	↓	↓	↓		IN7 = 3.579545MHz
34	↓	↓	↓	↓	↓	↓	↓	↓	↓	↓	↓	↓	↓	↓	↓		IN7 = 3.579545MHz
35	a	↓	↓	↓	b	↓	c	↓	↓	↓	↓	↓	↓	↓	↓	IN1	
36	↓	↓	↓	↓	↓	↓	a	↓	↓	↓	↓	↓	↓	↓	↓	↓	
37	↓	↓	↓	↓	↓	↓	c	↓	↓	↓	↓	↓	↓	↓	↓		
38	↓	↓	↓	↓	↓	↓	↓	↓	↓	↓	↓	↓	↓	↓	↓	IN1	Apply 30% AM, taking 30 mVp-p as 0 dB
39	↓	↓	↓	↓	↓	↓	↓	↓	↓	↓	↓	↓	↓	↓	↓	↓	
40	↓	↓	↓	↓	↓	↓	↓	↓	↓	↓	↓	↓	↓	↓	↓	↓	
41	↓	↓	↓	b	↓	↓	↓	↓	↓	↓	↓	↓	↓	↓	↓	↓	
42	↓	↓	↓	a	↓	↓	↓	↓	↓	↓	↓	↓	↓	↓	↓	↓	
43	↓	↓	↓	↓	↓	↓	↓	↓	↓	↓	↓	↓	↓	↓	↓	↓	
44	↓	↓	↓	↓	↓	↓	↓	↓	↓	↓	↓	↓	↓	↓	↓	↓	
45	↓	↓	↓	↓	↓	↓	↓	↓	↓	↓	↓	↓	↓	↓	↓	↓	
46	↓	↓	↓	↓	↓	↓	↓	↓	↓	↓	↓	↓	↓	↓	↓	↓	Attenuation from 1.5 M Hz
47	↓	↓	↓	↓	↓	↓	↓	↓	↓	↓	↓	↓	↓	↓	↓	↓	Attenuation from 1.5 M Hz
48	↓	↓	↓	↓	↓	↓	↓	↓	↓	↓	↓	↓	↓	↓	↓	↓	Attenuation from 1.5 M Hz
49	↓	↓	↓	↓	↓	↓	↓	↓	↓	↓	↓	↓	↓	↓	↓	↓	Attenuation from 1.5 M Hz
50	↓	b	↓	↓	↓	↓	↓	↓	↓	↓	↓	↓	↓	↓	↓	↓	
51	↓	a	a	↓	↓	↓	↓	↓	↓	↓	↓	↓	↓	↓	↓	↓	IN1 level for TP4 to switch from high to low.
52	↓	↓	↓	↓	↓	↓	↓	↓	↓	↓	↓	↓	↓	↓	↓	↓	IN1 level for TP4 to switch from low to high.
53	↓	↓	↓	↓	b	↓	↓	↓	↓	↓	↓	↓	↓	↓	↓	↓	
54	↓	↓	↓	↓	↓	↓	↓	↓	↓	↓	↓	↓	↓	↓	↓	↓	
55	↓	↓	↓	↓	↓	↓	↓	↓	↓	↓	↓	↓	↓	↓	↓	↓	
56	↓	b	↓	↓	↓	↓	↓	↓	↓	↓	↓	↓	↓	↓	↓	↓	

No.	Switch No.															Input point	Remarks
	1	2	3	4	5	6	7	8	9	10	11	12	13	14	15		
57	a	c	a	a	b	OFF	a	c	b	b	b	b	a	a	a	IN1	
58	↓	↓	↓	↓	↓	↓	↓	↓	↓	↓	↓	↓	↓	↓	↓	↓	
59	↓	↓	↓	↓	↓	↓	↓	↓	↓	↓	↓	↓	↓	↓	↓	↓	
60	↓	↓	↓	↓	↓	↓	↓	↓	↓	↓	↓	↓	↓	↓	↓	↓	
61	b	a	↓	↓	↓	↓	↓	↓	↓	↓	↓	↓	↓	↓	↓		Voltage on IN6 for the voltage on TP11 to become 2.20 V.
62	↓	↓	↓	↓	↓	↓	↓	↓	↓	a	↓	↓	↓	↓	↓	IN5	Voltage on IN2 for the deviation on TP2 to become 1.5 MHz ±60.
63	↓	↓	↓	↓	↓	↓	↓	↓	↓	b	↓	↓	↓	↓	↓	↓	Voltage on IN4 for the output level on TP8 to go from -15 dBs to -80 dBs.
64	↓	↓	↓	↓	↓	↓	↓	↓	a	b	↓	↓	↓	↓	↓	↓	Computation from TP5 and TP6.
65	↓	↓	↓	↓	↓	↓	↓	↓	↓	↓	↓	↓	↓	↓	↓	↓	Computation from TP6 and TP7.

Electrical Test Circuit

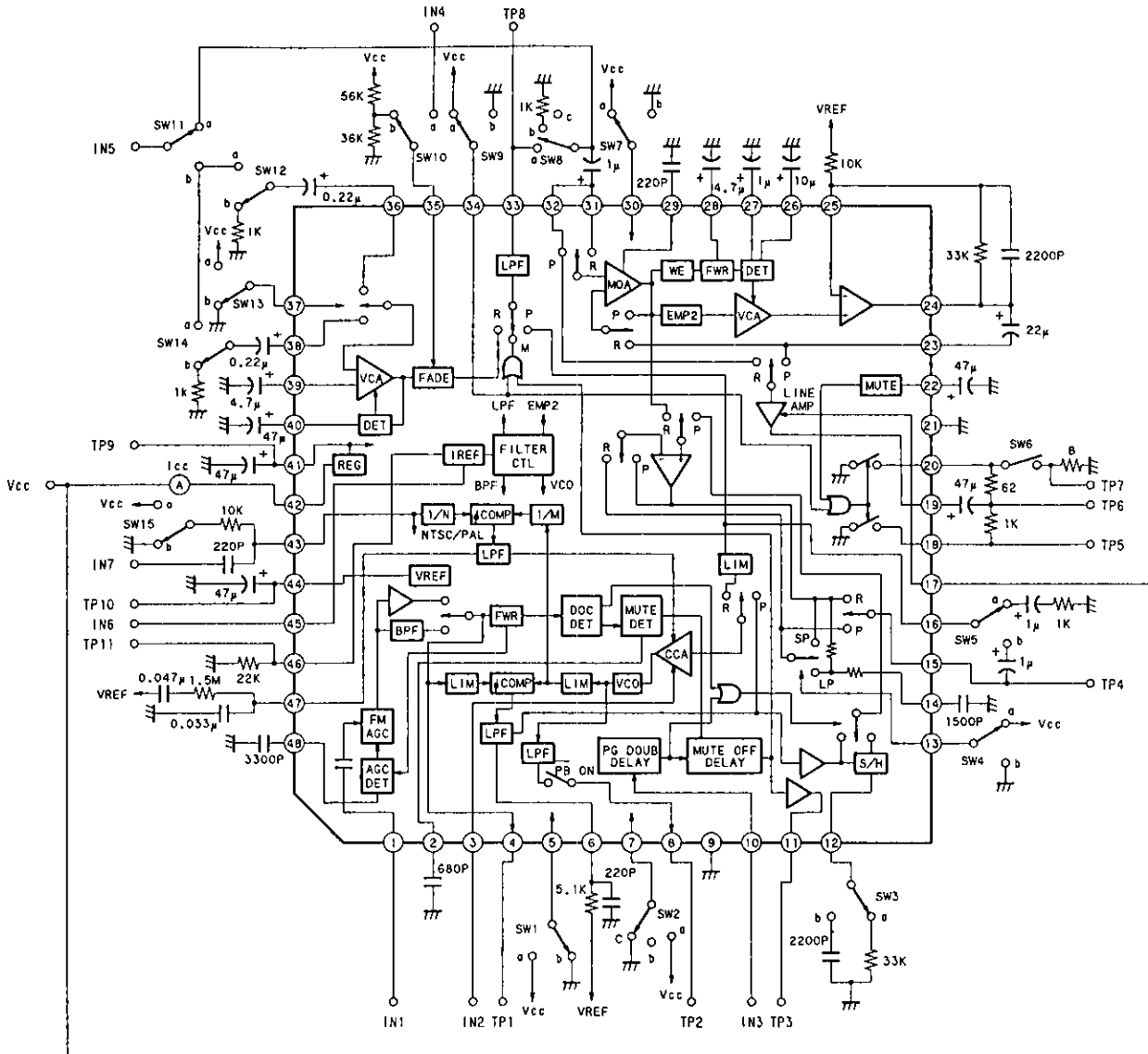

Note: If monitoring Pin 4, connect a resistor of approximately 10 kΩ between this pin and ground.



LittleDiode supplies new, hard to find or obsolete electronic components and semiconductors all over the world.

With over two million different components listed you are sure to find the part you need.

Feel free to visit us today at our online store:

LittleDiode.com

Looking forward to providing you with the best possible service.