

SONY

CXA1156AQ

8-bit 400MSPS Triple VIDEO D/A Converter

Description

The CXA1156AQ is an 8-bit high-speed D/A converter with input/output of 3 channels for RGB.

This IC achieves maximum conversion rate of 400MSPS, and is suitable for signal processing applications requiring high speed and resolution such as high resolution monitors and high definition video systems.

Features

- High speed: 400MSPS
- High resolution: 8-bit RGB
- Low power consumption: 1.3W (at $V_{EE} = -4.5V$)
- Video control inputs: Sync, Blank, Overlay
- ECL 100K and 10K compatible inputs
- 25Ω, 37.5Ω load driving capability
- Differential current output
- RS-343A compatible output

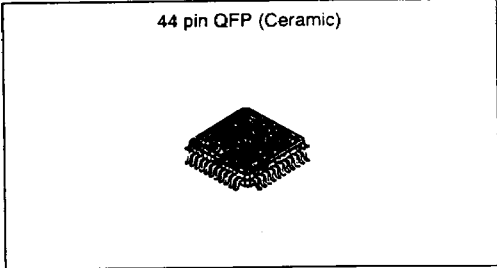

Function

8-bit 400MSPS triple video D/A converter

Structure

Bipolar silicon monolithic IC

Block Diagram/Pin Configuration

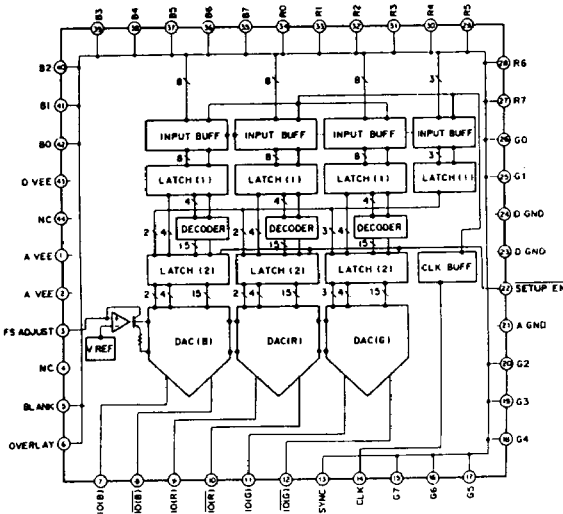

Absolute Maximum Ratings (Ta=25°C)

• Supply voltage	AV _{EE} , DV _{EE}	-7 to +0.5	V
• Input voltage (digital)	V _I	DV _{EE} to +0.5	V
(FS. ADJ. pin)	V _{REF}	AV _{EE} to +0.5	V
• Input current (FS. ADJ. pin)	I _{REF}	2.0	mA
• Output voltage	V _O	-2.0 to +2.0	V
• Output current	I _O	50	mA
• Storage temperature	T _{stg}	-65 to +150	°C
• Allowable power dissipation	P _D	1.3	W

Operating Conditions

• Supply voltage	AV _{EE} , DV _{EE}	-4.8 to -4.2	V
	AV _{EE} -DV _{EE}	-0.05 to +0.05	V
• Digital input voltage	V _{IH}	-1.05 to -0.7	V
	V _{IL}	-1.9 to -1.49	V
• Reference current	I _{REF}	0.5 to 1.9	mA
• Load resistance	R _L	25 to 37.5	Ω
• Output voltage	V _O (FS.)	0.8 to 1.2	V
• CLK pulse width	tpw ₁	1.2 (Min.)	ns
	tpw ₀	1.2 (Min.)	ns
• Operating temperature	T _c	-20 to 70	°C

Maximum Allowable Power Dissipation vs. Ambient Temperature

- With fin 2290C (*)
 - With fin 2285C (*)
 - Without fin
 - When not mounted
- } When mounted on a board (**)

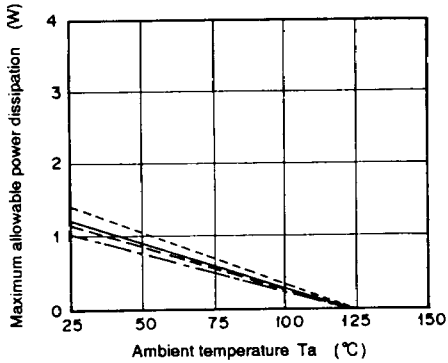

(a) In Still Air

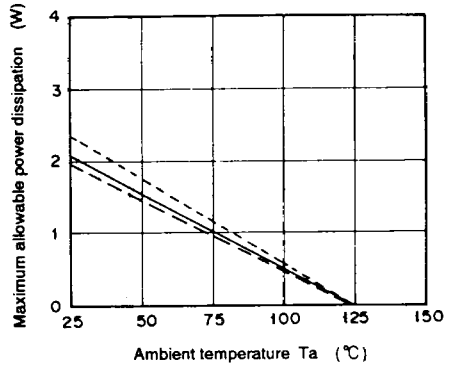

(b) Air Flow Rate 1.5m/sec

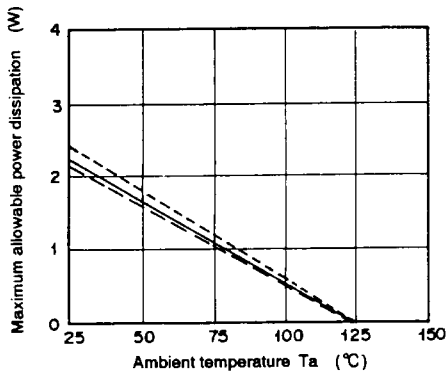

(c) Air Flow Rate 3.0m/sec

* Manufactured by Thermalloy Inc.

** PCB area 20 × 10 × 1.6mm
1-sided glass fiber epoxy board with 30% copper foil area

Pin Description and Input/Output Equivalent Circuit

Pin No.	Symbol	Pin voltage	Equivalent circuit	Description
1 2	AV _{EE}	-4.5V (typ.)		Analog power supply.
3	FS ADJUST	-1.3V (typ.)		Controls full-scale level for the D/A converter output. Output current can be adjusted by the resistor value externally connected between this pin and AGND. See the section on Description of Operation for details on how the external resistance should be selected.
4	NC			Unconnected pin. Leave this pin open.
5	BLANK	ECL		Control input for "blank". Setting the input to "1" fixes the D/A output to BLANK level regardless of input data for gray level. When the pin is left open, it functions as when it is set to "0". (See Input / Output Table)
6	OVERLAY	ECL		Control input for "overlay". Setting the input to "1" enhances the D/A output to level of 10% brighter than WHITE level regardless of input data for gray level. When the pin is left open, it functions as when it is set to "0". (See Input / Output Table)

6

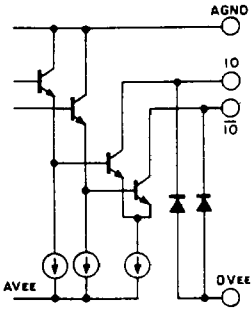
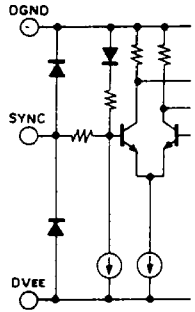
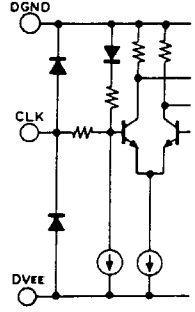
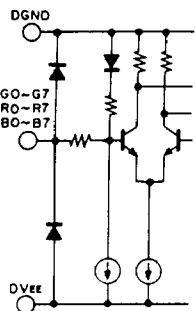
Pin No.	Symbol	Pin voltage	Equivalent circuit	Description
7, 8 9, 10 11, 12	IO (B), $\overline{\text{IO}}(\text{B})$ IO (R), $\overline{\text{IO}}(\text{R})$ IO (G), $\overline{\text{IO}}(\text{G})$	0 to -1071mV (typ.)		Complementary analog current outputs for red, green and blue (RGB). Output voltages are acquired when they are connected to external pull-up resistors.
13	SYNC	ECL		Control input for "composite sync". This functions only for IO (G), $\overline{\text{IO}}(\text{G})$ output. Setting the input to "1" fixes the D/A output to SYNC level regardless of input data for gray level. When the pin is left open, it functions as when it is set to "0". (See Input / Output Table)
14	CLK	ECL		Clock input. All data and control inputs are latched by the rising edge of CLK. When the pin is left open, it functions as when it is set to "0".
26, 25 20 to 15	G0 to G7	ECL		Digital input for gray level. G0 (LSB) to G7 (MSB) input for GREEN. R0 (LSB) to R7 (MSB) input for RED. B0 (LSB) to B7 (MSB) input for BLUE. When the pin is left open, it functions as when it is set to "0". (See Input / Output Table)
34 to 27	R0 to R7			
42 to 35	B0 to B7			

Pin No.	Symbol	Pin voltage	Equivalent circuit	Description
21	AGND	GND		Analog GND. Separated from DGND.
22	SETUP EN			Setting this pin to "1" or DGND makes BLANK level equal to BLACK level. Setting this pin to "0" or open makes BLANK level lower than BLACK level by 7.5IRE. (see Fig. 1 to 4)
23, 24	DGND	GND		Digital GND. Separated from AGND.
43	DV _{EE}	-4.5V (typ.)		Digital power supply. Separated from AV _{EE} .
44	NC			Unconnected pin.

Electrical Characteristics

(A_{VEE}=D_{VEE}=-4.5V, T_a=25 °C)

Item	Symbol	Conditions	Min.	Typ.	Max.	Unit
Resolution	n		8	8	8	bit
Integral linearity error	E _L	V _{FS} =661mV			± 1/2	LSB
Differential linearity error	E _D				± 1/2	LSB
Digital input current	I _{IH}	V _{IN} =-0.7V	0		180	μA
	I _{IL}	V _{IN} =-1.9V	-100		100	μA
Digital input capacitance	C _{IN}			5		pF
Maximum output current	I _O		48			mA
Output compliance voltage	V _{OC}		-1.2		1.5	V
Output resistance	R _O			50		kΩ
Output capacitance	C _O			10		pF
Output current		V _{FS} =661mV				
Full gray scale error	E _{FS}		-10	0	10	% of Gray Scale
Full gray scale balance (G, R, B) (Note 1)	E _{FSB}		0	0.5	2.5	% of Gray Scale
Full gray scale temperature coefficient	T _{CFS}			+0.06		% of Gray Scale/°C
Offset current	I _{OF}		0		40	μA
Power supply current	I _{EE}		-430	-310	-200	mA
Maximum conversion rate	F _{S MAX}		400			MSPS
Set-up time (Note 2)	t _S	Digital input/clock threshold voltage =-1.3V R _L =25Ω	1.0			ns
Hold time (Note 2)	t _H		0.6			ns
Output rise time	t _R			0.5	0.9	ns
Output fall time	t _F			0.5	0.9	ns
Output delay	t _D		2.1	2.8	3.4	ns
Output pipeline delay	t _{PLD}		1	1	1	Clock

Note 1) $E_{FSB} = \frac{\max\{|V_{FS}(G) - V_{FS}(R)|, |V_{FS}(R) - V_{FS}(B)|, |V_{FS}(B) - V_{FS}(G)|\}}{\{V_{FS}(G) + V_{FS}(R) + V_{FS}(B)\}/3} \times 100$

V_{FS} is full gray scale that is voltage difference between WHITE and BLACK level.

Note 2) Specified at -20 ≤ T_C ≤ 70 °C

Description of Operation (See Block Diagram / Pin Configuration)

Each of RGB DATA (R0 to R7, G0 to G7, B0 to B7) and CONTROL signals (SYNC, BLANK, OVERLAY) are caught at the rising edge of CLK by LATCH (1).

The upper 4 bits of each DATA, which have been decoded into thermometer code in DECODER section, are transferred to DAC section via LATCH (2), together with the lower 4 bits and CONTROL signals.

DAC section creates analog current output composing of the following portions:

- Weighted lower 4-bit current
- Thermometer-coded upper 4-bit current
- Function output current

The output appears delayed by 1clock after the rising edge of CLK.

This analog current output is converted to voltage output by load resistor RL that is connected to the output pin.

Output full scale adjustment is possible by setting the value of Rset (shown in the formula below) located between FS ADJUST pin and AGND. The FS ADJUST voltage is produced by an internal band-gap voltage source.

$$R_{set} = \frac{V_{ADJ}}{\frac{V_{FS}}{R_L} \times \frac{16}{255}} \quad [\Omega]$$

Here, V_{FS} represents typical voltage difference between WHITE level and BLACK level. V_{ADJ} is voltage at FS ADJUST pin.

For instance, R_{set} is approximately 750Ω for V_{FS}=661mV.

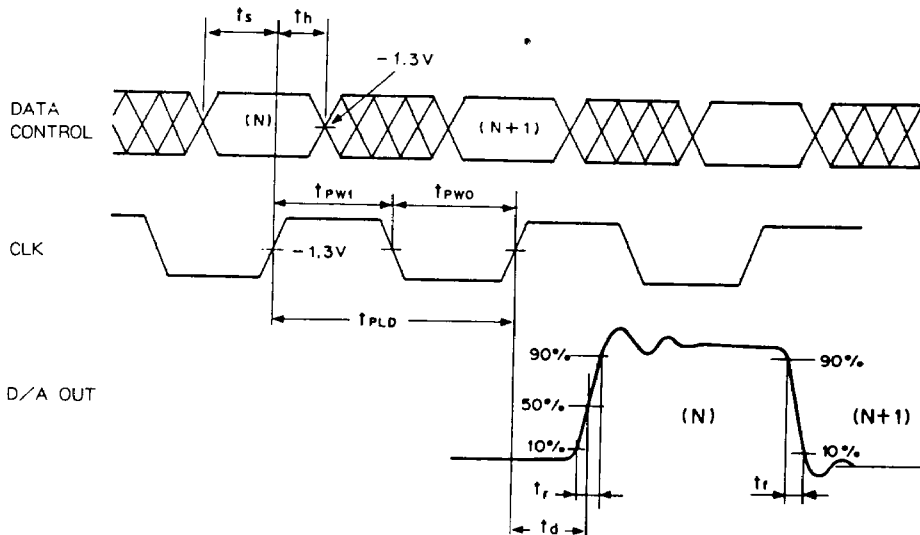

Timing Diagram



Output Levels (With SETUP function)

$\overline{IO}(G)$ (mA)	$VO(G)$ (V)
0.00	0.000
-2.84	-0.071
-29.28	-0.732
-31.42	-0.785
-42.84	-1.071

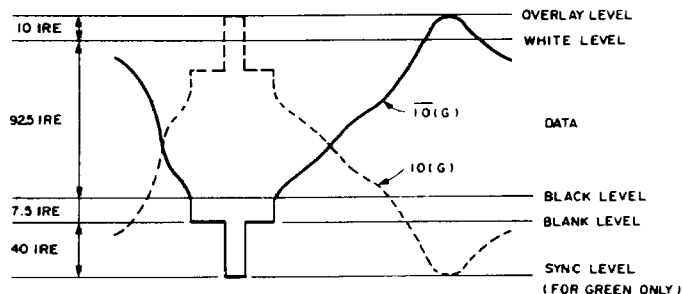

* In case of doubly-terminated 50 Ω load.

Fig. 1. Composite Video Output Level (GREEN)

	$\overline{IO}(G)$ (mA)	$IO(G)$ (mA)	SETUP EN	OVERLAY	SYNC	BLANK	D/A Input Data
OVERLAY	0.00	-42.84	0	1	0	0	x x x x x x x x
WHITE	-2.84	-40.00	0	0	0	0	1 1 1 1 1 1 1 1
DATA			0	0	0	0	data
BLACK	-29.28	-13.56	0	0	0	0	0 0 0 0 0 0 0 0
BLANK	-31.42	-11.42	0	x	0	1	x x x x x x x x
SYNC	-42.84	0.00	0	x	1	x	x x x x x x x x

Table 1. Input/Output Table (GREEN)

$\overline{IO(R)},$ $\overline{IO(B)}$ (mA)	$\overline{VO(R)},$ $\overline{VO(B)}$ (V)
0.00	0.000
-2.84	-0.071
-29.28	-0.732
-31.42	-0.785

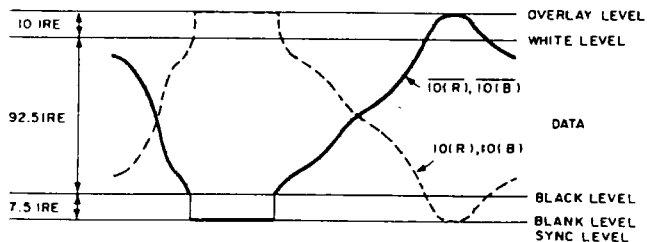

* In case of doubly-terminated 50 Ω load.

Fig. 2. Composite Video Output Level (RED, BLUE)

	$\overline{IO(R)},$ $\overline{IO(B)}$ (mA)	$IO(R),$ $IO(B)$ (mA)	$\overline{SETUP EN}$	OVERLAY	SYNC	BLANK	D/A Input Data
OVERLAY	0.00	-31.42	0	1	0	0	x x x x x x x x
WHITE	-2.84	-28.58	0	0	0	0	1 1 1 1 1 1 1 1
DATA			0	0	0	0	data
BLACK	-29.28	-2.14	0	0	0	0	0 0 0 0 0 0 0 0
BLANK	-31.42	0.00	0	x	0	1	x x x x x x x x
SYNC	-31.42	0.00	0	x	1	x	x x x x x x x x

Table 2. Input/Output Table (RED, BLUE)

Output Levels (Without SETUP function)

IO (G) (mA)	VO (G) (V)
0.00	0.000
-2.84	-0.071
-29.28	-0.732
-40.70	-1.018

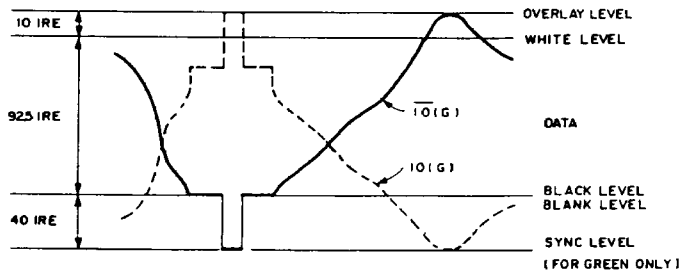

* In case of doubly-terminated 50 Ω load.

Fig. 3. Composite Video Output Level (GREEN)

	IO (G) (mA)	IO (G) (mA)	SETUP EN	OVERLAY	SYNC	BLANK	D/A Input Data
OVERLAY	0.00	-40.70	1	1	0	0	x x x x x x x x
WHITE	-2.84	-37.86	1	0	0	0	1 1 1 1 1 1 1 1
DATA			1	0	0	0	data
BLACK	-29.28	-11.42	1	0	0	0	0 0 0 0 0 0 0 0
BLANK	-29.28	-11.42	1	x	0	1	x x x x x x x x
SYNC	-40.70	0.00	1	x	1	x	x x x x x x x x

Table 3. Input/Output Table (GREEN)

$I_{O(R)}, I_{O(B)}$ (mA)	$V_{O(R)}, V_{O(B)}$ (V)
0.00	0.000
-2.84	-0.071
-29.28	-0.732

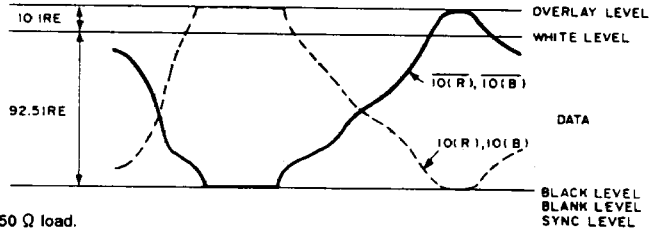

* In case of doubly-terminated 50 Ω load.

Fig. 4. Composite Video Output Level (RED, BLUE)

	$I_{O(R)}, I_{O(B)}$ (mA)	$I_{O(R)}, I_{O(B)}$ (mA)	SETUP EN	OVERLAY	SYNC	BLANK	D/A Input Data
OVERLAY	0.00	-29.28	1	1	0	0	x x x x x x x x
WHITE	-2.84	-26.44	1	0	0	0	1 1 1 1 1 1 1 1
DATA			1	0	0	0	data
BLACK	-29.28	0.00	1	0	0	0	0 0 0 0 0 0 0 0
BLANK	-29.28	0.00	1	x	0	1	x x x x x x x x
SYNC	-29.28	0.00	1	x	1	x	x x x x x x x x

Table 4. Input/Output Table (RED, BLUE)

Application Circuit (In case of using 50Ω coaxial cable for output)

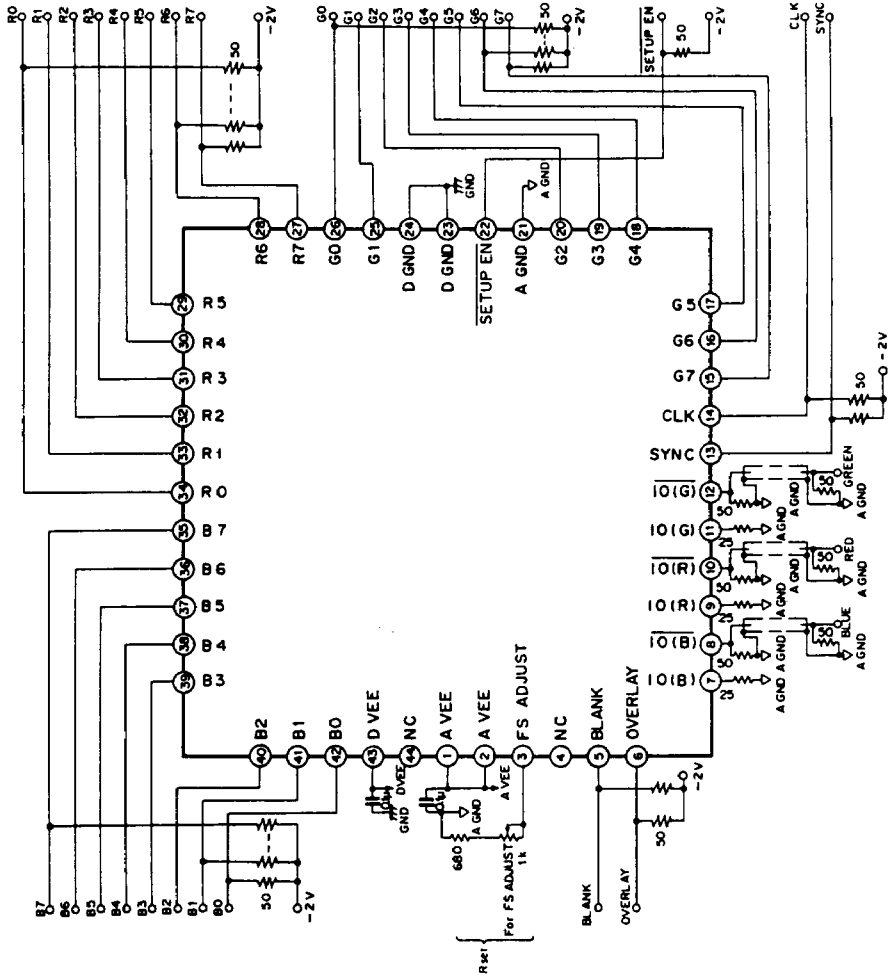

Application circuits shown are typical examples illustrating the operation of the devices. Sony cannot assume responsibility for any problems arising out of the use of these circuits or for any infringement of third party patent and other right due to same.

Notes on Operation

(1) Wiring for Digital Inputs

- All digital inputs are single-ended and ECL compatible. For high-speed operation, it is recommended that line characteristic impedance and termination resistance should be set at 50Ω . The line termination resistors should be placed nearest to the IC input pins.

(2) Noise Reduction Measures

- Use as wide GND plane as possible to reduce parasitic inductance and resistance on the board.
- It is advisable to separate AGND and DGND on the board. This also applies for AV_{EE} and DV_{EE} . Also, the connections between AGND and DGND, AV_{EE} and DV_{EE} should respectively be made at the board connector section (entrance/exit of the board).
- AV_{EE} and DV_{EE} pins should be bypassed to AGND/DGND planes of the board as close as possible to the IC, via capacitors of approximately $0.1\ \mu\text{F}$. Ceramic chip capacitors are recommended.
- V_{TT} (-2V) that is connected with termination resistors should be bypassed to DGND plane via capacitors of approximately $0.1\ \mu\text{F}$. The capacitors should be located nearest to the termination resistors. Ceramic chip capacitors are recommended.
- An external resistor R_{set} should be connected as close as possible both to FSADJ pin and AGND. The lead length of the resistor and the pattern length on the board should be as short as possible, in order to minimize noise effect. Also, any capacitors should not be connected with FSADJ pin.

(3) Analog Output Processing

This D/A converter is designed so that it is possible to directly drive 50Ω and 75Ω lines. In order to ensure line matching, it is necessary to terminate both ends of the line with 50Ω (or 75Ω), as indicated in Application Circuit.

In addition, even if some of the following outputs IO (G), $\overline{\text{IO}}(\overline{\text{G}})$, IO (R), $\overline{\text{IO}}(\overline{\text{R}})$, IO (B), $\overline{\text{IO}}(\overline{\text{B}})$ are not used, do not leave the pins open, and be sure to connect them to AGND via 25Ω or directly.

Typical Characteristics

Integral linearity error vs. T_c

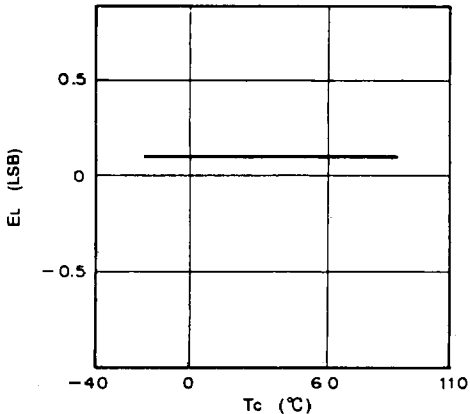

Integral linearity error vs. Supply voltage

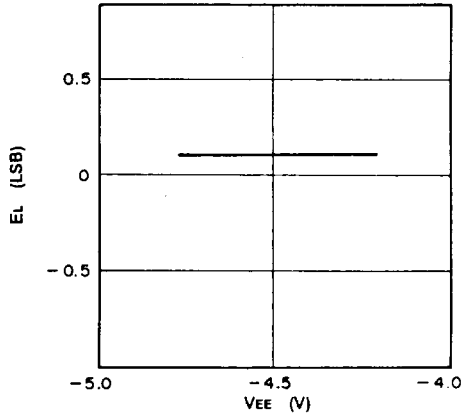

Differential linearity error vs. T_c

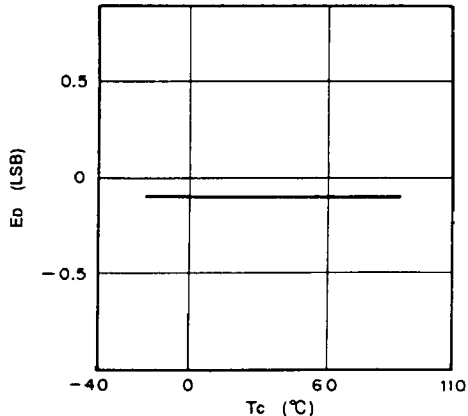

Differential linearity error vs. Supply voltage

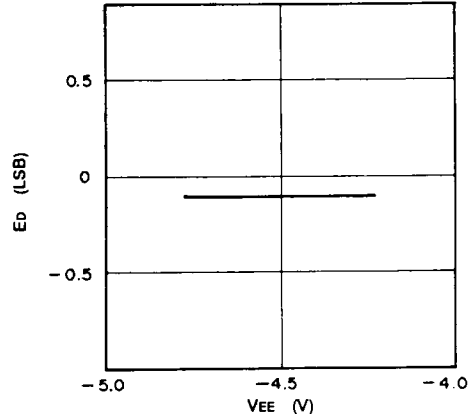

Power supply current vs. T_c

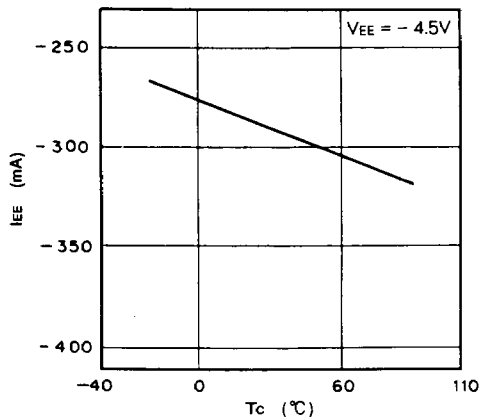

Power supply current vs. Supply voltage

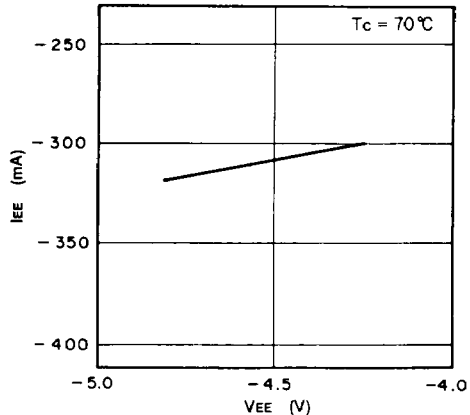

Full gray scale vs. Tc

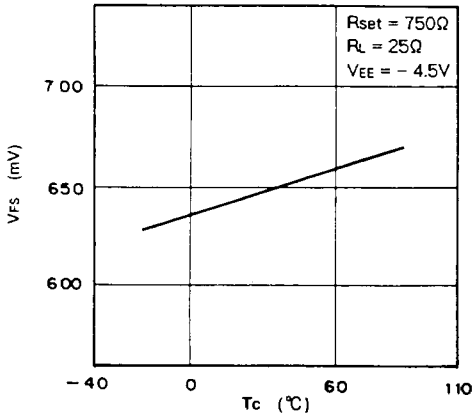

Full gray scale vs. Supply voltage

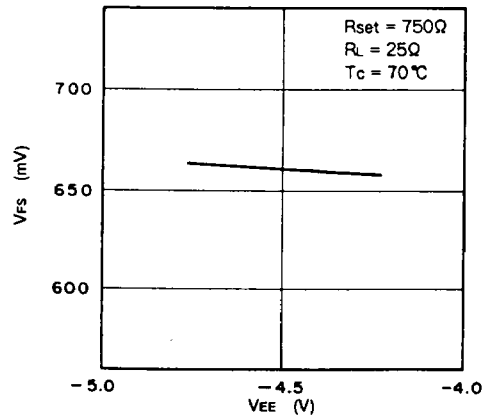

Full gray scale balance vs. Tc

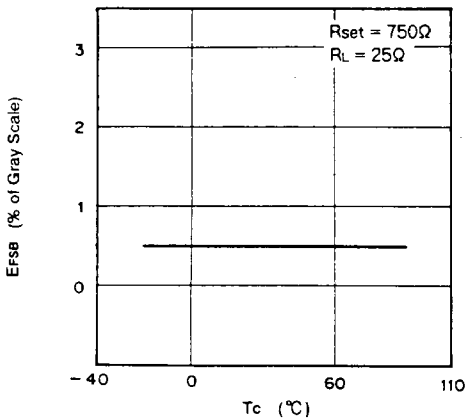

Full gray balance vs. Supply voltage

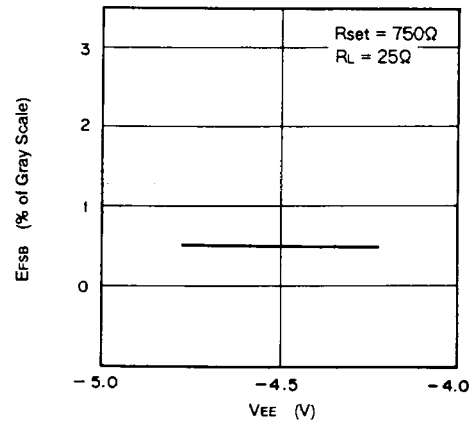

Output delay vs. Tc

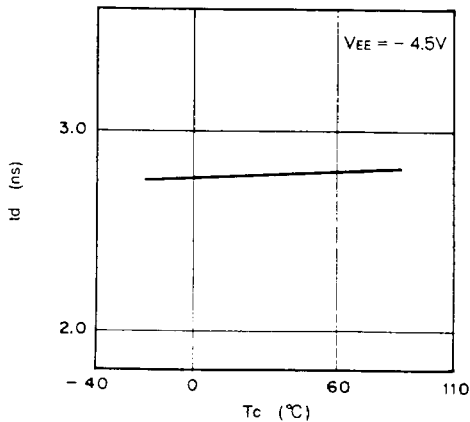

Output delay vs. Supply voltage

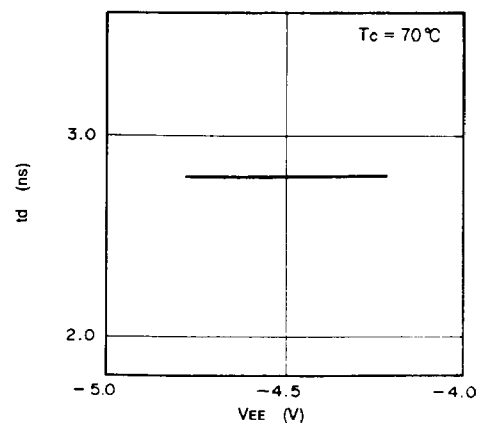

Package Outline Unit : mm

44pin QFP (Ceramic)

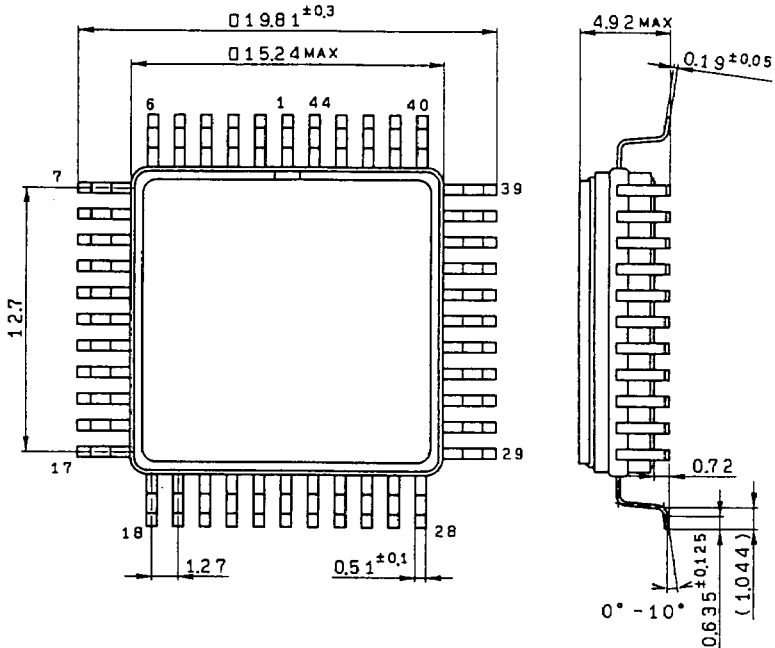











SONY NAME	QFP-44C-L01
EIAJ NAME	XQFP044-G-0000-A
JEDEC CODE	MO-084-AB*

* (Similar)

T-90-20

Sony Package Product Name

Type	Package name		Package	Features				
	Symbol	Description		Material*	Lead pitch	Lead shape	Lead pull out direction	
Inserted	Standard	DIP	DUAL IN LINE PACKAGE		P C	2.54mm (100MIL)	Through Hole Lead	2-direction
		SIP	SINGLE IN LINE PACKAGE		P	2.54mm (100MIL)	Through Hole Lead	1-direction
		ZIP	ZIG ZAG IN LINE PACKAGE		P	2.54mm (100MIL) Zig Zag inline	Through Hole Lead	1-direction
		PGA	PIN GRID ARRAY		C	2.54mm (100MIL)	Through Hole Lead	4-direction
		PIGGY BACK	PIGGY BACK		C	2.54mm (100MIL)	Through Hole Lead	2-direction
Shrink	SDIP	SHRINK DUAL IN LINE PACKAGE		P	1.778mm (70MIL)	Through Hole Lead	2-direction	
Surface mounted	Standard flat package	QFP	QUAD FLAT PACKAGE		P	1.0mm 0.8mm	Gull-Wing	4-direction
		SOP	SMALL-OUTLINE PACKAGE		P	1.27mm (50MIL)	Gull-Wing	2-direction
	Shrink flat package	VQFP	VERY SMALL QUAD FLAT PACKAGE		P	0.5mm	Gull-Wing	4-direction
		VSOP	VERY SMALL OUTLINE PACKAGE		P	0.65mm	Gull Wing	2-direction
	Standard chip carrier	PLCC	PLASTIC LEADED CHIP CARRIER		P	1.27mm (50MIL)	J-bend	4-direction
		LCC	LEAD LESS CHIP CARRIER		C	1.27mm (50MIL)	Lead less	Package side
	Shrink chip carrier	SPLCC (PLCC)	SHRINK PLASTIC LEADED CHIP CARRIER		P	1.27mm Max. (50MIL Max.)	J-bend	4-direction
	Standard 2-direction chip carrier	SOJ	SMALL OUTLINE J-LEAD PACKAGE		P	1.27mm (50MIL)	J-bend	2-direction



*P.....Plastic, C.....Ceramic

This datasheet has been downloaded from:

www.DatasheetCatalog.com

Datasheets for electronic components.



LittleDiode supplies new, hard to find or obsolete electronic components and semiconductors all over the world.

With over two million different components listed you are sure to find the part you need.

Feel free to visit us today at our online store:

LittleDiode.com

Looking forward to providing you with the best possible service.