

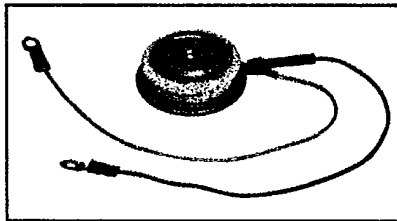

C380

Powerex, Inc. Hillis Street, Youngwood, Pennsylvania 15697 (412) 925-7272
 Powerex Europe, S.A., 428 Ave. G. Durand, BP107, 72003 LeMans, France (43) 72.75.15

Phase Control SCR
250 Amperes Avg
100-1300 Volts

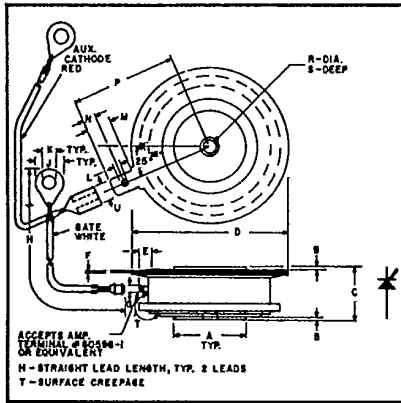

C380
Phase Control SCR
 250 Amperes/100-1300 Volts

TO-200
Outline Drawing

Dimensions	Inches		Millimeters	
	Min.	Max.	Min.	Max.
A	.744	.752	18.897	19.101
B	.030	.060	.762	1.524
C	.515	.565	13.081	14.351
D	1.600	1.656	40.64	42.06
E	.110	—	2.794	—
F	.013	.017	.330	.432
G	.057	.059	1.447	1.449
H	7.980	8.115	202.70	206.11
J	—	.300	—	7.620
K	.137	.153	3.479	3.886
L	.065	.070	1.651	1.778
M	.245	.260	6.223	6.604
N	.120	.140	3.048	3.556
P	1.090	1.125	27.69	28.55
R	.135	.145	3.429	3.683
S	.067	.083	1.701	2.108
T	.340	—	8.636	—
U	.186	.189	4.724	4.801

Description

Powerex Silicon Controlled Rectifiers (SCR) are designed for phase control applications. These are all-diffused, Press-Pak (Pow-R-Disc) devices employing the field-proven amplifying (di/namic) gate.

Features:

- Low On-State Voltage
- High di/dt
- High dv/dt
- Hermetic Packaging
- Excellent Surge and I²t Ratings

Applications:

- Power Supplies
- Battery Chargers
- Motor Control
- Light Dimmers
- VAR Generators

Ordering Information

Example: Select the complete five or six digit part number you desire from the table - i.e. C380M is a 600 Volt, 250 Ampere Phase Control SCR.

Type	Voltage		Current
	V _{ORM} V _{RRM}	Code	
C380	100	A	250
	200	B	
	300	C	
	400	D	
	500	E	
	600	M	
	700	S	
	800	N	
	900	T	
	1000	P	
	1100	PA	
	1200	PB	
	1300	PC	



T-25-19

Powerex, Inc., Hillis Street, Youngwood, Pennsylvania 15697 (412) 925-7272

Powerex Europe, S.A., 428 Ave. G. Durand, BP107, 72003 LeMans, France (43) 72.75.15

C380

Phase Control SCR

250 Amperes Avg/100-1300 Volts

Absolute Maximum Ratings

	Symbol	C380	Units
RMS On-State Current	$I_{T(RMS)}$	400	Amperes
Average On-State Current	$I_{T(av)}$	250	Amperes
Peak One-Cycle Surge (Non Repetitive) On-State Current (60Hz)	I_{TSM}	3500	Amperes
Peak One-Cycle Surge (Non-Repetitive) On-State Current (50Hz)	I_{TSM}	3200	Amperes
Critical Rate-of-Rise of On-State Current (Non-Repetitive)	di/dt	800	Amperes/ μ s
Critical Rate-of-Rise of On-State Current (Repetitive)	di/dt	500	Amperes/ μ s
I^2t (for Fusing), 8.3 milliseconds	I^2t	50,000	A^2sec
Peak Gate Power Dissipation	P_{GM}	10	Watts
Average Gate Power Dissipation	$P_{G(av)}$	2	Watts
Storage Temperature	T_{STG}	-40 to 150	$^{\circ}C$
Operating Temperature	T_J	-40 to 125	$^{\circ}C$
Mounting Force [ⓐ]		720 to 880	lb.
Mounting Force [ⓐ]		3.2 to 3.92	kN

[ⓐ] Consult recommended mounting procedures.



Powerex, Inc., Hillis Street, Youngwood, Pennsylvania 15697 (412) 925-7272

Powerex Europe, S.A., 428 Ave. G. Durand, BP107, 72003 LeMans, France (43) 72.75.15

C380

Phase Control SCR

250 Amperes Avg/100-1300 Volts

Electrical and Thermal Characteristics

Characteristics	Symbol	Test Conditions	C380	Units
Voltage—Blocking State Maximums				
Forward Leakage, Peak	I_{DRM}	$T_J = 125^\circ\text{C}, V = V_{DRM}$	20	mA
Reverse Leakage, Peak	I_{RRM}	$T_J = 125^\circ\text{C}, V = V_{RRM}$	20	mA
Current—Conducting State Maximums				
Peak On-State Voltage	V_{TM}	$I_{TM} = 1500\text{A Peak}, T_C = 25^\circ\text{C}, \text{Duty Cycle} \leq 0.01\%$	2.85	Volts
Switching				
Typical Turn-Off Time	t_q	$T_J = 120^\circ\text{C}, I_{TM} = 250\text{ amps};$ $V_R = 50\text{ Volts Min.}; V_{DRM}$ (Reapplied); Rate-of-Rise of Reapplied Off-State; Voltage = 20 Volts/ μsec (Linear); Gate Bias During Turn-Off Interval = 0 Volts, 100 Ohms Duty Cycle $\leq 0.01\%$	200	μsec
Typical Delay Time	t_d	$T_J = 25^\circ\text{C}, I_T = 100\text{ Adc}, V_{DRM} = \text{Rated};$ Gate Supply: 10 Volt Open Circuit, 25 Ohm, 0.1 μsec max. rise time	1	μsec
Min. Critical dv/dt exponential to V_{DRM}	dv/dt	$T_J = 125^\circ\text{C}, \text{Gate Open}$	200	V/ μsec
Thermal				
Maximum Thermal Resistance [ⓐ] , double sided cooling				
Junction to Case	$R_{\theta JC}$.095	$^\circ\text{C}/\text{Watt}$
Case to Sink, Lubricated	$R_{\theta CS}$.02	$^\circ\text{C}/\text{Watt}$
Gate—Maximum Parameters				
Gate Current to Trigger	I_{GT}	$V_D = 6\text{V}, T_C = 25^\circ\text{C}, R_L = 3\Omega$	150	mA
Gate Voltage to Trigger	V_{GT}	$V_D = 6\text{V}, T_C = -40\text{ to }125^\circ\text{C}, R_L = 3\Omega$	3	Volts
Non-Triggering Gate Voltage	V_{GDM}	$T_J = 125^\circ\text{C}, \text{rated } V_{DRM}, R_L = 1000\Omega$.15	Volts
Peak Forward Gate Current	I_{GTM}		10	Amperes
Peak Reverse Gate Voltage	V_{GRM}		5	Volts

[ⓐ] Consult recommended mounting procedures.



Powerex, Inc., Hills Street, Youngwood, Pennsylvania 15697 (412) 925-7272

Powerex Europe, S.A., 428 Ave. G. Durand, BP107, 72003 LeMans, France (43) 72.75.15

C380

Phase Control SCR

250 Amperes Avg/100-1300 Volts

MAXIMUM ON-STATE CHARACTERISTICS

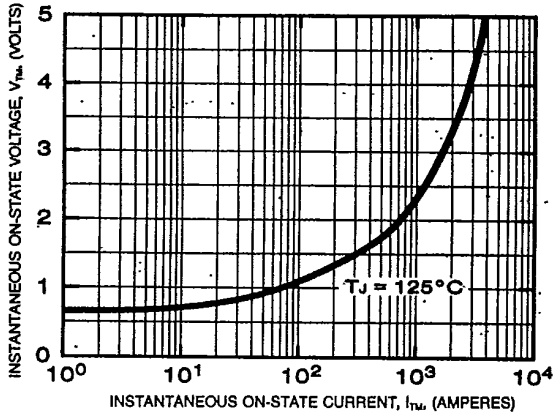

TRANSIENT THERMAL IMPEDANCE CHARACTERISTICS (JUNCTION TO CASE)

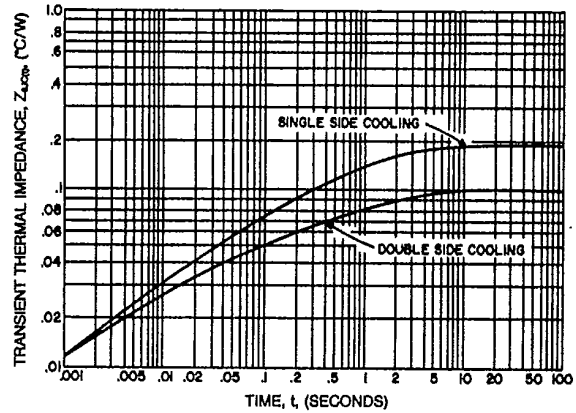

MAXIMUM ALLOWABLE CASE TEMPERATURE (SINUSOIDAL WAVEFORM)

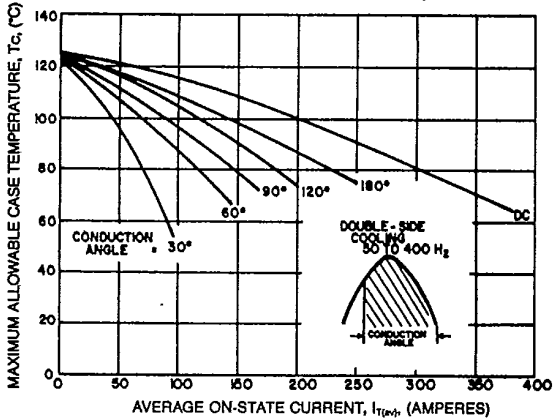

MAXIMUM ON-STATE POWER DISSIPATION (SINUSOIDAL WAVEFORM)

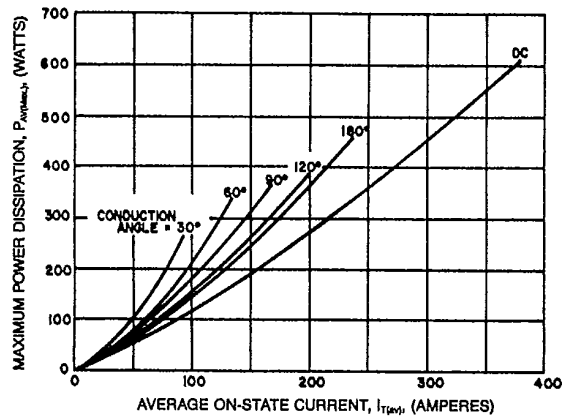

MAXIMUM ALLOWABLE CASE TEMPERATURE (RECTANGULAR WAVEFORM)

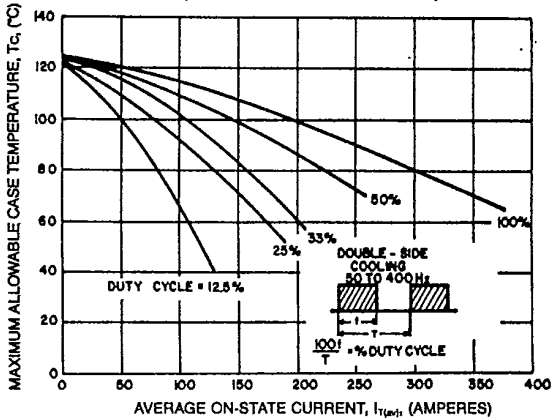

MAXIMUM ON-STATE POWER DISSIPATION (RECTANGULAR WAVEFORM)

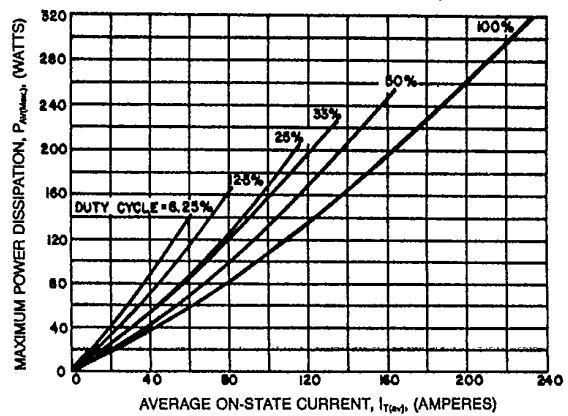



Powerex, Inc., Hillis Street, Youngwood, Pennsylvania 15697 (412) 925-7272
 Powerex Europe, S.A., 428 Ave. G. Durand, BP107, 72003 LeMans, France (43) 72.75.15

C380
 Phase Control SCR
 250 Amperes Avg/100-1300 Volts

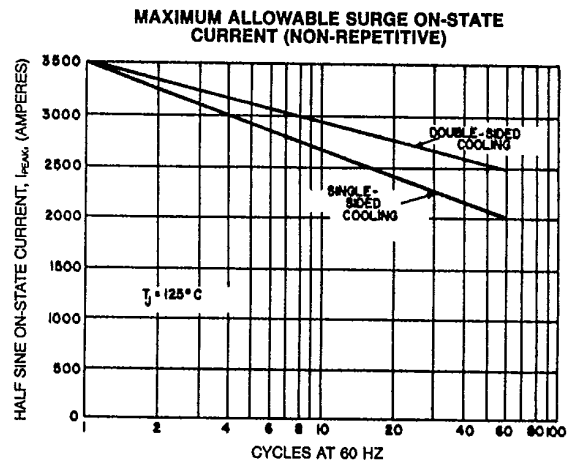
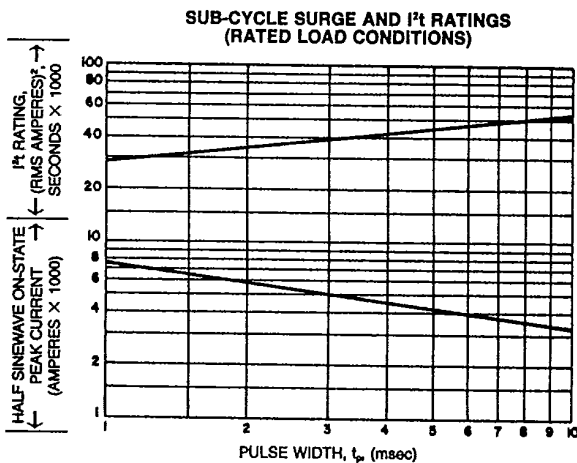
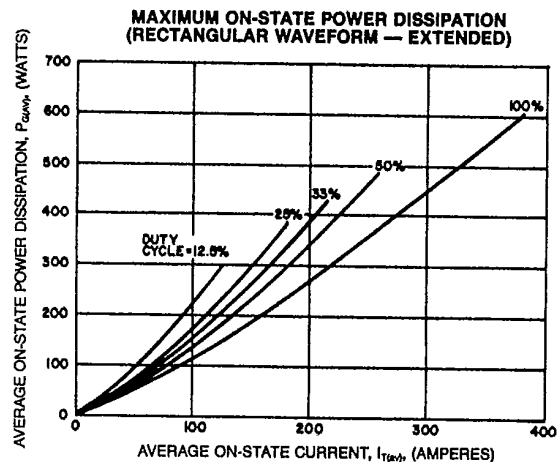
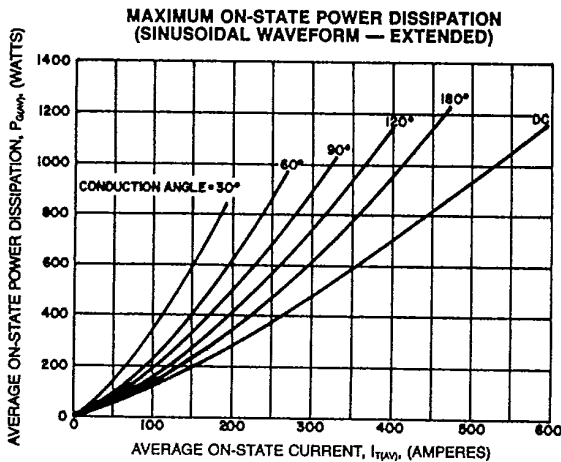
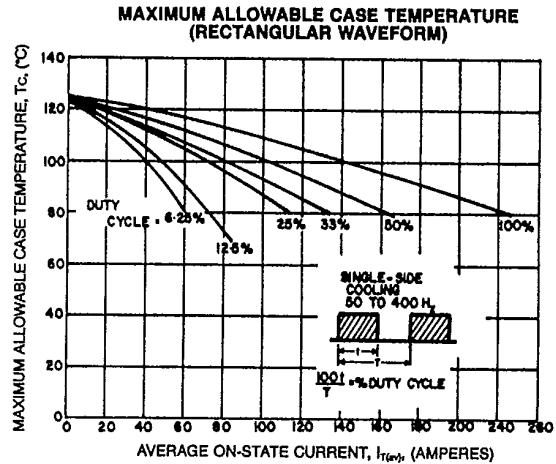
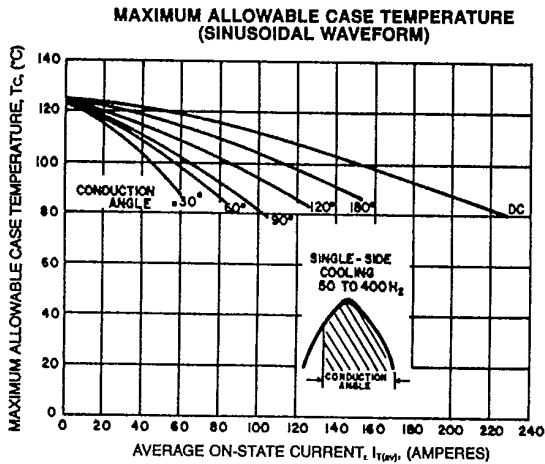



Powerex, Inc., Hillis Street, Youngwood, Pennsylvania 15697 (412) 925-7272
 Powerex Europe, S.A., 428 Ave. G. Durand, BP107, 72003 LeMans, France (43) 72.75.15

C380
 Phase Control SCR
 250 Amperes Avg/100-1300 Volts

MAXIMUM RECOVERED CHARGE

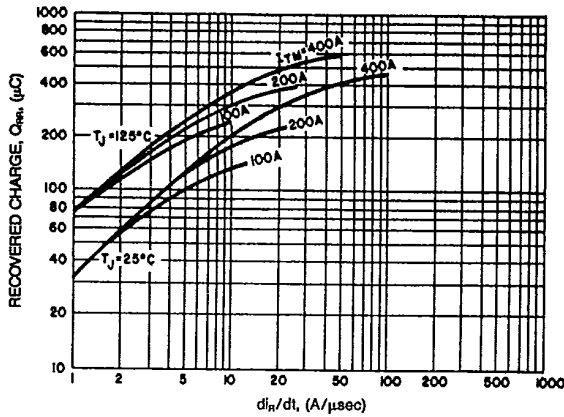

GATE CHARACTERISTICS

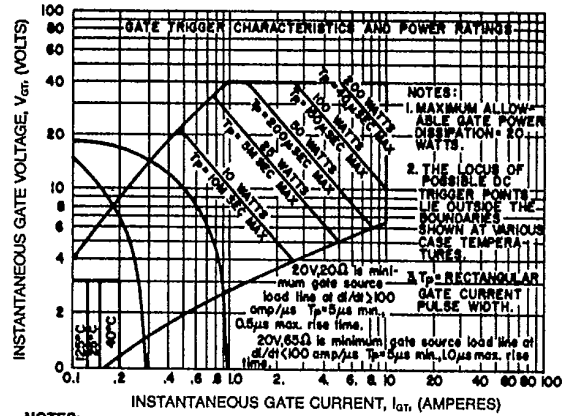

- NOTES:
1. Maximum allowable gate power dissipation = 2 watts.
 2. The locus of possible DC trigger points lie outside the boundaries shown at various case temperatures.
 3. T_p = Rectangular Gate Current Pulse Width.



LittleDiode supplies new, hard to find or obsolete electronic components and semiconductors all over the world.

With over two million different components listed you are sure to find the part you need.

Feel free to visit us today at our online store:

LittleDiode.com

Looking forward to providing you with the best possible service.