



BYT230PIV-1000 BYT231PIV-1000

FAST RECOVERY RECTIFIER DIODES

MAIN PRODUCT CHARACTERISTICS

$I_{F(AV)}$	2 x 30 A
V_{RRM}	1000 V
$V_F(max)$	1.8 V
$t_{rr}(max)$	80 ns

FEATURES AND BENEFITS

- VERY LOW REVERSE RECOVERY TIME
- VERY LOW SWITCHING LOSSES
- LOW NOISE TURN-OFF SWITCHING
- INSULATED PACKAGE: ISOTOP
Insulation voltage: 2500 V_{RMS}
Capacitance = 45 pF
Inductance < 5 nH

DESCRIPTION

Dual high voltage rectifier devices are suited for free-wheeling function in converters and motor control circuits.

Packaged in ISOTOP, they are intended for use in Switch Mode Power Supplies.

ABSOLUTE RATINGS (limiting values, per diode)

Symbol	Parameter		Value	Unit
V_{RRM}	Repetitive peak reverse voltage		1000	V
I_{FRM}	Repetitive peak forward current	$t_p = 5 \mu s$ $F = 1 kHz$	700	A
$I_{F(RMS)}$	RMS forward current		50	A
$I_{F(AV)}$	Average forward current	$T_c = 55^\circ C$ $\delta = 0.5$	30	A
I_{FSM}	Surge non repetitive forward current	$t_p = 10 ms$ Sinusoidal	200	A
T_{stg}	Storage temperature range		- 40 to + 150	°C
T_j	Maximum operating junction temperature		150	°C

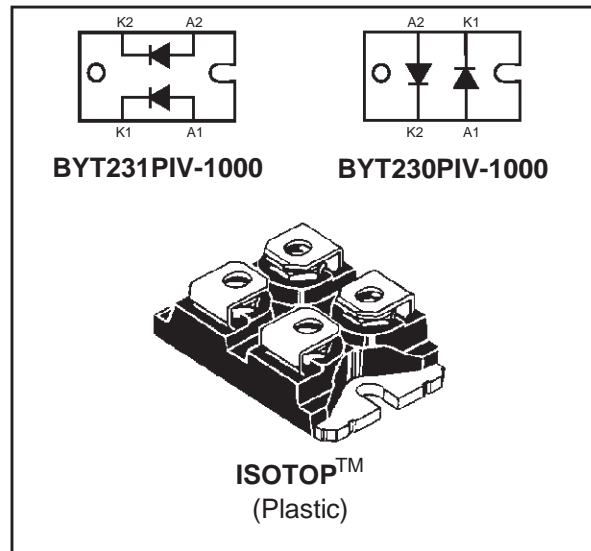

TM: ISOTOP is a registered trademark of STMicroelectronics.

BYT230PIV-1000 / BYT231PIV-1000

THERMAL RESISTANCES

Symbol	Parameter		Value	Unit
R _{th(j-c)}	Junction to case	Per diode	1.5	°C/W
		Total	0.8	
R _{th(c)}		Coupling	0.1	

When the diodes 1 and 2 are used simultaneously :

$$\Delta T_j(\text{diode 1}) = P(\text{diode}) \times R_{th(j-c)} (\text{Per diode}) + P(\text{diode 2}) \times R_{th(c)}$$

STATIC ELECTRICAL CHARACTERISTICS (per diode)

Symbol	Parameter	Test Conditions		Min.	Typ.	Max.	Unit
V _F *	Forward voltage drop	T _j = 25°C	I _F = 30 A			1.9	V
		T _j = 100°C				1.8	
I _R **	Reverse leakage current	T _j = 25°C	V _R = V _{RRM}			100	μA
		T _j = 100°C				5	mA

Pulse test : * t_p = 380 μs, δ < 2%

** t_p = 5 ms, δ < 2%

To evaluate the conduction losses use the following equation:

$$P = 1.47 \times I_{F(AV)} + 0.010 I_{F(RMS)}^2$$

RECOVERY CHARACTERISTICS (per diode)

Symbol	Test Conditions		Min.	Typ.	Max.	Unit
t _{rr}	T _j = 25°C	I _F = 1A V _R = 30V dI _F /dt = - 15A/μs			165	ns
		I _F = 0.5A I _R = 1A I _{rr} = 0.25A			80	

TURN-OFF SWITCHING CHARACTERISTICS (per diode)

Symbol	Parameter	Test Conditions		Min.	Typ.	Max.	Unit
t _{IRM}	Maximum reverse recovery time	dI _F /dt = - 120 A/μs	V _{CC} = 200 V I _F = 30 A L _p ≤ 0.05 μH T _j = 100°C (see fig. 11)			200	ns
		dI _F /dt = - 240 A/μs				120	
I _{RM}	Maximum reverse recovery current	dI _F /dt = - 120 A/μs	T _j = 100°C (see fig. 11)			19.5	A
		dI _F /dt = - 240 A/μs				22	
C = $\frac{V_{RP}}{V_{CC}}$	Turn-off overvoltage coefficient	T _j = 100°C V _{CC} = 200V I _F = I _{F(AV)} dI _F /dt = - 30A/μs L _p = 5μH (see fig. 12)				4.5	/

Fig. 1: Low frequency power losses versus average current.

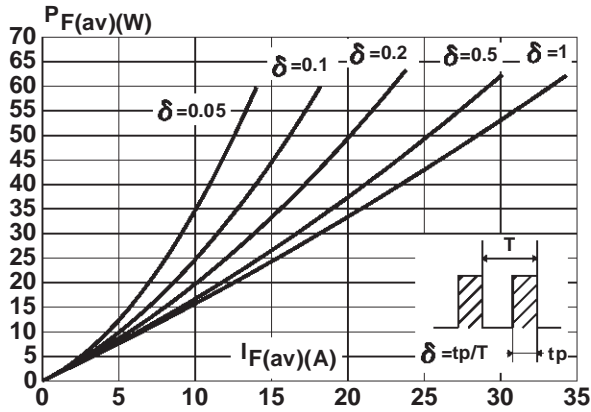

Fig. 2: Peak current versus form factor.

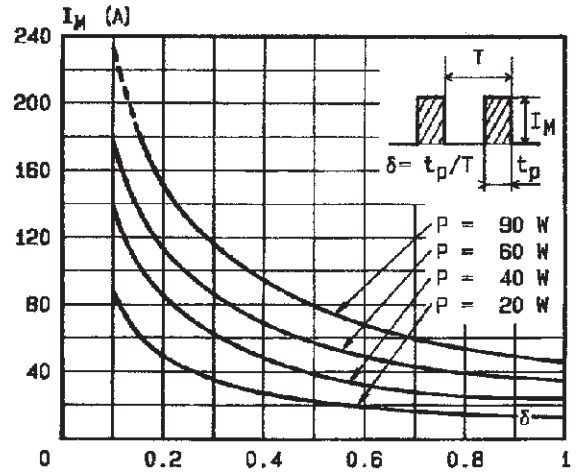

Fig. 3: Non repetitive peak surge current versus overload duration.

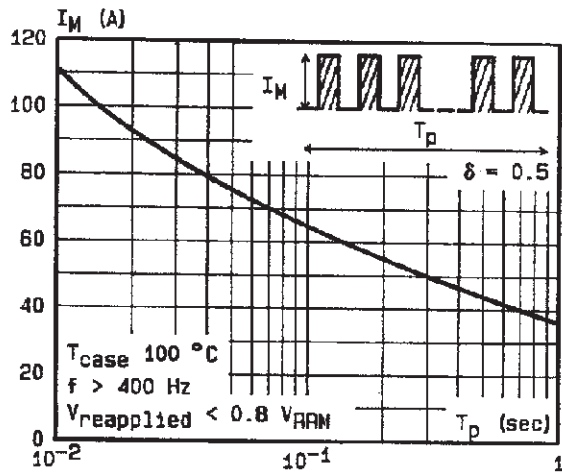

Fig. 4: Relative variation of thermal impedance junction to case versus pulse duration.

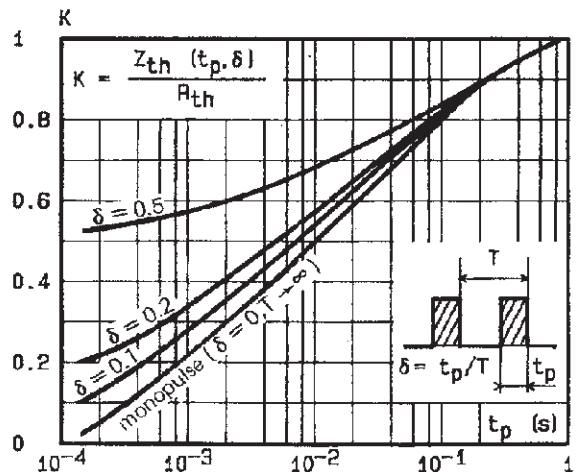

Fig. 5: Voltage drop versus forward current.

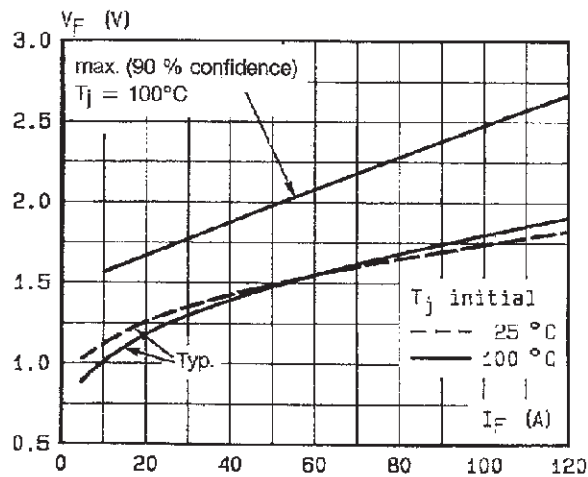

Fig. 6: Recovery charge versus diF/dt.

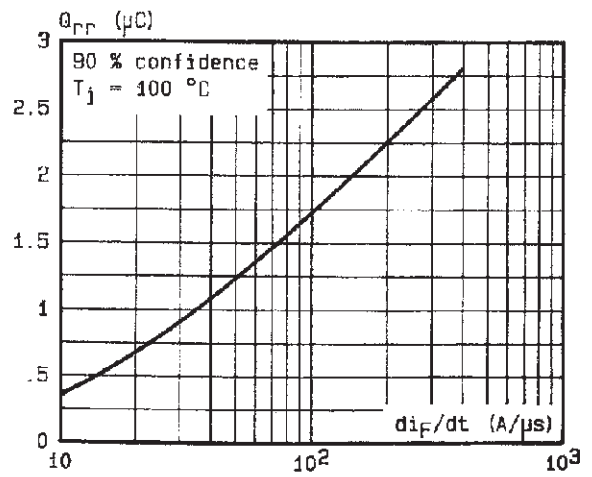

Fig. 7: Recovery time versus di_F/dt .

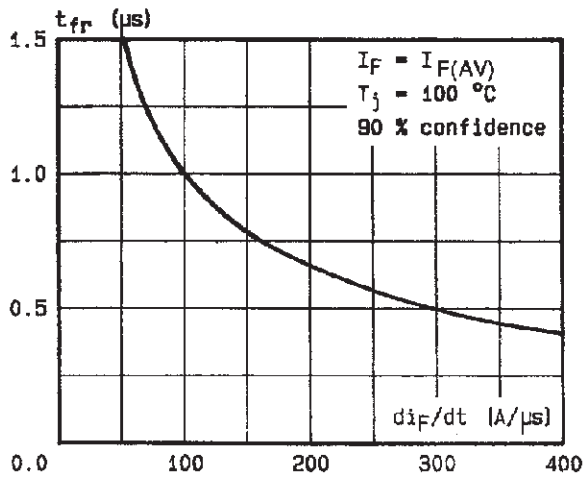

Fig. 9: Peak forward voltage versus di_F/dt .

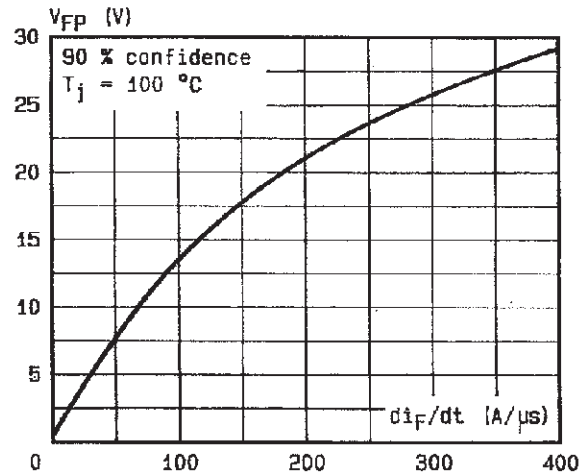

Fig. 11: Turn-off switching characteristics (without serie inductance).

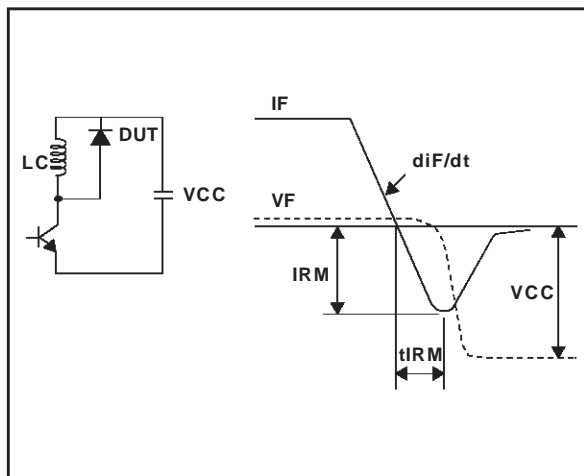

Fig. 8: Peak reverse current versus di_F/dt .

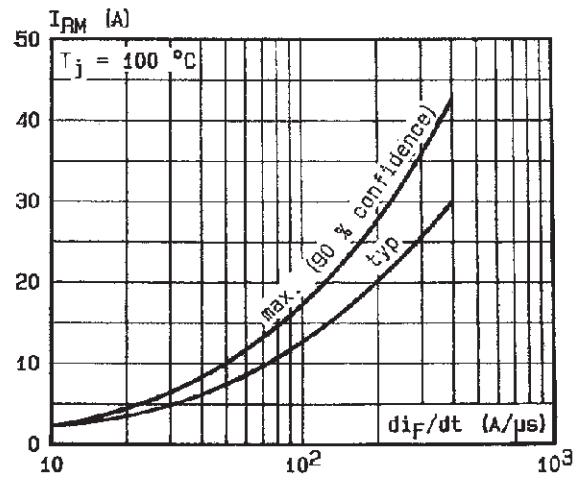

Fig. 10: Dynamic parameters versus junction temperature.

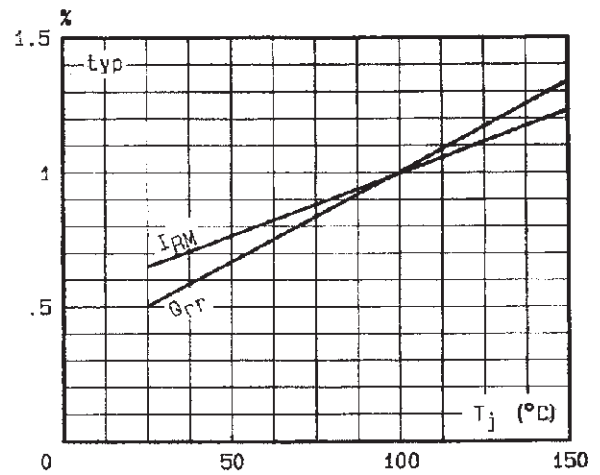
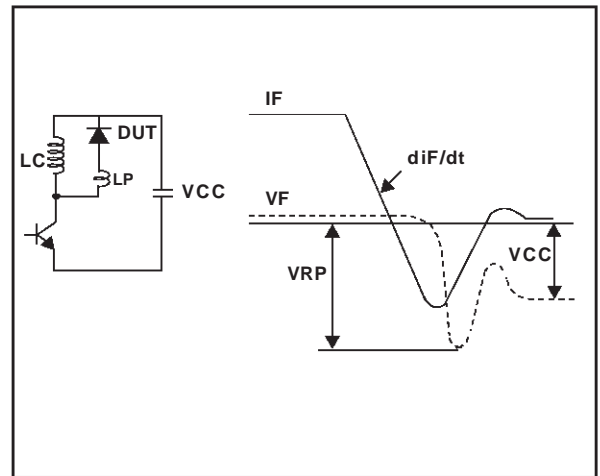
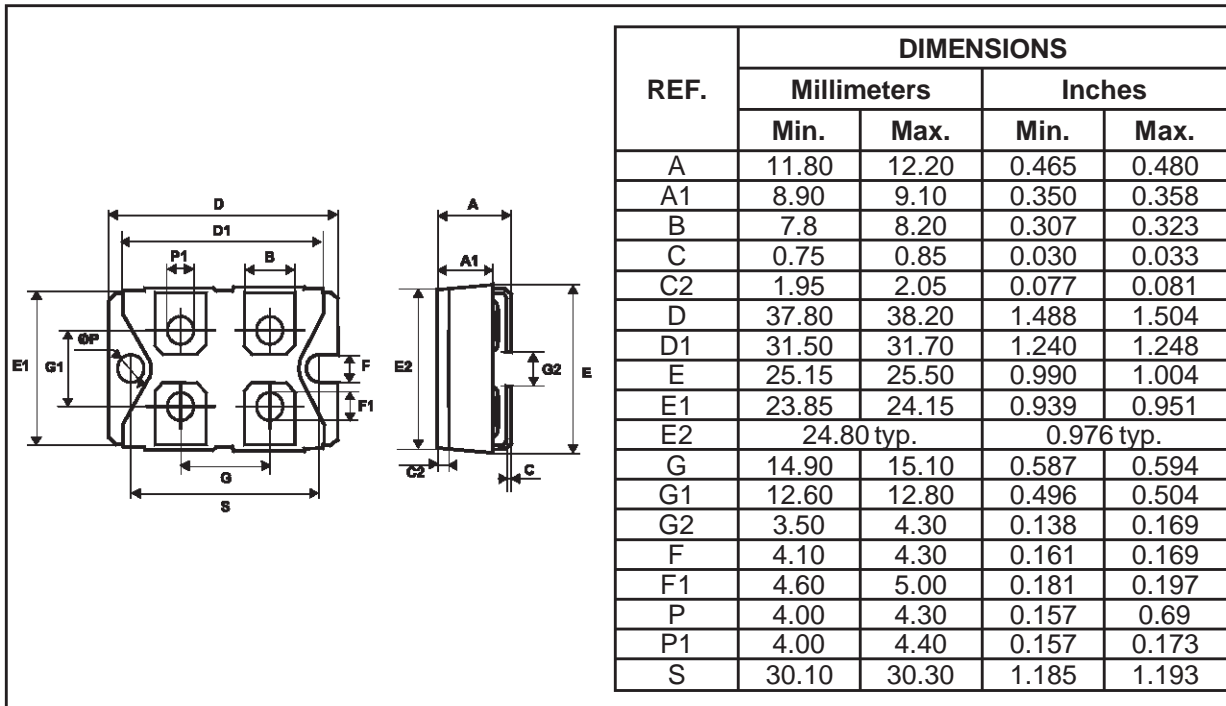

Fig. 12: Turn-off switching characteristics (with serie inductance).



PACKAGE MECHANICAL DATA
ISOTOP



Ordering type	Marking	Package	Weight	Base qty	Delivery mode
BYT230PIV-1000	BYT230PIV-1000	ISOTOP	28 g. (without screws)	10	Tube
BYT231PIV-1000	BYT231PIV-1000	ISOTOP	28 g. (without screws)	10	Tube

- Cooling method: by conduction (C)
- Recommended torque value : 1.3 N.m (MAX 1.5 N.m) for the 6 x M4 screws. (2 x M4 screws recommended for mounting the package on the heatsink and the 4 screws given with the screw version). The screws supplied with the package are adapted for mounting on a board (or other types of terminals) with a thickness of 0.6 mm min and 2.2 mm max.
- Epoxy meets UL94,V0

Information furnished is believed to be accurate and reliable. However, STMicroelectronics assumes no responsibility for the consequences of use of such information nor for any infringement of patents or other rights of third parties which may result from its use. No license is granted by implication or otherwise under any patent or patent rights of STMicroelectronics. Specifications mentioned in this publication are subject to change without notice. This publication supersedes and replaces all information previously supplied. STMicroelectronics products are not authorized for use as critical components in life support devices or systems without express written approval of STMicroelectronics.

The ST logo is a registered trademark of STMicroelectronics

© 1999 STMicroelectronics - Printed in Italy - All rights reserved.

STMicroelectronics GROUP OF COMPANIES

Australia - Brazil - China - Finland - France - Germany - Hong Kong - India - Italy - Japan - Malaysia
Malta - Morocco - Singapore - Spain - Sweden - Switzerland - United Kingdom - U.S.A.

<http://www.st.com>





LittleDiode supplies new, hard to find or obsolete electronic components and semiconductors all over the world.

With over two million different components listed you are sure to find the part you need.

Feel free to visit us today at our online store:

LittleDiode.com

Looking forward to providing you with the best possible service.