

DATA SHEET

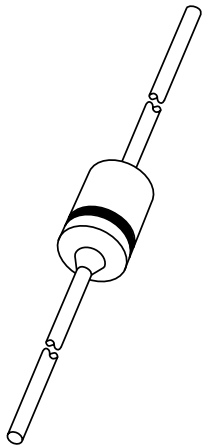

BYD73 series Ultra fast low-loss controlled avalanche rectifiers

Product specification
Supersedes data of 1996 May 24

1996 Sep 18

Ultra fast low-loss controlled avalanche rectifiers

BYD73 series

FEATURES

- Glass passivated
- High maximum operating temperature
- Low leakage current
- Excellent stability
- Guaranteed avalanche energy absorption capability
- Available in ammo-pack.

DESCRIPTION

Cavity free cylindrical glass SOD81 package through Implotec™⁽¹⁾ technology. This package is

hermetically sealed and fatigue free as coefficients of expansion of all used parts are matched.

(1) Implotec is a trademark of Philips.

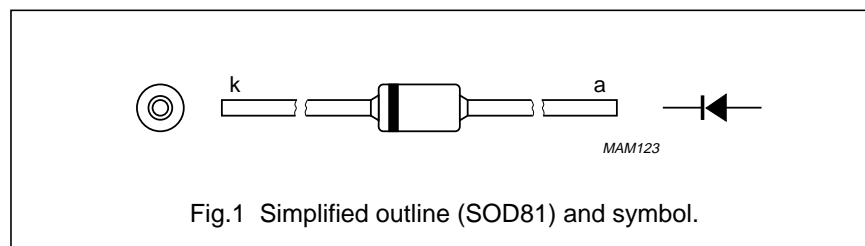

LIMITING VALUES

In accordance with the Absolute Maximum Rating System (IEC 134).

SYMBOL	PARAMETER	CONDITIONS	MIN.	MAX.	UNIT
V _{RRM}	repetitive peak reverse voltage				
	BYD73A		–	50	V
	BYD73B		–	100	V
	BYD73C		–	150	V
	BYD73D		–	200	V
	BYD73E		–	250	V
	BYD73F		–	300	V
	BYD73G		–	400	V
V _R	continuous reverse voltage				
	BYD73A		–	50	V
	BYD73B		–	100	V
	BYD73C		–	150	V
	BYD73D		–	200	V
	BYD73E		–	250	V
	BYD73F		–	300	V
	BYD73G		–	400	V
I _{F(AV)}	average forward current	T _{tp} = 55 °C; lead length = 10 mm; see Figs 2 and 3;	–	1.75	A
	BYD73A to D	averaged over any 20 ms period; see also Figs 10 and 11	–	1.70	A
I _{F(AV)}	average forward current	T _{amb} = 60 °C; PCB mounting (see Fig.16); see Figs 4 and 5;	–	1.00	A
	BYD73A to D	averaged over any 20 ms period; see also Figs 10 and 11	–	0.95	A
	BYD73E to G				

Ultra fast low-loss controlled avalanche rectifiers

BYD73 series

SYMBOL	PARAMETER	CONDITIONS	MIN.	MAX.	UNIT
I_{FRM}	repetitive peak forward current	$T_{tp} = 55\text{ °C}$; see Figs 6 and 7	–	14	A
	BYD73A to D			15	A
I_{FRM}	repetitive peak forward current	$T_{amb} = 60\text{ °C}$; see Figs 8 and 9	–	8.5	A
	BYD73E to G			9.5	A
I_{FSM}	non-repetitive peak forward current	$t = 10\text{ ms}$ half sine wave; $T_j = T_{j\text{ max}}$ prior to surge; $V_R = V_{RRM\text{ max}}$	–	25	A
E_{RSM}	non-repetitive peak reverse avalanche energy	$L = 120\text{ mH}$; $T_j = T_{j\text{ max}}$ prior to surge; inductive load switched off	–	10	mJ
T_{stg}	storage temperature		–65	+175	°C
T_j	junction temperature		–65	+175	°C

ELECTRICAL CHARACTERISTICS

$T_j = 25\text{ °C}$ unless otherwise specified.

SYMBOL	PARAMETER	CONDITIONS	MIN.	TYP.	MAX.	UNIT			
V_F	forward voltage	$I_F = 1\text{ A}$; $T_j = T_{j\text{ max}}$; see Figs 12 and 13	–	–	0.75	V			
	BYD73A to D				0.83	V			
V_F	forward voltage	$I_F = 1\text{ A}$; see Figs 12 and 13	–	–	0.98	V			
	BYD73E to G				1.05	V			
$V_{(BR)R}$	reverse avalanche breakdown voltage	$I_R = 0.1\text{ mA}$							
	BYD73A					55	–	–	V
	BYD73B					110	–	–	V
	BYD73C					165	–	–	V
	BYD73D					220	–	–	V
	BYD73E					275	–	–	V
	BYD73F					330	–	–	V
	BYD73G					440	–	–	V
I_R	reverse current	$V_R = V_{RRM\text{ max}}$; see Fig.14	–	–	1	μA			
		$V_R = V_{RRM\text{ max}}$; $T_j = 165\text{ °C}$; see Fig.14	–	–	100	μA			
t_{rr}	reverse recovery time	when switched from $I_F = 0.5\text{ A}$ to $I_R = 1\text{ A}$; measured at $I_R = 0.25\text{ A}$; see Fig.18	–	–	25	ns			
	BYD73A to D				50	ns			
	BYD73E to G								

Ultra fast low-loss controlled avalanche rectifiers

BYD73 series

SYMBOL	PARAMETER	CONDITIONS	MIN.	TYP.	MAX.	UNIT
C _d	diode capacitance	f = 1 MHz; V _R = 0 V; see Fig.15	–	50	–	pF
	BYD73A to D					
	BYD73E to G		–	40	–	pF
$\left \frac{dI_R}{dt} \right $	maximum slope of reverse recovery current	when switched from I _F = 1 A to V _R ≥ 30 V and dI _F /dt = –1 A/μs; see Fig.17	–	–	4	A/μs
	BYD73A to D					
	BYD73E to G		–	–	5	A/μs

THERMAL CHARACTERISTICS

SYMBOL	PARAMETER	CONDITIONS	VALUE	UNIT
R _{th j-tp}	thermal resistance from junction to tie-point	lead length = 10 mm	60	K/W
R _{th j-a}	thermal resistance from junction to ambient	note 1	120	K/W

Note

1. Device mounted on an epoxy-glass printed-circuit board, 1.5 mm thick; thickness of Cu-layer ≥40 μm, see Fig.16. For more information please refer to the "General Part of associated Handbook".

Ultra fast low-loss
controlled avalanche rectifiers

BYD73 series

GRAPHICAL DATA

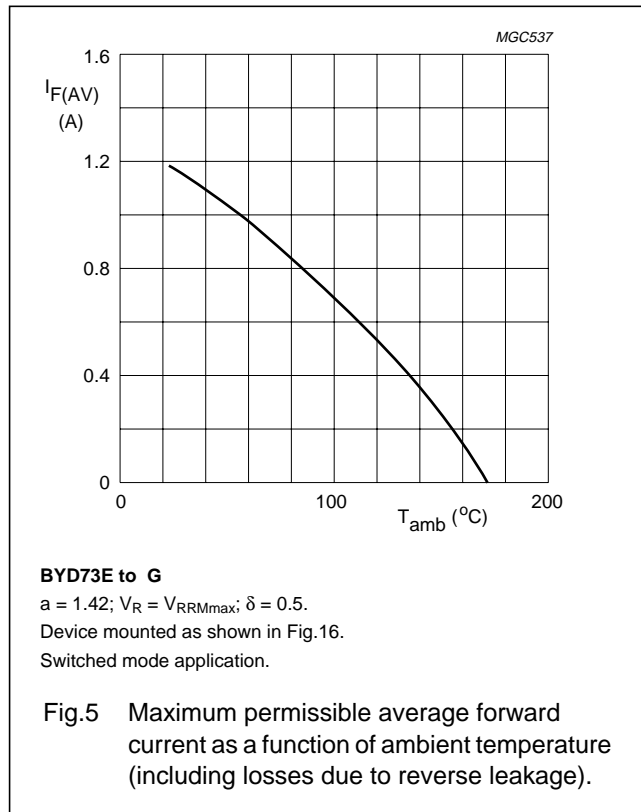
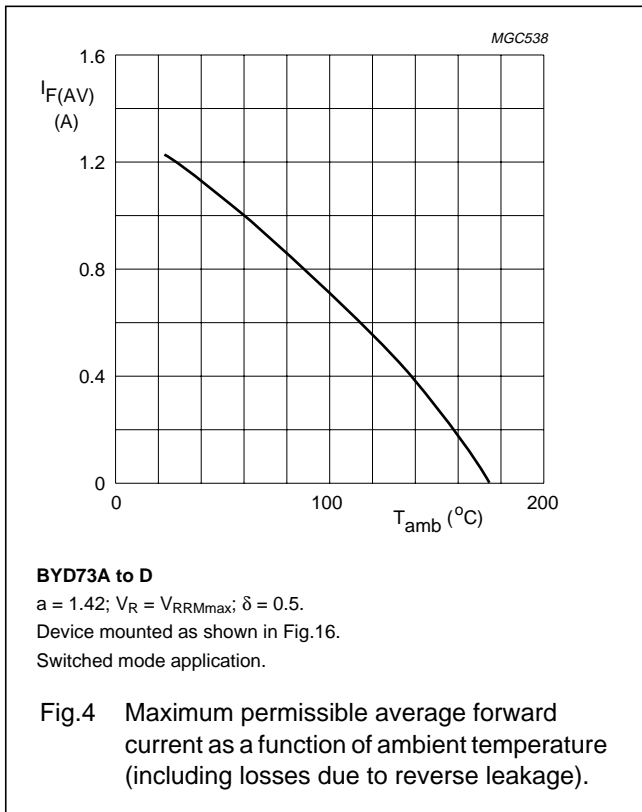
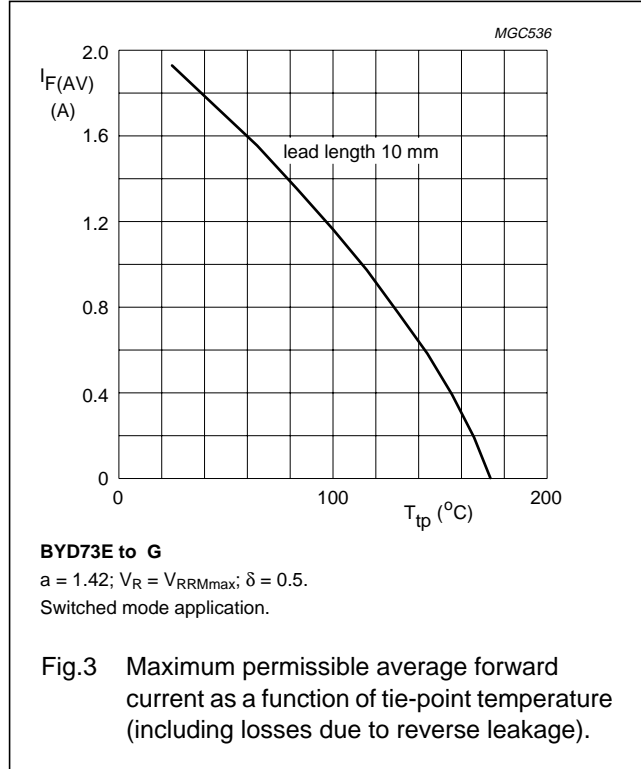
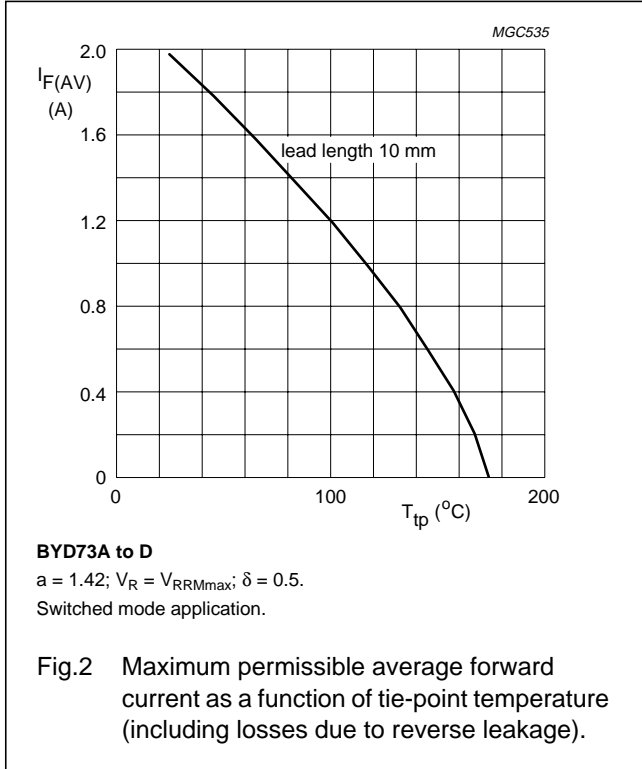

Ultra fast low-loss
controlled avalanche rectifiers

BYD73 series

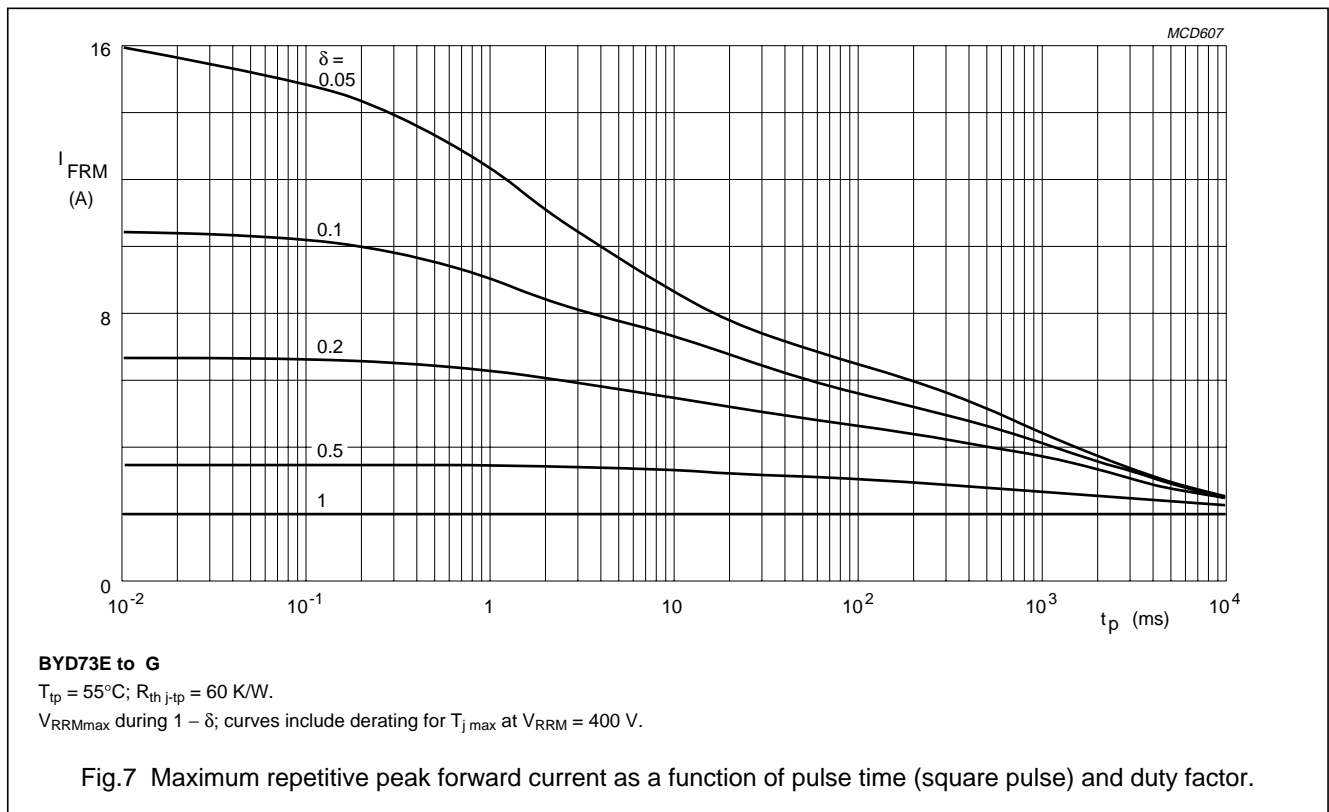
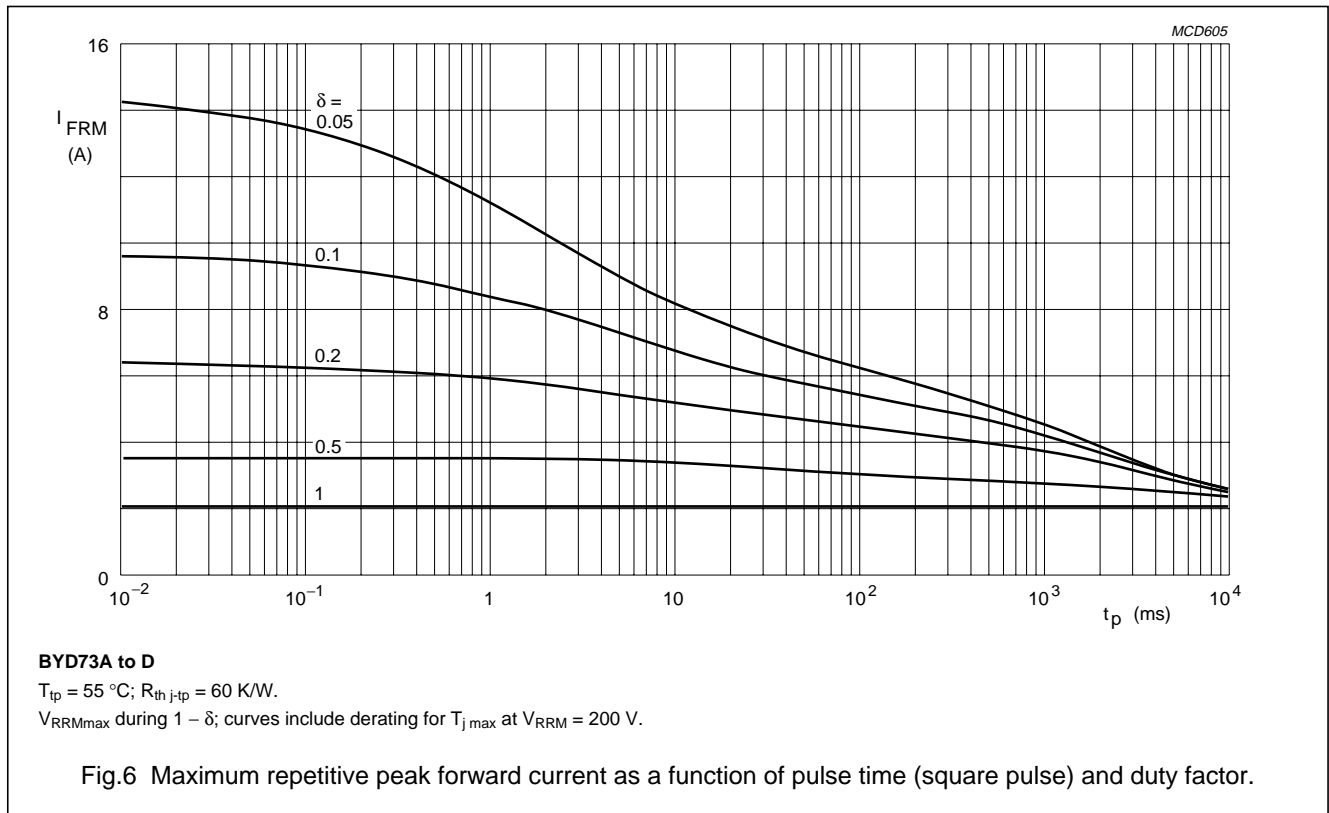

Ultra fast low-loss
controlled avalanche rectifiers

BYD73 series

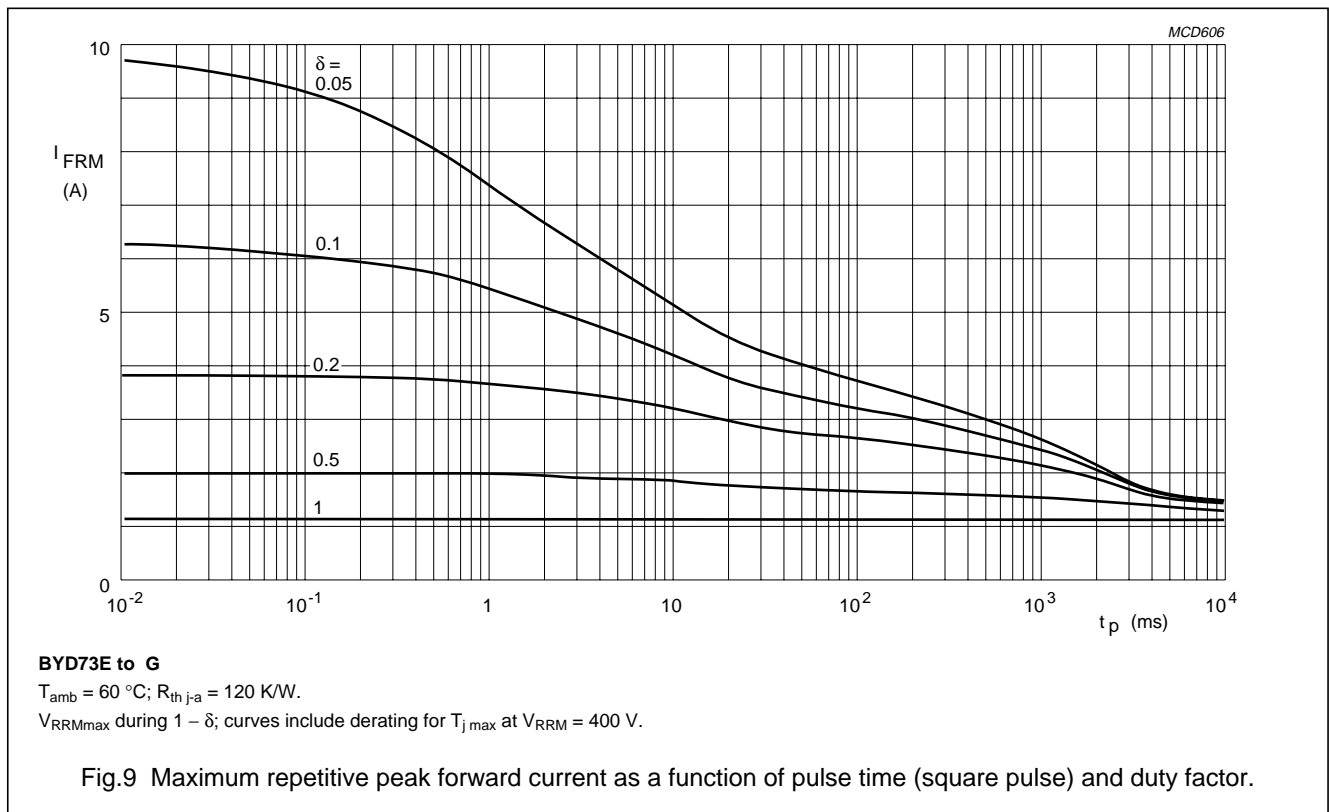
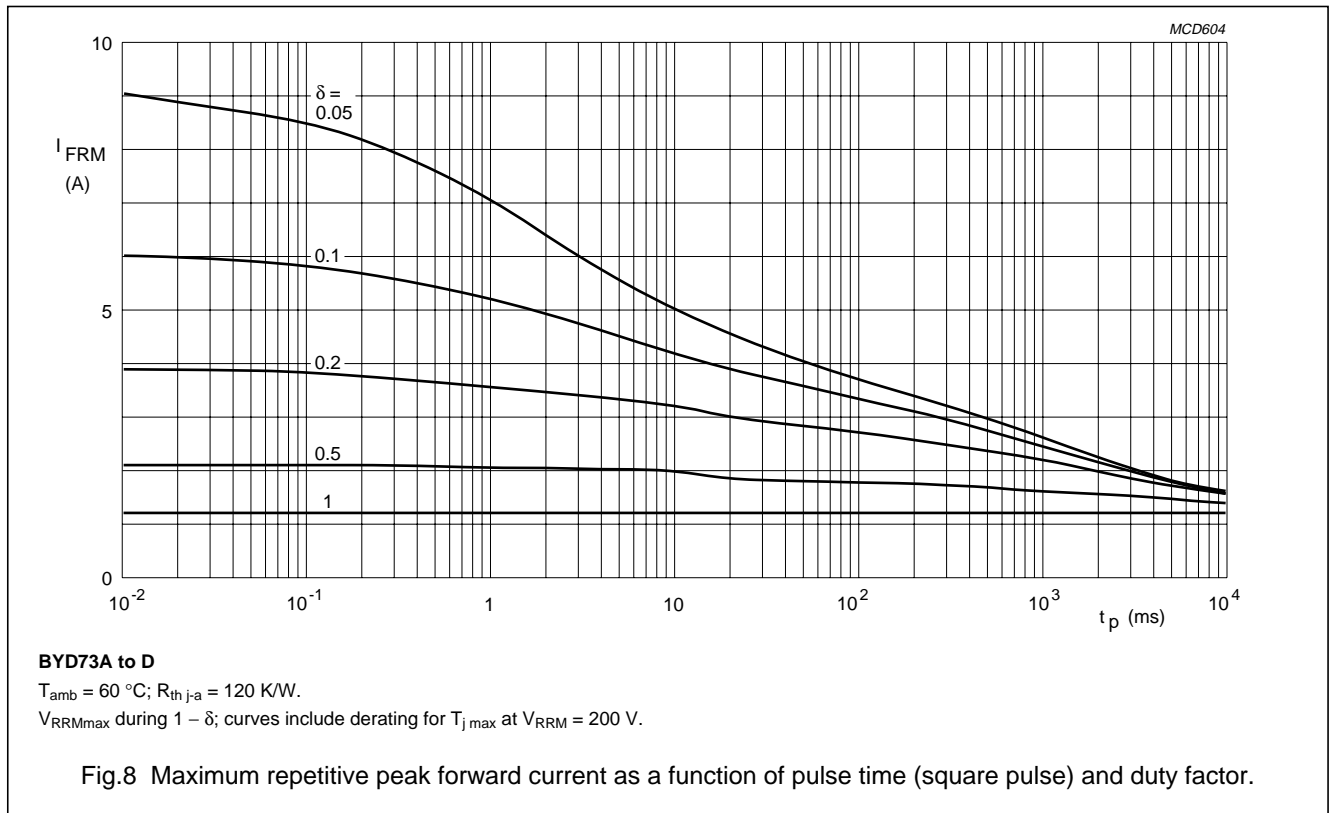

Ultra fast low-loss
controlled avalanche rectifiers

BYD73 series

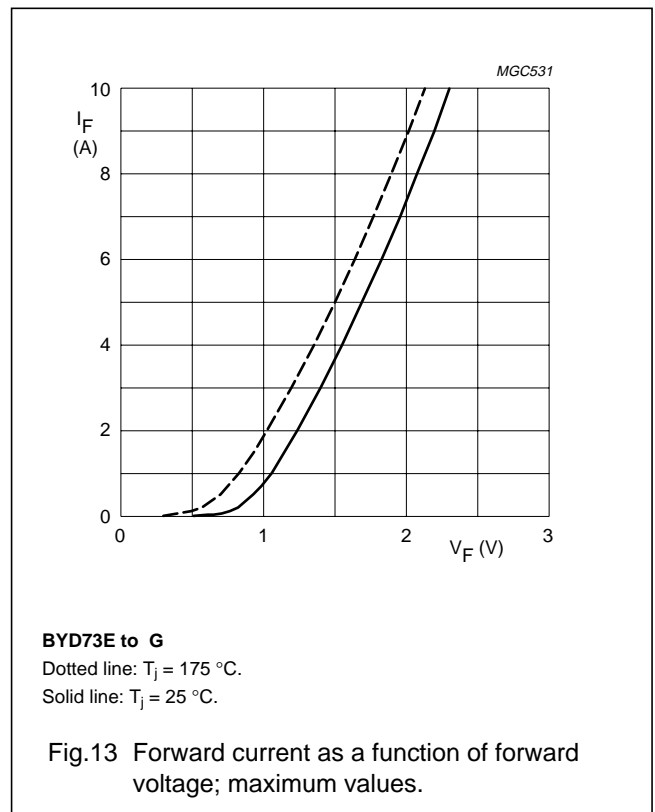
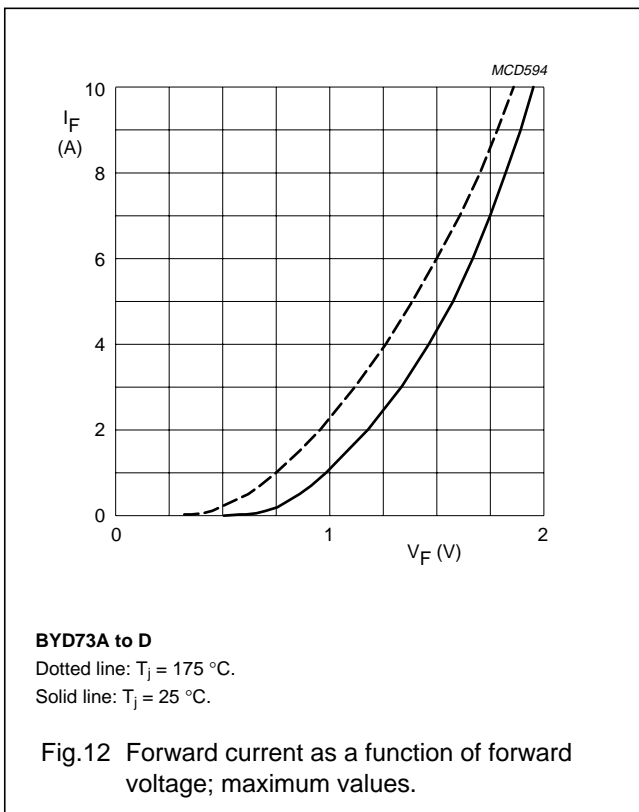
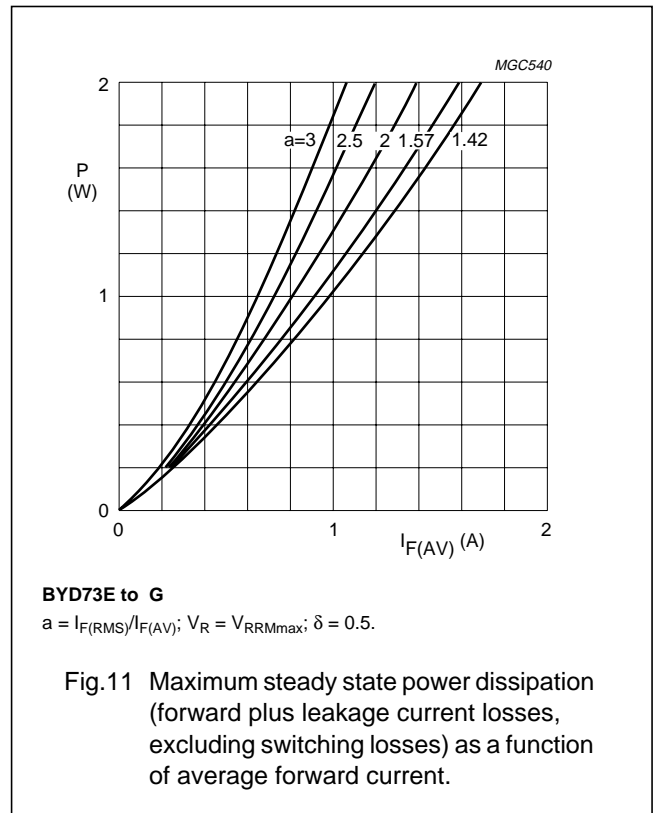
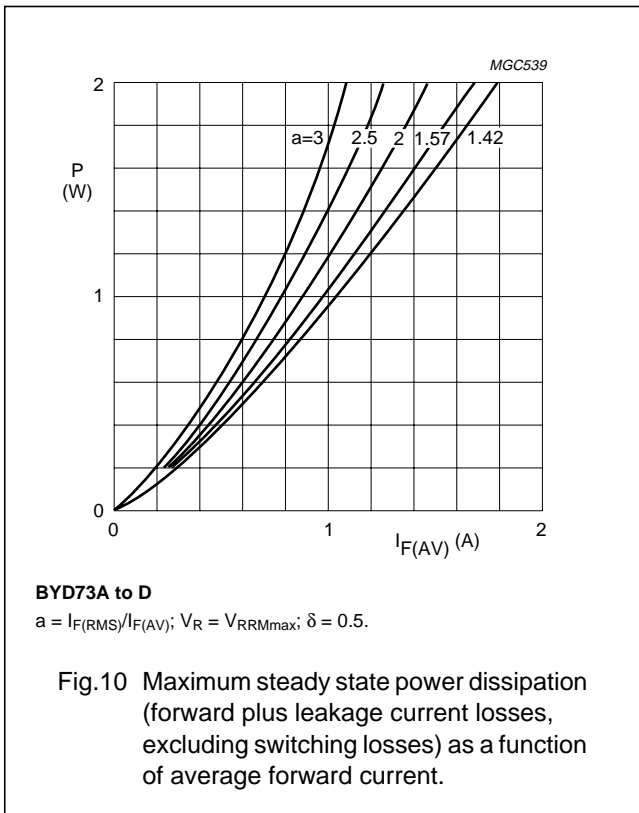

Ultra fast low-loss
controlled avalanche rectifiers

BYD73 series

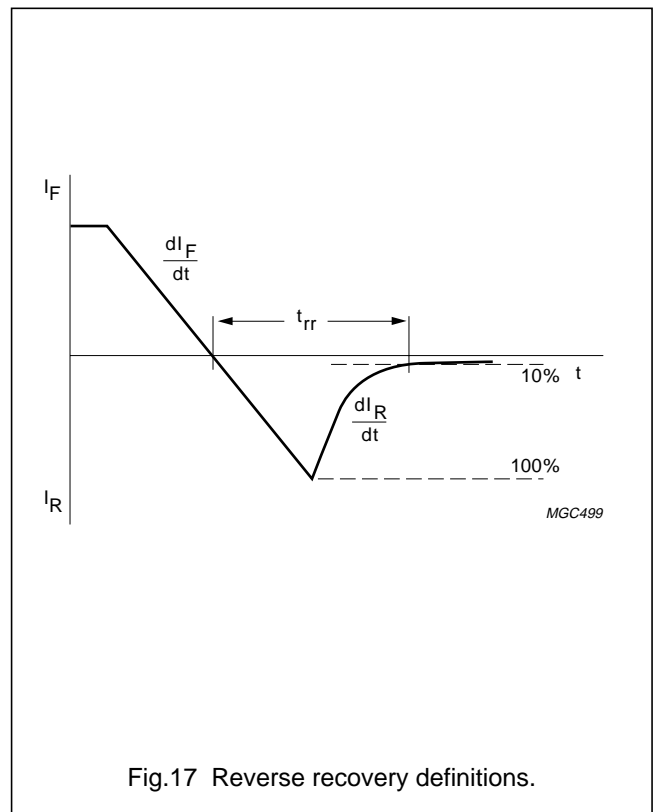
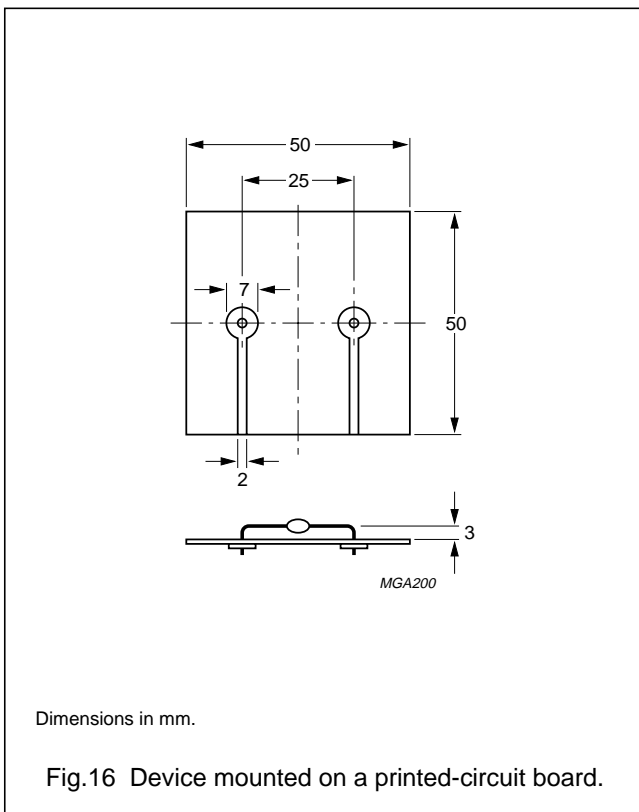
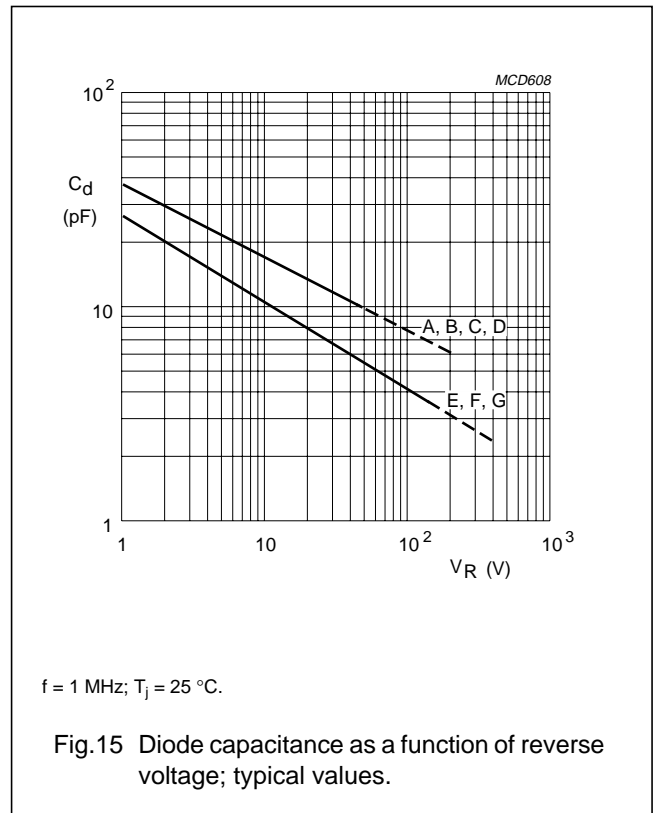
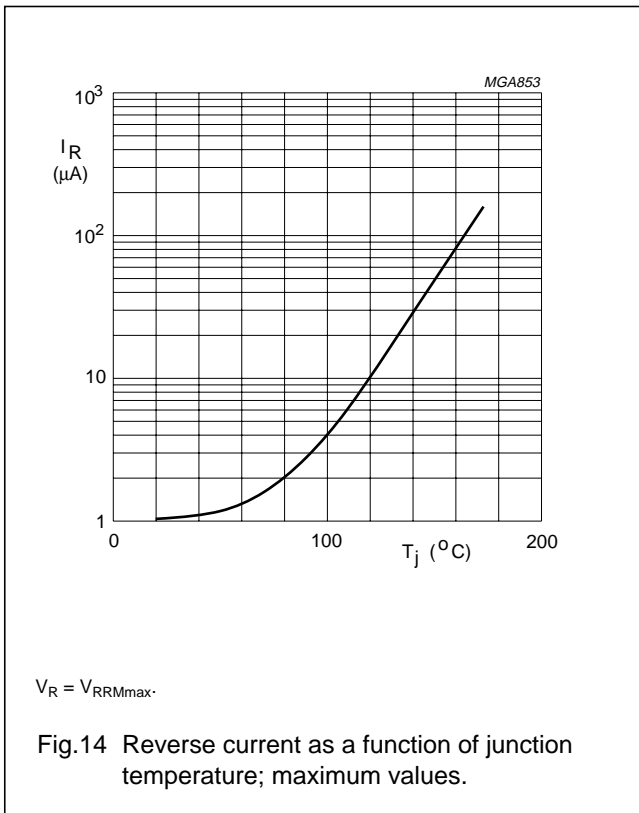

Ultra fast low-loss controlled avalanche rectifiers

BYD73 series

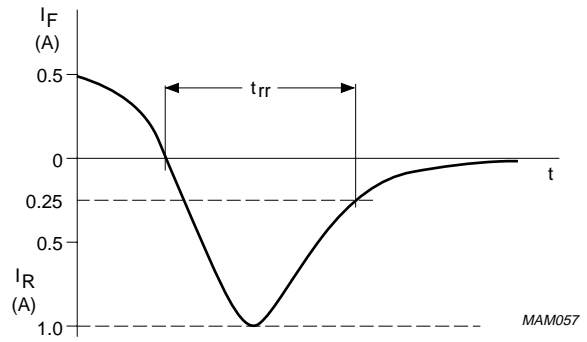
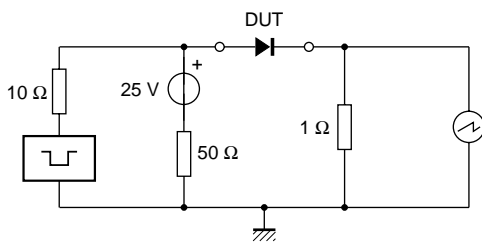

Input impedance oscilloscope: 1 MΩ, 22 pF; $t_r \leq 7$ ns.
Source impedance: 50 Ω; $t_r \leq 15$ ns.

Fig.18 Test circuit and reverse recovery time waveform and definition.

Ultra fast low-loss
controlled avalanche rectifiers

BYD73 series

PACKAGE OUTLINE

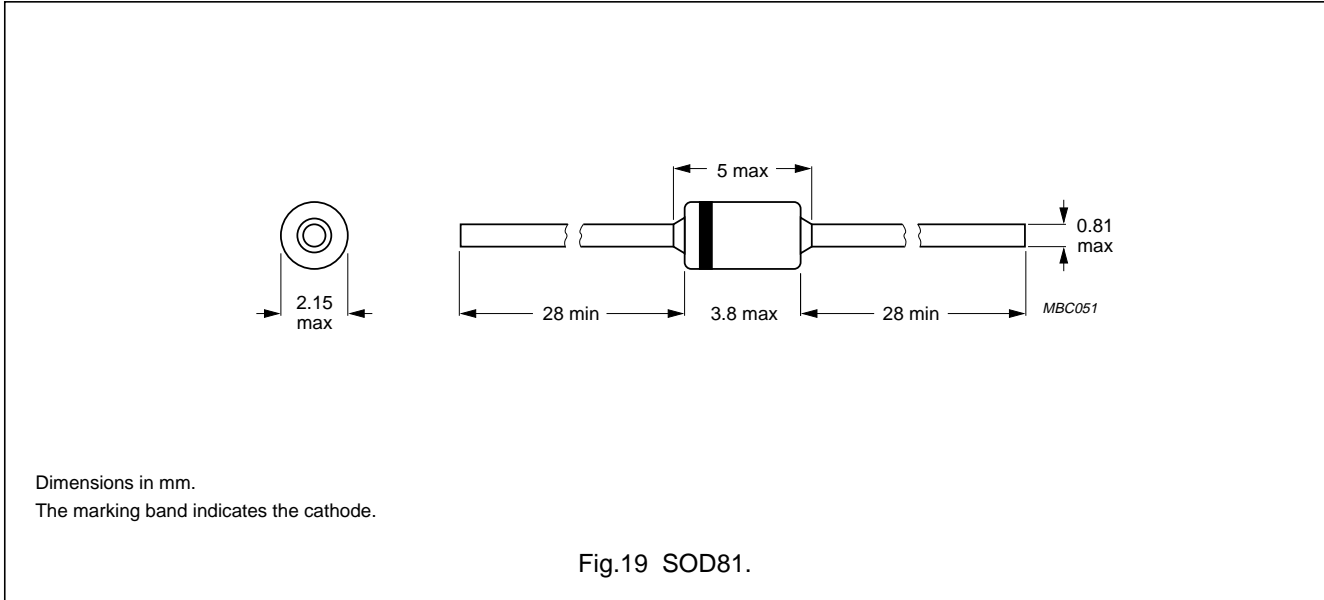

DEFINITIONS

Data Sheet Status	
Objective specification	This data sheet contains target or goal specifications for product development.
Preliminary specification	This data sheet contains preliminary data; supplementary data may be published later.
Product specification	This data sheet contains final product specifications.
Limiting values	
Limiting values given are in accordance with the Absolute Maximum Rating System (IEC 134). Stress above one or more of the limiting values may cause permanent damage to the device. These are stress ratings only and operation of the device at these or at any other conditions above those given in the Characteristics sections of the specification is not implied. Exposure to limiting values for extended periods may affect device reliability.	
Application information	
Where application information is given, it is advisory and does not form part of the specification.	

LIFE SUPPORT APPLICATIONS

These products are not designed for use in life support appliances, devices, or systems where malfunction of these products can reasonably be expected to result in personal injury. Philips customers using or selling these products for use in such applications do so at their own risk and agree to fully indemnify Philips for any damages resulting from such improper use or sale.



LittleDiode supplies new, hard to find or obsolete electronic components and semiconductors all over the world.

With over two million different components listed you are sure to find the part you need.

Feel free to visit us today at our online store:

LittleDiode.com

Looking forward to providing you with the best possible service.