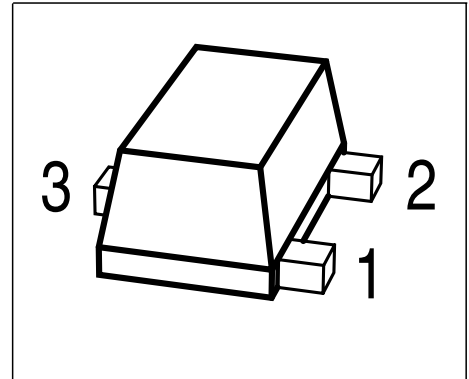

NPN Silicon RF Transistor

Preliminary data

- Low voltage/ low current operation
- For low noise amplifiers
- For Oscillators up to 3.5 GHz and Pout > 10 dBm
- Low noise figure: 1.0 dB at 1.8 GHz

ESD: Electrostatic discharge sensitive device, observe handling precaution!

Type	Marking	Pin Configuration			Package
BFR360F	FBs	1 = B	2 = E	3 = C	TSFP-3

Maximum Ratings

Parameter	Symbol	Value	Unit
Collector-emitter voltage	V_{CEO}	6	V
Collector-emitter voltage	V_{CES}	15	
Collector-base voltage	V_{CBO}	15	
Emitter-base voltage	V_{EBO}	2	
Collector current	I_C	35	mA
Base current	I_B	4	
Total power dissipation ¹⁾ $T_S \leq 98^\circ\text{C}$	P_{tot}	210	mW
Junction temperature	T_j	150	°C
Ambient temperature	T_A	-65 ... 150	
Storage temperature	T_{stg}	-65 ... 150	

Thermal Resistance

Parameter	Symbol	Value	Unit
Junction - soldering point ²⁾	R_{thJS}	≤ 250	K/W

¹⁾ T_S is measured on the collector lead at the soldering point to the pcb

²⁾For calculation of R_{thJA} please refer to Application Note Thermal Resistance

Electrical Characteristics at $T_A = 25^\circ\text{C}$, unless otherwise specified

Parameter	Symbol	Values			Unit
		min.	typ.	max.	
Characteristics					
Collector-emitter breakdown voltage $I_C = 1 \text{ mA}, I_B = 0$	$V_{(BR)CEO}$	6	9	-	V
Collector-emitter cutoff current $V_{CE} = 15 \text{ V}, V_{BE} = 0$	I_{CES}	-	-	10	μA
Collector-base cutoff current $V_{CB} = 5 \text{ V}, I_E = 0$	I_{CBO}	-	-	100	nA
Emitter-base cutoff current $V_{EB} = 1 \text{ V}, I_C = 0$	I_{EBO}	-	-	1	μA
DC current gain- $I_C = 15 \text{ mA}, V_{CE} = 3 \text{ V}$	h_{FE}	60	130	200	-

Electrical Characteristics at $T_A = 25^\circ\text{C}$, unless otherwise specified

Parameter	Symbol	Values			Unit
		min.	typ.	max.	
AC Characteristics (verified by random sampling)					
Transition frequency $I_C = 15\text{ mA}$, $V_{CE} = 3\text{ V}$, $f = 1\text{ GHz}$	f_T	11	14	-	GHz
Collector-base capacitance $V_{CB} = 5\text{ V}$, $f = 1\text{ MHz}$, emitter grounded	C_{cb}	-	0.32	0.5	pF
Collector emitter capacitance $V_{CE} = 5\text{ V}$, $f = 1\text{ MHz}$, base grounded	C_{ce}	-	0.2	-	
Emitter-base capacitance $V_{EB} = 0.5\text{ V}$, $f = 1\text{ MHz}$, collector grounded	C_{eb}	-	0.4	-	
Noise figure $I_C = 3\text{ mA}$, $V_{CE} = 3\text{ V}$, $Z_S = Z_{Sopt}$, $f = 1.8\text{ GHz}$	F_{min}	-	1	-	dB
Power gain, maximum available ¹⁾ $I_C = 15\text{ mA}$, $V_{CE} = 3\text{ V}$, $Z_S = Z_{Sopt}$, $Z_L = Z_{Lopt}$, $f = 1.8\text{ GHz}$	G_{ma}	-	15.5	-	
$I_C = 15\text{ mA}$, $V_{CE} = 3\text{ V}$, $Z_S = Z_{Sopt}$, $Z_L = Z_{Lopt}$, $f = 3\text{ GHz}$		-	11	-	
Transducer gain $I_C = 15\text{ mA}$, $V_{CE} = 3\text{ V}$, $Z_S = Z_L = 50\Omega$, $f = 1.8\text{ GHz}$	$ S_{21e} ^2$	-	13	-	dB
$I_C = 15\text{ mA}$, $V_{CE} = 3\text{ V}$, $Z_S = Z_L = 50\Omega$, $f = 3\text{ GHz}$		-	9	-	
Third order intercept point at output ²⁾ $V_{CE} = 3\text{ V}$, $I_C = 15\text{ mA}$, $f = 1.8\text{ GHz}$, $Z_S = Z_L = 50\Omega$	IP_3	-	24	-	dBm
1dB Compression point at output $I_C = 15\text{ mA}$, $V_{CE} = 3\text{ V}$, $Z_S = Z_L = 50\Omega$, $f = 1.8\text{ GHz}$	P_{-1dB}	-	9	-	

$$^1G_{ma} = |S_{21e}| / |S_{12e}| (k - (k^2 - 1)^{1/2})$$

²⁾IP3 value depends on termination of all intermodulation frequency components.
Termination used for this measurement is 50Ω from 0.1 MHz to 6 GHz

SPICE Parameter (Gummel-Poon Model, Berkley-SPICE 2G.6 Syntax):

Transistor Chip Data:

IS =	0.0689	fA	BF =	147	-	NF =	1	-
VAF =	20	V	IKF =	77.28	mA	ISE =	150	fA
NE =	2.4	-	BR =	6	-	NR =	1	-
VAR =	60	V	IKR =	0.3	A	ISC =	20	fA
NC =	1.4	-	RB =	0.1	Ω	IRB =	75	μ A
RBM =	7.31	Ω	RE =	78.2	m Ω	RC =	0.35	Ω
CJE =	400	fF	VJE =	1.3	V	MJE =	0.5	-
TF =	9.219	ps	XTF =	0.115	-	VTF =	0.198	V
ITF =	1.336	mA	PTF =	0	deg	CJC =	473	fF
VJC =	0.864	V	MJC =	0.486	-	XCJC =	0.129	-
TR =	1.92	ns	CJS =	0	fF	VJS =	0.75	V
MJS =	0	-	XTB =	0.5	K	EG =	1.11	eV
XTI =	0	-	FC =	0.954		NK =	0.5	K
AF =	1	-	KF =	1E-14	-			

All parameters are ready to use, no scaling is necessary.

Package Equivalent Circuit:

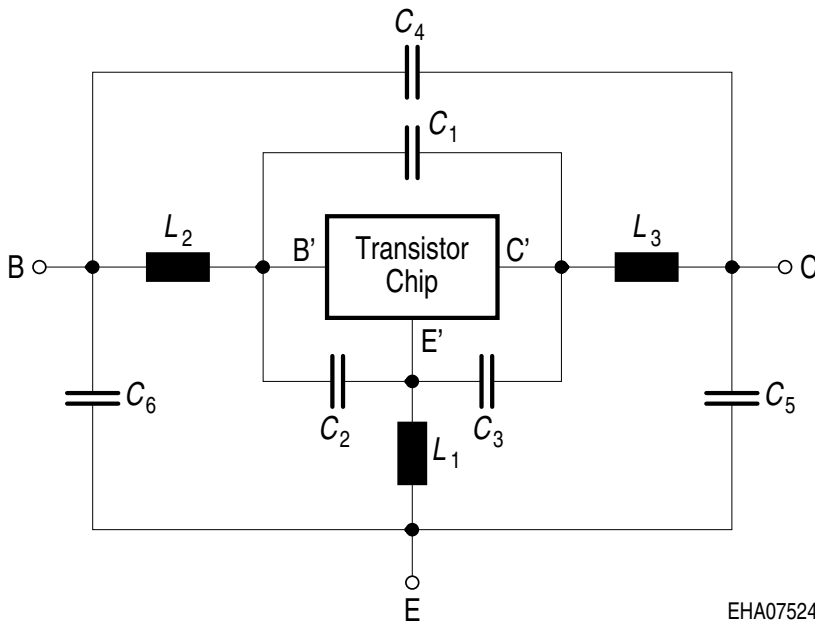

$L_1 =$	0.556	nH
$L_2 =$	0.657	nH
$L_3 =$	0.381	nH
$C_1 =$	43	fF
$C_2 =$	123	fF
$C_3 =$	66	fF
$C_4 =$	10	fF
$C_5 =$	36	fF
$C_6 =$	47	fF

Valid up to 6GHz

EHA07524

For examples and ready to use parameters please contact your local Infineon Technologies distributor or sales office to obtain a Infineon Technologies CD-ROM or see Internet: <http://www.infineon.com/silicondiscretres>

Total power dissipation $P_{tot} = f(T_S)$

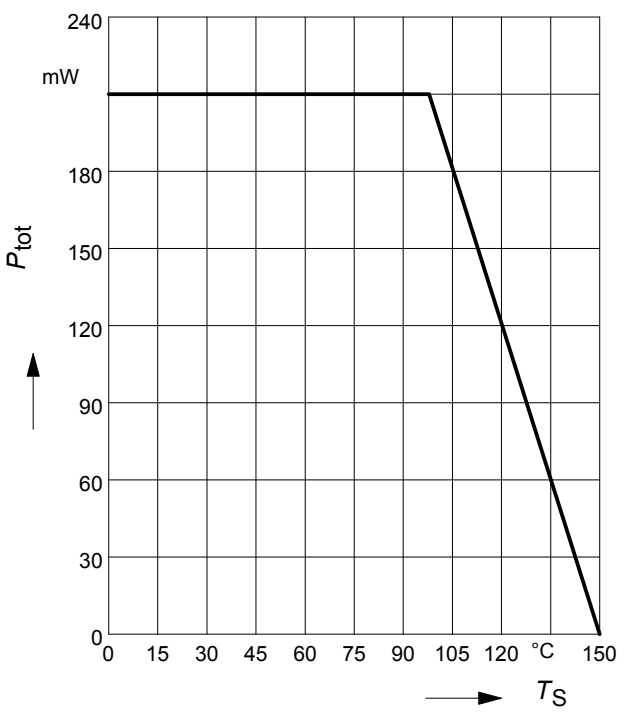

Permissible Pulse Load $R_{thJS} = f(t_p)$

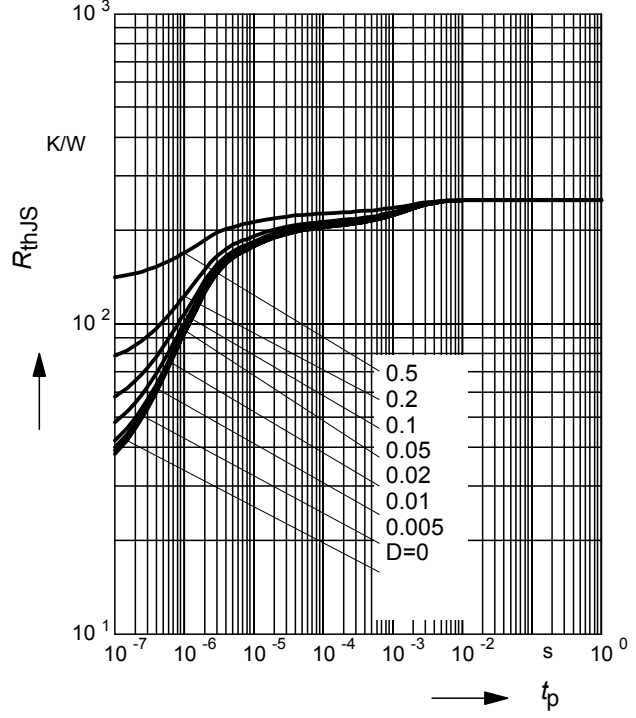

Permissible Pulse Load

$P_{totmax}/P_{totDC} = f(t_p)$

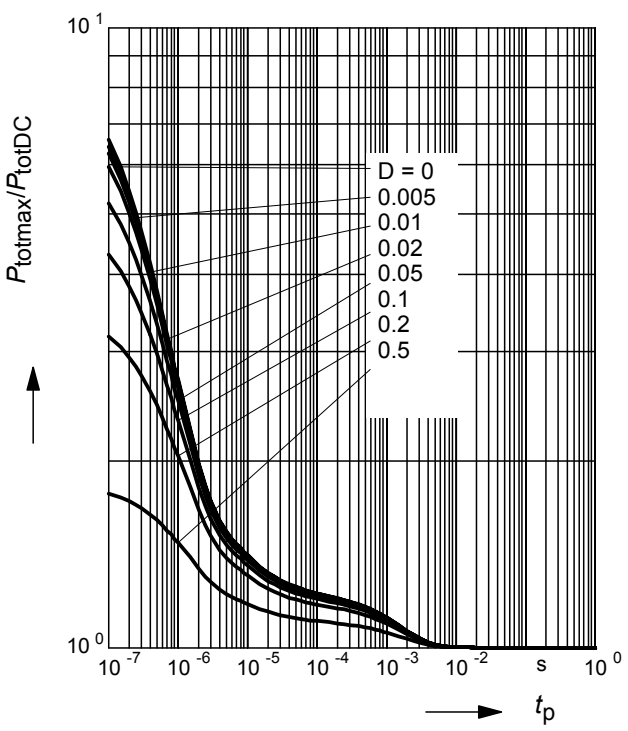

Collector-base capacitance $C_{cb} = f(V_{CB})$

$f = 1\text{MHz}$

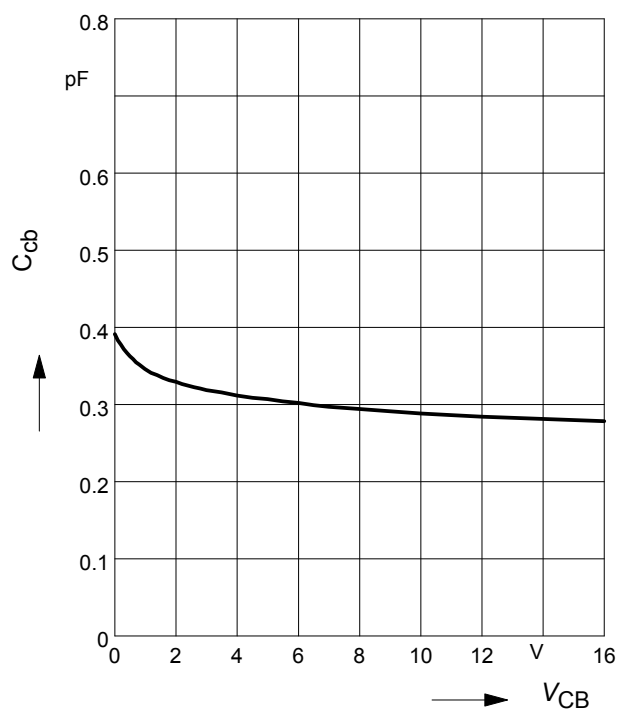

Third order Intercept Point $IP_3 = f(I_C)$

(Output, $Z_S = Z_L = 50\Omega$)

$V_{CE} = \text{parameter}$, $f = 1.8\text{GHz}$

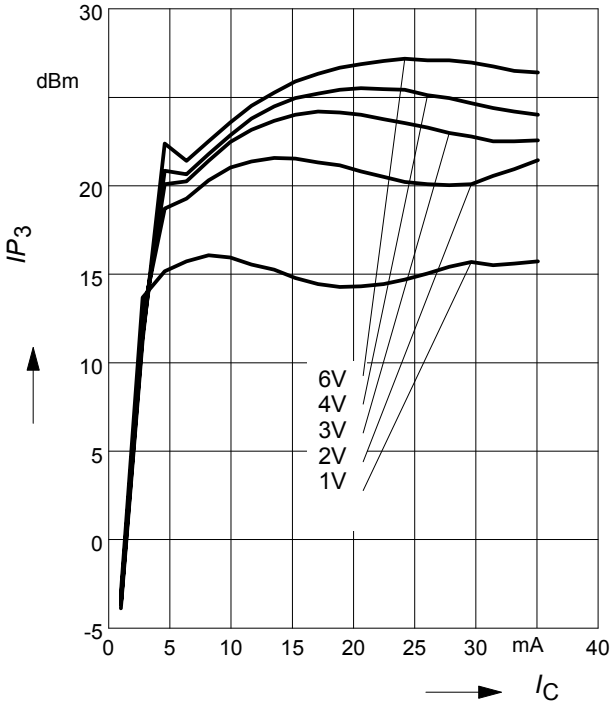

Transition frequency $f_T = f(I_C)$

$f = 1\text{GHz}$

$V_{CE} = \text{parameter}$

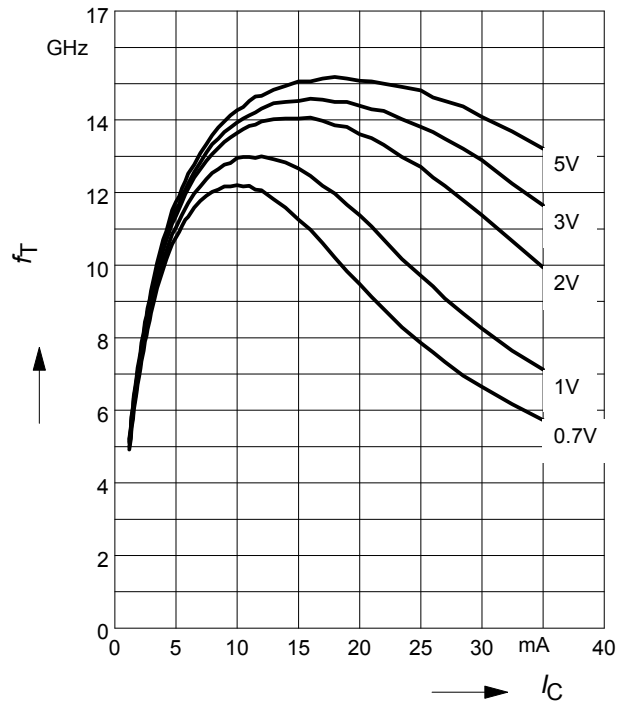

Power gain $G_{ma}, G_{ms} = f(I_C)$

$f = 0.9\text{GHz}$

$V_{CE} = \text{parameter}$

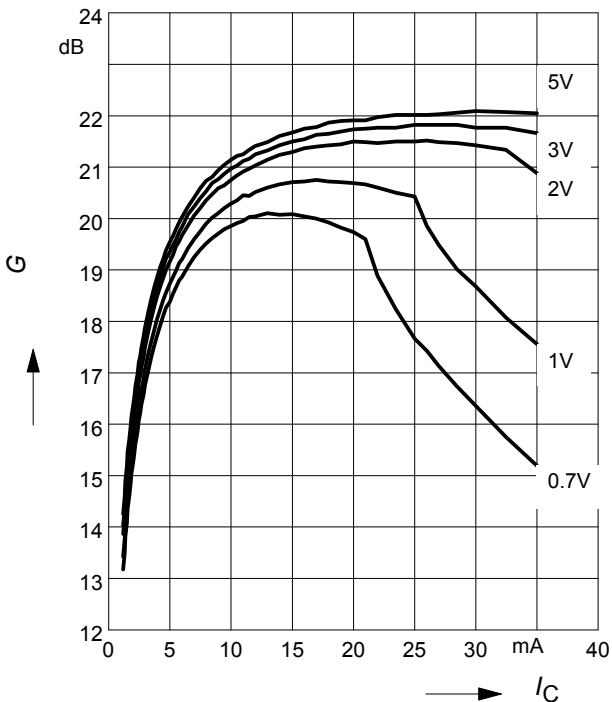

Power gain $G_{ma}, G_{ms} = f(I_C)$

$f = 1.8\text{GHz}$

$V_{CE} = \text{parameter}$

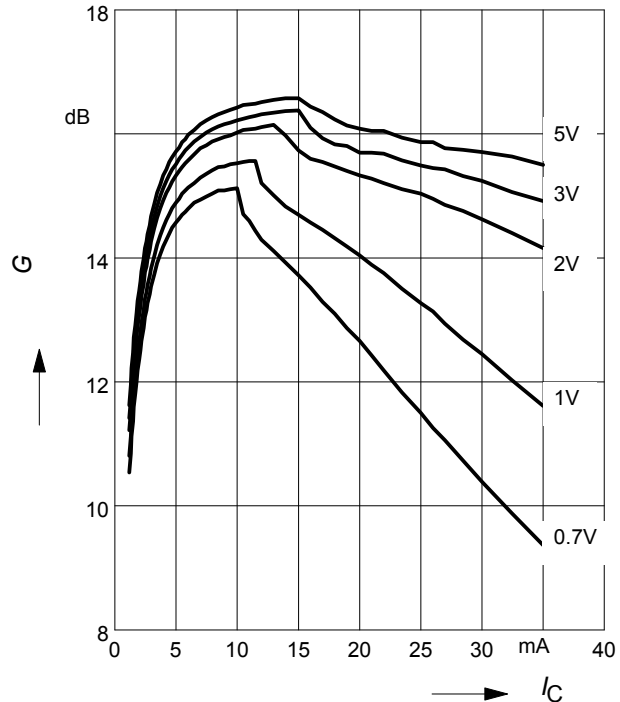

Power Gain G_{ma} , $G_{ms} = f(f)$

$V_{CE} = \text{parameter}$

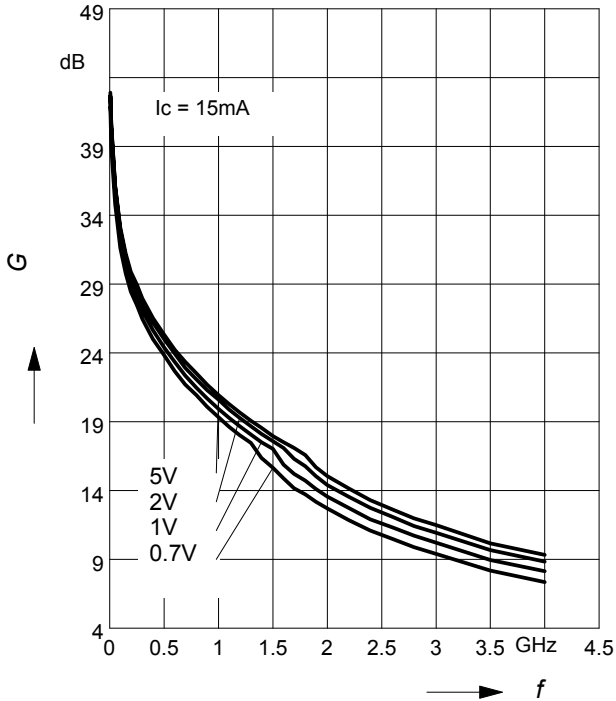

Insertion Power Gain $|S_{21}|^2 = f(f)$

$V_{CE} = \text{parameter}$

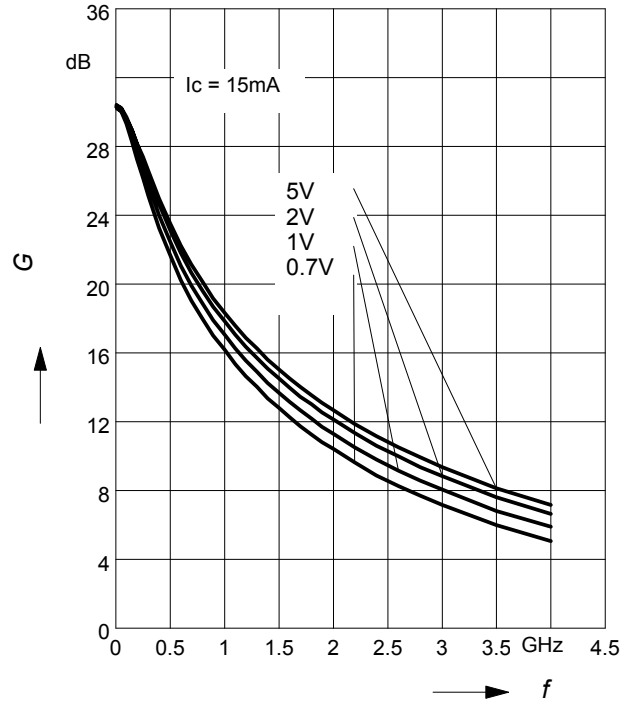

Power Gain G_{ma} , $G_{ms} = f(V_{CE})$: —

$|S_{21}|^2 = f(V_{CE})$: - - - -

$f = \text{parameter}$

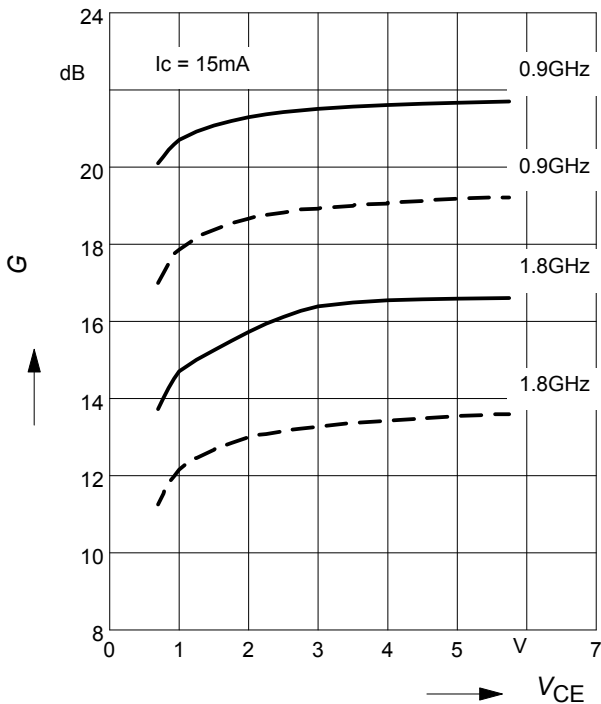

Power gain G_{ma} , $G_{ms} = f(I_C)$

$V_{CE} = 3V$

$f = \text{parameter}$

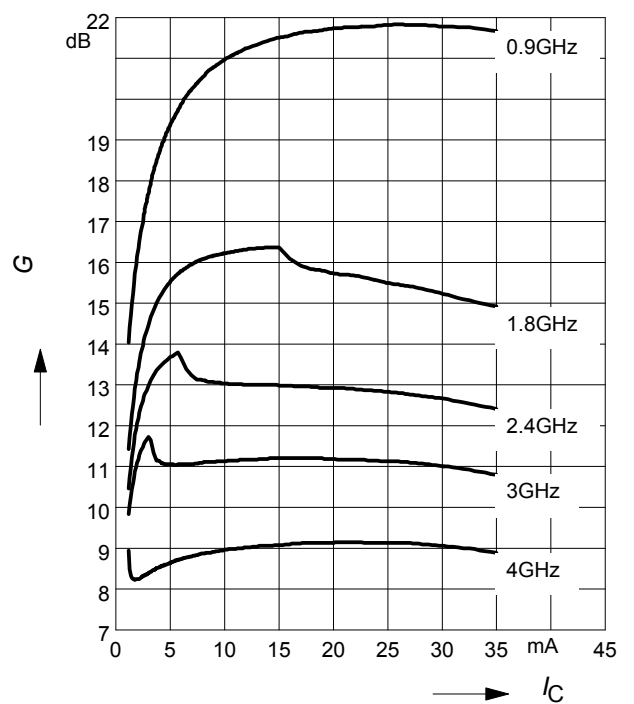

Noise figure $NF = f(I_C)$

$V_{CE} = 3V, f = 1,8 \text{ GHz}$

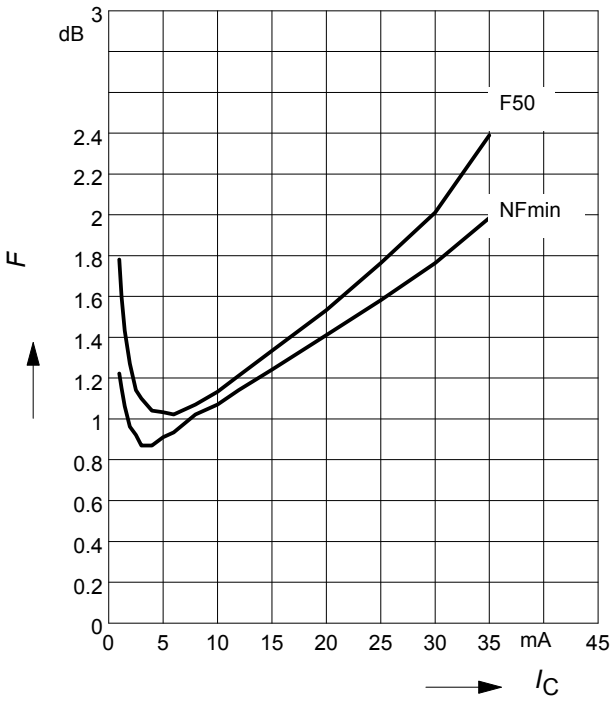

Source impedance for min.

noise figure vs. frequency

$V_{CE} = 3 \text{ V}$

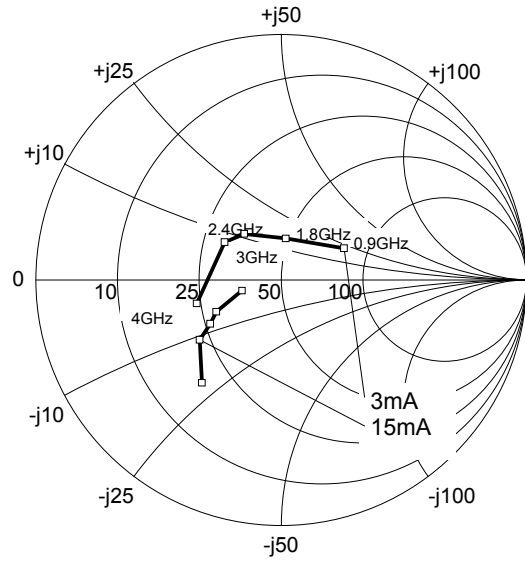

This datasheet has been downloaded from:

www.DatasheetCatalog.com

Datasheets for electronic components.



LittleDiode supplies new, hard to find or obsolete electronic components and semiconductors all over the world.

With over two million different components listed you are sure to find the part you need.

Feel free to visit us today at our online store:

LittleDiode.com

Looking forward to providing you with the best possible service.