

BFR30LT1, BFR31LT1

JFET Amplifiers

N-Channel

Features

- Pb-Free Package is Available

MAXIMUM RATINGS

Rating	Symbol	Value	Unit
Drain-Source Voltage	V_{DS}	25	Vdc
Gate-Source Voltage	V_{GS}	25	Vdc

Maximum ratings are those values beyond which device damage can occur. Maximum ratings applied to the device are individual stress limit values (not normal operating conditions) and are not valid simultaneously. If these limits are exceeded, device functional operation is not implied, damage may occur and reliability may be affected.

THERMAL CHARACTERISTICS

Characteristic	Symbol	Max	Unit
Total Device Dissipation (Note 1) $T_A = 25^\circ\text{C}$ Derate above 25°C	P_D	225 1.8	mW mW/ $^\circ\text{C}$
Thermal Resistance, Junction-to-Ambient	$R_{\theta JA}$	556	$^\circ\text{C}/\text{W}$
Total Device Dissipation Alumina Substrate, (Note 2) $T_A = 25^\circ\text{C}$ Derate above 25°C	P_D	300 2.4	mW mW/ $^\circ\text{C}$
Thermal Resistance, Junction-to-Ambient	$R_{\theta JA}$	417	$^\circ\text{C}/\text{W}$
Junction and Storage Temperature	T_J, T_{stg}	-55 to +150	$^\circ\text{C}$

- Device mounted on FR4 glass epoxy printed circuit board using the recommended footprint.
- Alumina = $0.4 \times 0.3 \times 0.024$ in 99.5% alumina.



ON Semiconductor®

<http://onsemi.com>

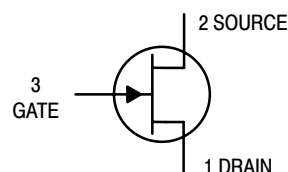

MARKING DIAGRAM

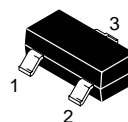

SOT-23
CASE 318
STYLE 10

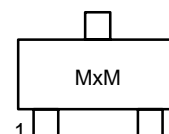

x = 1 or 2
M = Date Code

ORDERING INFORMATION

Device	Package	Shipping†
BFR30LT1	SOT-23	3000/Tape & Reel
BFR30LT1G	SOT-23 (Pb-Free)	3000/Tape & Reel
BFR31LT1	SOT-23	3000/Tape & Reel
BFR31LT1G	SOT-23 (Pb-Free)	3000/Tape & Reel

†For information on tape and reel specifications, including part orientation and tape sizes, please refer to our Tape and Reel Packaging Specifications Brochure, BRD8011/D.

BFR30LT1, BFR31LT1

ELECTRICAL CHARACTERISTICS (T_A = 25°C unless otherwise noted)

Characteristic		Symbol	Min	Max	Unit
OFF CHARACTERISTICS					
Gate Reverse Current	(V _{GS} = 10 Vdc, V _{DS} = 0)	I _{GSS}	–	0.2	nAdc
Gate Source Cutoff Voltage	(I _D = 0.5 nAdc, V _{DS} = 10 Vdc)	V _{GS(OFF)}	–	5.0	Vdc
			–	2.5	
Gate Source Voltage	(I _D = 1.0 mAdc, V _{DS} = 10 Vdc)	V _{GS}	–0.7	–3.0	Vdc
			–	–1.3	
	(I _D = 50 μAdc, V _{DS} = 10 Vdc)		–	–4.0	
			–	–2.0	

ON CHARACTERISTICS

Zero-Gate-Voltage Drain Current	(V _{DS} = 10 Vdc, V _{GS} = 0)	BFR30 BFR31	I _{DSS}	4.0 1.0	10 5.0	mAdc
---------------------------------	---	----------------	------------------	------------	-----------	------

SMALL-SIGNAL CHARACTERISTICS

Forward Transconductance	(I _D = 1.0 mAdc, V _{DS} = 10 Vdc, f = 1.0 kHz)	BFR30 BFR31	y _{fs}	1.0 1.5	4.0 4.5	mmhos
	(I _D = 200 μAdc, V _{DS} = 10 Vdc, f = 1.0 kHz)	BFR30 BFR31		0.5 0.75	– –	
Output Admittance	(I _D = 1.0 mAdc, V _{DS} = 10 Vdc, f = 1.0 kHz)	BFR30	y _{os}	40	25	μmhos
	(I _D = 200 μAdc, V _{DS} = 10 Vdc)	BFR31		20	15	
Input Capacitance	(I _D = 1.0 mAdc, V _{DS} = 10 Vdc, f = 1.0 MHz)		C _{iss}	–	5.0	pF
	(I _D = 200 μAdc, V _{DS} = 10 Vdc, f = 1.0 MHz)			–	4.0	
Reverse Transfer Capacitance	(I _D = 1.0 mAdc, V _{DS} = 10 Vdc, f = 1.0 MHz)		C _{rss}	–	1.5	pF
	(I _D = 200 μAdc, V _{DS} = 10 Vdc, f = 1.0 MHz)			–	1.5	

TYPICAL CHARACTERISTICS

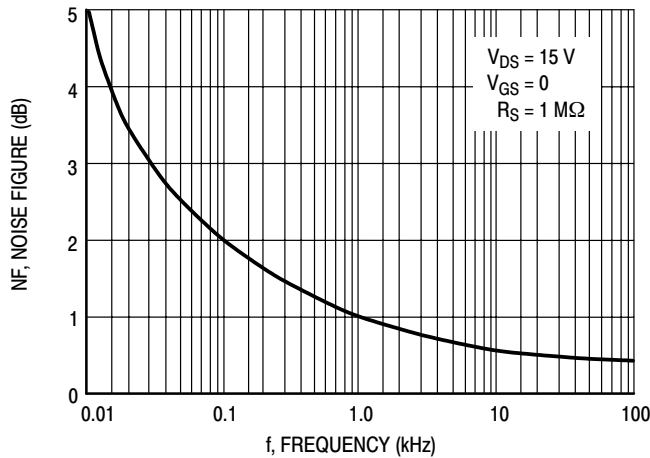

Figure 1. Noise Figure versus Frequency

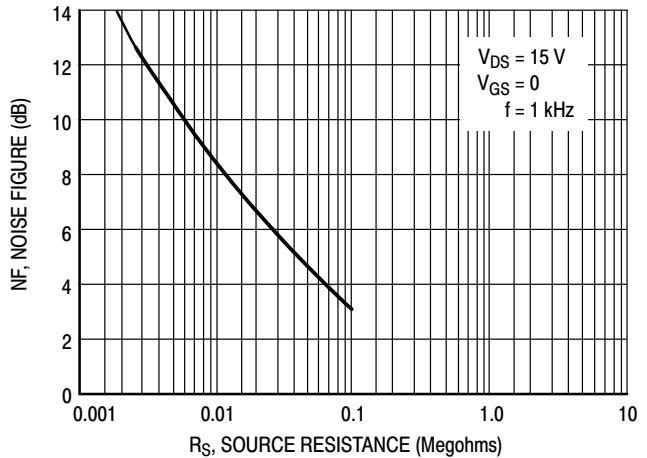

Figure 2. Noise Figure versus Source Resistance

BFR30LT1, BFR31LT1

TYPICAL CHARACTERISTICS

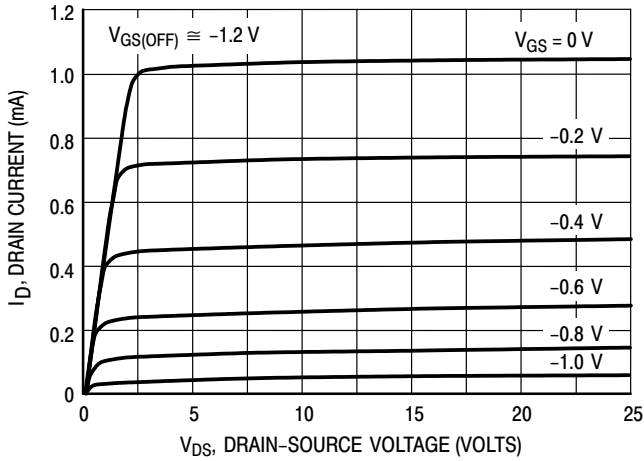

Figure 3. Typical Drain Characteristics

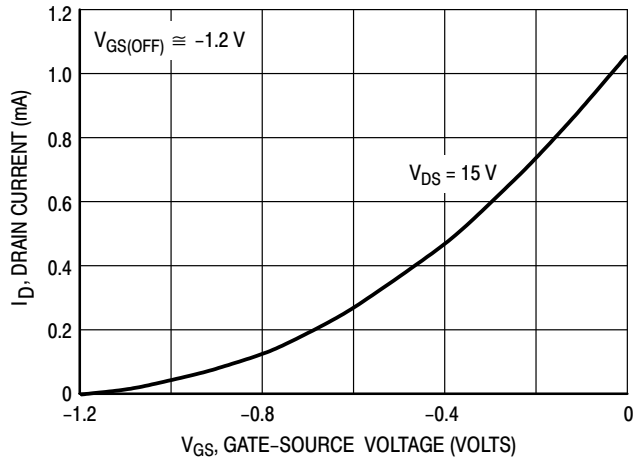

Figure 4. Common Source Transfer Characteristics

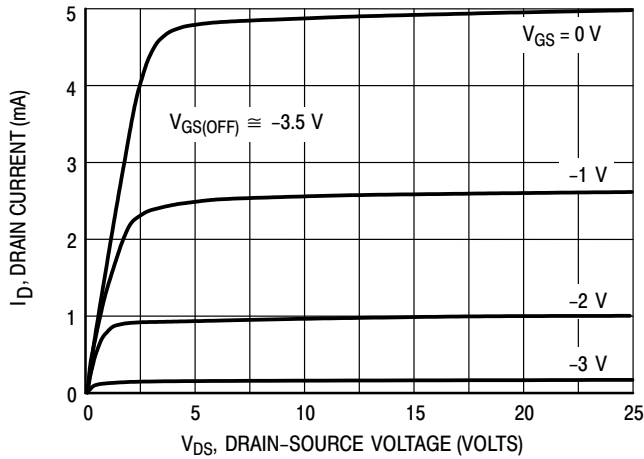

Figure 5. Typical Drain Characteristics

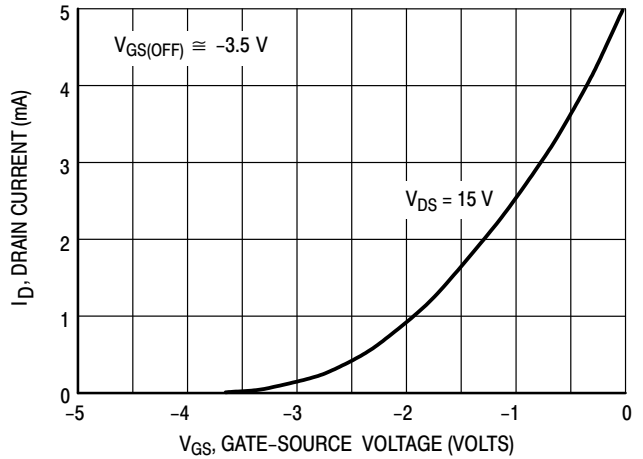

Figure 6. Common Source Transfer Characteristics

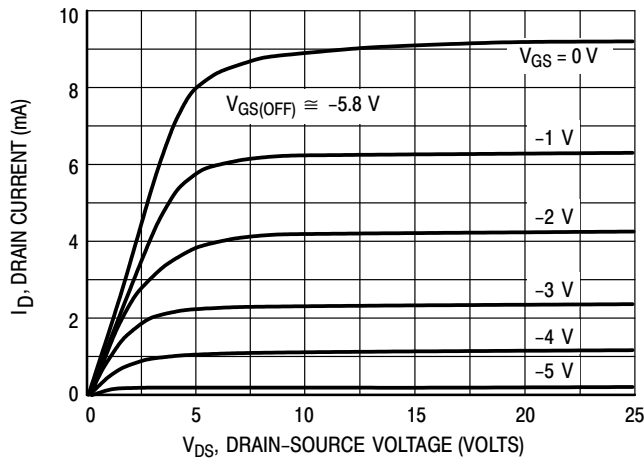

Figure 7. Typical Drain Characteristics

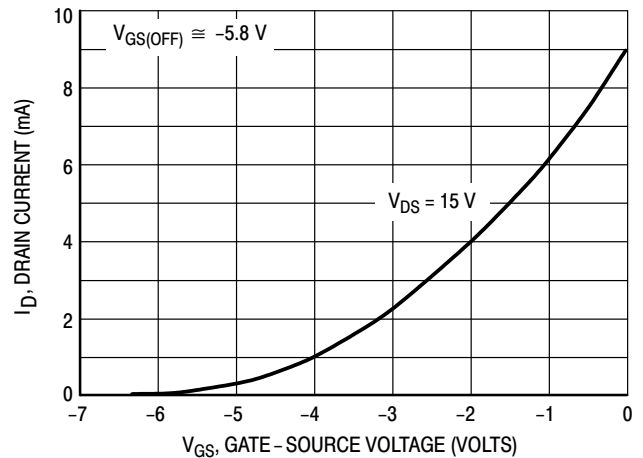

Figure 8. Common Source Transfer Characteristics

Note: Graphical data is presented for dc conditions. Tabular data is given for pulsed conditions (Pulse Width = 630 ms, Duty Cycle = 10%). Under dc conditions, self heating in higher I_{DSS} units reduces I_{DSS} .

BFR30LT1, BFR31LT1

PACKAGE DIMENSIONS

SOT-23 (TO-236)
CASE 318-08
ISSUE AK

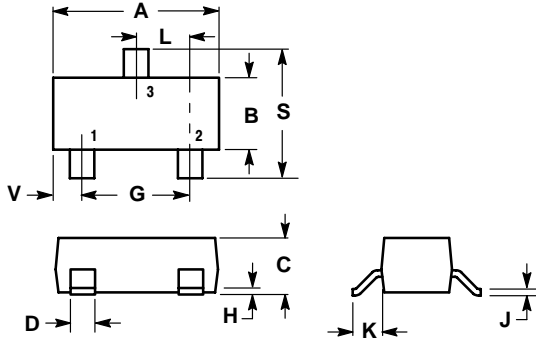

NOTES:

1. DIMENSIONING AND TOLERANCING PER ANSI Y14.5M, 1982.
2. CONTROLLING DIMENSION: INCH.
3. MAXIMUM LEAD THICKNESS INCLUDES LEAD FINISH THICKNESS. MINIMUM LEAD THICKNESS IS THE MINIMUM THICKNESS OF BASE MATERIAL.
4. 318-01 THRU -07 AND -09 OBSOLETE, NEW STANDARD 318-08.

DIM	INCHES		MILLIMETERS	
	MIN	MAX	MIN	MAX
A	0.1102	0.1197	2.80	3.04
B	0.0472	0.0551	1.20	1.40
C	0.0350	0.0440	0.89	1.11
D	0.0150	0.0200	0.37	0.50
G	0.0701	0.0807	1.78	2.04
H	0.0005	0.0040	0.013	0.100
J	0.0034	0.0070	0.085	0.177
K	0.0140	0.0285	0.35	0.69
L	0.0350	0.0401	0.89	1.02
S	0.0830	0.1039	2.10	2.64
V	0.0177	0.0236	0.45	0.60

STYLE 10:

1. DRAIN
2. SOURCE
3. GATE

SOLDERING FOOTPRINT*

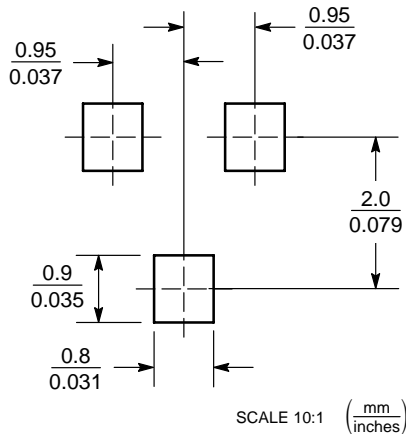

*For additional information on our Pb-Free strategy and soldering details, please download the ON Semiconductor Soldering and Mounting Techniques Reference Manual, SOLDERRM/D.

ON Semiconductor and  are registered trademarks of Semiconductor Components Industries, LLC (SCILLC). SCILLC reserves the right to make changes without further notice to any products herein. SCILLC makes no warranty, representation or guarantee regarding the suitability of its products for any particular purpose, nor does SCILLC assume any liability arising out of the application or use of any product or circuit, and specifically disclaims any and all liability, including without limitation special, consequential or incidental damages. "Typical" parameters which may be provided in SCILLC data sheets and/or specifications can and do vary in different applications and actual performance may vary over time. All operating parameters, including "Typicals" must be validated for each customer application by customer's technical experts. SCILLC does not convey any license under its patent rights nor the rights of others. SCILLC products are not designed, intended, or authorized for use as components in systems intended for surgical implant into the body, or other applications intended to support or sustain life, or for any other application in which the failure of the SCILLC product could create a situation where personal injury or death may occur. Should Buyer purchase or use SCILLC products for any such unintended or unauthorized application, Buyer shall indemnify and hold SCILLC and its officers, employees, subsidiaries, affiliates, and distributors harmless against all claims, costs, damages, and expenses, and reasonable attorney fees arising out of, directly or indirectly, any claim of personal injury or death associated with such unintended or unauthorized use, even if such claim alleges that SCILLC was negligent regarding the design or manufacture of the part. SCILLC is an Equal Opportunity/Affirmative Action Employer. This literature is subject to all applicable copyright laws and is not for resale in any manner.

PUBLICATION ORDERING INFORMATION

LITERATURE FULFILLMENT:

Literature Distribution Center for ON Semiconductor
P.O. Box 61312, Phoenix, Arizona 85082-1312 USA
Phone: 480-829-7710 or 800-344-3860 Toll Free USA/Canada
Fax: 480-829-7709 or 800-344-3867 Toll Free USA/Canada
Email: orderlit@onsemi.com

N. American Technical Support: 800-282-9855 Toll Free
USA/Canada

Japan: ON Semiconductor, Japan Customer Focus Center
2-9-1 Kamimeguro, Meguro-ku, Tokyo, Japan 153-0051
Phone: 81-3-5773-3850

ON Semiconductor Website: <http://onsemi.com>

Order Literature: <http://www.onsemi.com/litorder>

For additional information, please contact your local Sales Representative.



LittleDiode supplies new, hard to find or obsolete electronic components and semiconductors all over the world.

With over two million different components listed you are sure to find the part you need.

Feel free to visit us today at our online store:

LittleDiode.com

Looking forward to providing you with the best possible service.