

NPN Silicon RF Transistor

BFQ 73S

- For low-noise, low-distortion broadband amplifiers in antenna and telecommunications systems up to 2 GHz at collector currents from 10 mA to 70 mA.
- Hermetically sealed ceramic package.
- HiRel/Mil screening available.
- CECC-type available: CECC 50002/261.

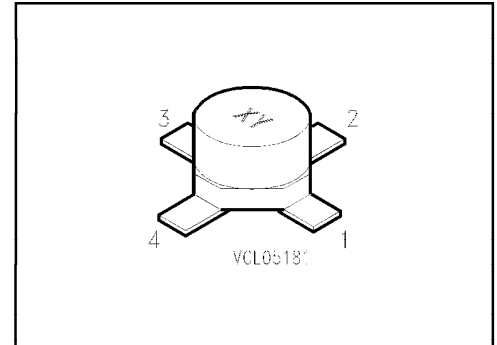

ESD: Electrostatic discharge sensitive device, observe handling precautions!

Type	Marking	Ordering Code (tape and reel)	Pin Configuration				Package ¹⁾
			1	2	3	4	
BFQ 73S	73S	Q62702-F1104	B	E	C	E	Cerrec-X

Maximum Ratings

Parameter	Symbol	Values	Unit
Collector-emitter voltage	V_{CE0}	15	V
Collector-base voltage	V_{CB0}	20	
Emitter-base voltage	V_{EB0}	3	
Collector current	I_C	100	mA
Total power dissipation, $T_s \leq 110\text{ °C}^3)$	P_{tot}	500	mW
Junction temperature	T_j	175	°C
Ambient temperature range	T_A	- 65 ... + 175	
Storage temperature range	T_{stg}	- 65 ... + 175	

Thermal Resistance

Junction - ambient ²⁾	$R_{th\ JA}$	≤ 210	K/W
Junction - soldering point ³⁾	$R_{th\ JS}$	≤ 130	

1) For detailed information see chapter Package Outlines.

2) Package mounted on alumina $15\text{ mm} \times 16.7\text{ mm} \times 0.7\text{ mm}$.

3) T_s is measured on the collector lead at the soldering point to the pcb.

Electrical Characteristicsat $T_A = 25\text{ °C}$, unless otherwise specified.

Parameter	Symbol	Values			Unit
		min.	typ.	max.	

DC Characteristics

Collector-emitter breakdown voltage $I_C = 1\text{ mA}$, $I_B = 0$	$V_{(BR)CE0}$	15	–	–	V
Collector-base cutoff current $V_{CB} = 10\text{ V}$, $I_E = 0$	I_{CB0}	–	–	100	nA
Emitter-base cutoff current $V_{EB} = 2\text{ V}$, $I_C = 0$	I_{EB0}	–	–	10	μA
DC current gain $I_C = 50\text{ mA}$, $V_{CE} = 5\text{ V}$	h_{FE}	30	90	250	–
Collector-emitter saturation voltage $I_C = 75\text{ mA}$, $I_B = 7.5\text{ mA}$	V_{CEsat}	–	0.2	0.5	V

Electrical Characteristics

at $T_A = 25\text{ }^\circ\text{C}$, unless otherwise specified.

Parameter	Symbol	Values			Unit
		min.	typ.	max.	

AC Characteristics

Transition frequency $I_C = 50\text{ mA}$, $V_{CE} = 5\text{ V}$, $f = 200\text{ MHz}$ $I_C = 75\text{ mA}$, $V_{CE} = 5\text{ V}$, $f = 200\text{ MHz}$	f	–	5.3 5.4	–	GHz
Collector-base capacitance $V_{CB} = 10\text{ V}$, $V_{BE} = v_{be} = 0$, $f = 1\text{ MHz}$	C_{cb}	–	0.9	–	pF
Collector-emitter capacitance $V_{CE} = 10\text{ V}$, $V_{BE} = v_{be} = 0$, $f = 1\text{ MHz}$	C_{ce}	–	0.4	–	
Input capacitance $V_{EB} = 0.5\text{ V}$, $I_C = i_c = 0$, $f = 1\text{ MHz}$	C_{ibo}	–	5	–	
Output capacitance $V_{CE} = 10\text{ V}$, $V_{BE} = v_{be} = 0$, $f = 1\text{ MHz}$	C_{obs}	–	1.3	–	
Noise figure $I_C = 5\text{ mA}$, $V_{CE} = 10\text{ V}$, $f = 10\text{ MHz}$, $Z_S = 50\text{ }\Omega$ $I_C = 50\text{ mA}$, $V_{CE} = 5\text{ V}$, $f = 800\text{ MHz}$, $Z_S = Z_{Sopt}$	F	–	0.9 2.5	–	dB
Power gain $I_C = 50\text{ mA}$, $V_{CE} = 5\text{ V}$, $f = 800\text{ MHz}$, $Z_S = Z_{Sopt}$, $Z_L = Z_{Lopt}$	G_{pe}	–	15	–	
Transducer gain $I_C = 50\text{ mA}$, $V_{CE} = 5\text{ V}$, $f = 1\text{ GHz}$, $Z_0 = 50\text{ }\Omega$	$ S_{21e} ^2$	–	10.5	–	
Linear output voltage two-tone intermodulation test $I_C = 50\text{ mA}$, $V_{CE} = 10\text{ V}$, $d_{IM} = 60\text{ dB}$ $f_1 = 806\text{ MHz}$, $f_2 = 810\text{ MHz}$, $Z_S = Z_L = 50\text{ }\Omega$	$V_{o1} = V_{o2}$	–	400	–	mV
Third order intercept point $I_C = 50\text{ mA}$, $V_{CE} = 10\text{ V}$, $f = 800\text{ MHz}$	IP_3	–	35	–	dBm

Total power dissipation $P_{tot} = f(T_A^*; T_S)$
 * Package mounted on alumina

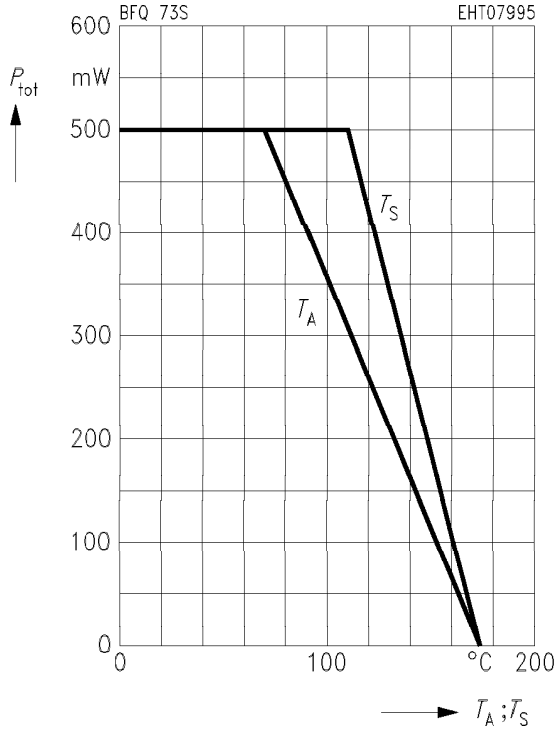

Transition frequency $f_T = f(I_C)$
 $V_{CE} = 5 \text{ V}, f = 200 \text{ MHz}$

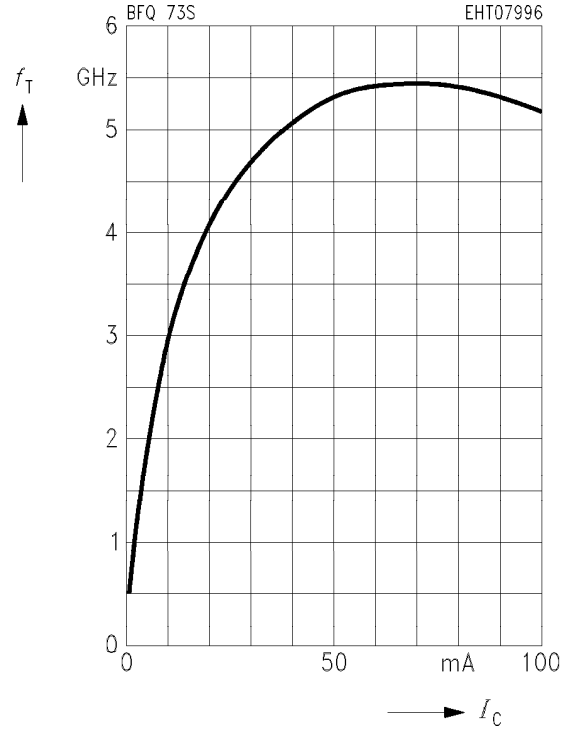

Collector-base capacitance $C_{cb} = f(V_{CB})$
 $V_{BE} = v_{be} = 0, f = 1 \text{ MHz}$

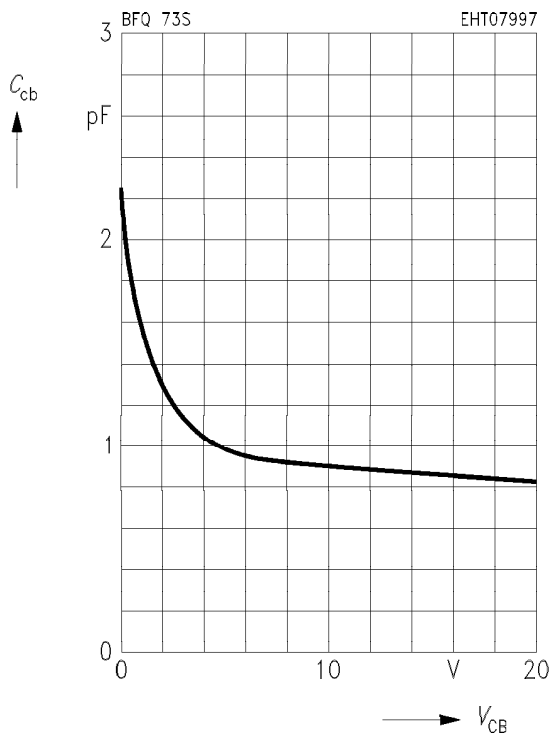

Common Emitter Noise Parameters

f	F_{min}	$G_p(F_{min})$	Γ_{opt}		R_N	N	$F_{50\Omega}$	$G_p(F_{50\Omega})$
GHz	dB	dB	MAG	ANG	Ω	—	dB	dB

$I_C = 5 \text{ mA}, V_{CE} = 5 \text{ V}, Z_0 = 50 \Omega$

0.01	0.9	—	(Z _s = 50 Ω)		—	—	—	—
------	-----	---	-------------------------	--	---	---	---	---

$I_C = 50 \text{ mA}, V_{CE} = 5 \text{ V}, Z_0 = 50 \Omega$

0.01	2.0	—	(Z _s = 50 Ω)		—	—	—	—
0.8	2.5	14	0.41	163	9	0.39	3.8	—

Noise figure $F = f(I_C)$

$V_{CE} = 10 \text{ V}, f = 10 \text{ MHz}, Z_S = 50 \Omega$

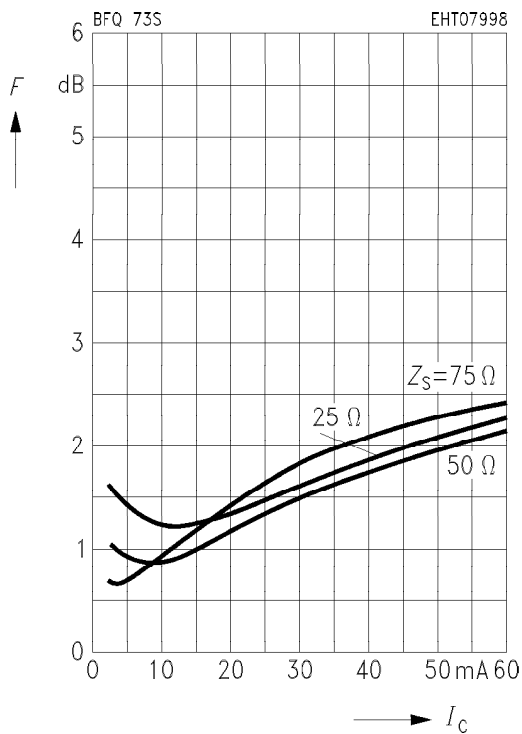

Noise figure $F = f(I_C)$

$V_{CE} = 5 \text{ V}, f = 800 \text{ MHz}$

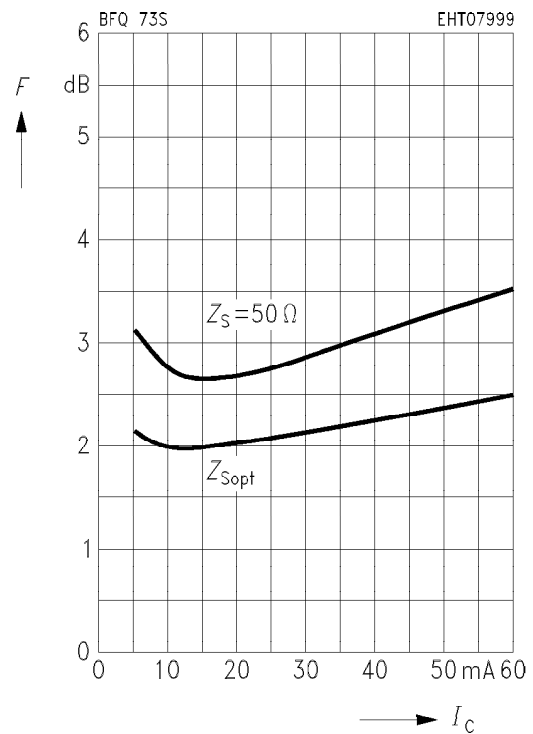

**Circles of constant noise figure $F = f(Z_s)$
and available power gain $G_{av} = f(Z_s)$**

$I_C = 50 \text{ mA}$, $V_{CE} = 5 \text{ V}$, $f = 800 \text{ MHz}$,
 $Z_0 = 50 \Omega$

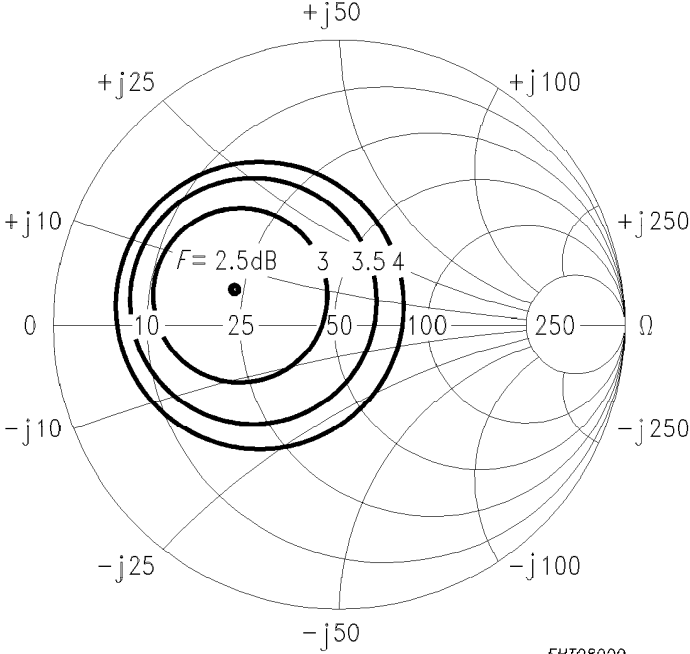

Common Emitter Power Gain

Power gain G_{ms} , $|S_{21e}|^2 = f(I_c)$
 $V_{CE} = 5 \text{ V}, f = 200 \text{ MHz}, Z_0 = 50 \Omega$

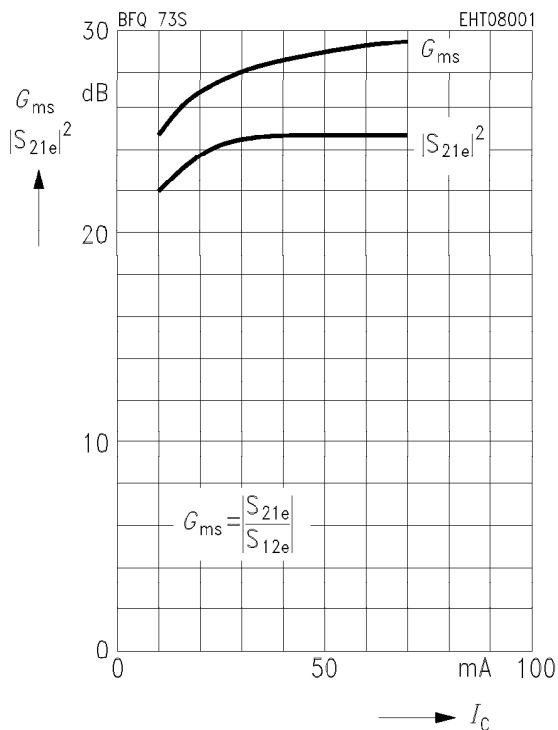

Power gain G_{ms} , $|S_{21e}|^2 = f(I_c)$
 $V_{CE} = 5 \text{ V}, f = 500 \text{ MHz}, Z_0 = 50 \Omega$

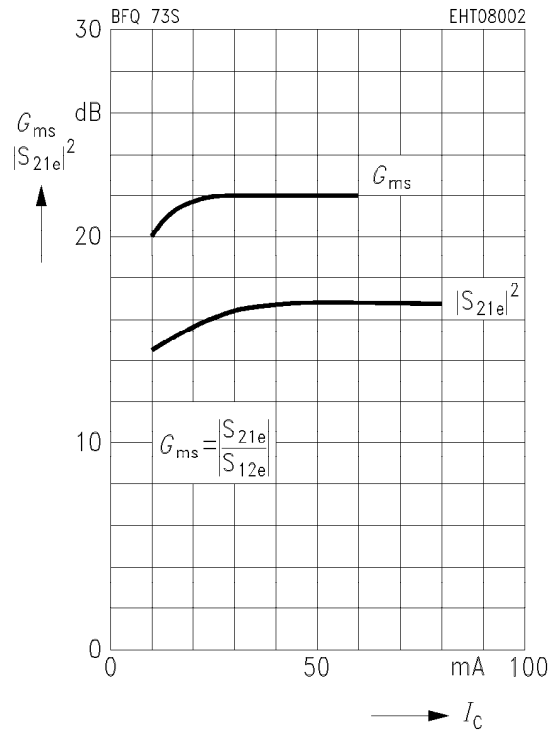

Power gain G_{ma} , $|S_{21e}|^2 = f(I_c)$
 $V_{CE} = 5 \text{ V}, f = 800 \text{ MHz}, Z_0 = 50 \Omega$

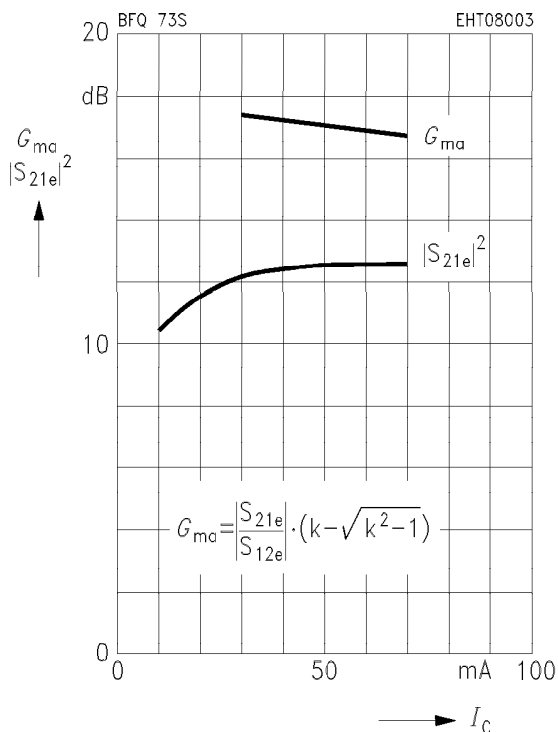

Power gain G_{ma} , $|S_{21e}|^2 = f(I_c)$
 $V_{CE} = 5 \text{ V}, f = 1.5 \text{ GHz}, Z_0 = 50 \Omega$

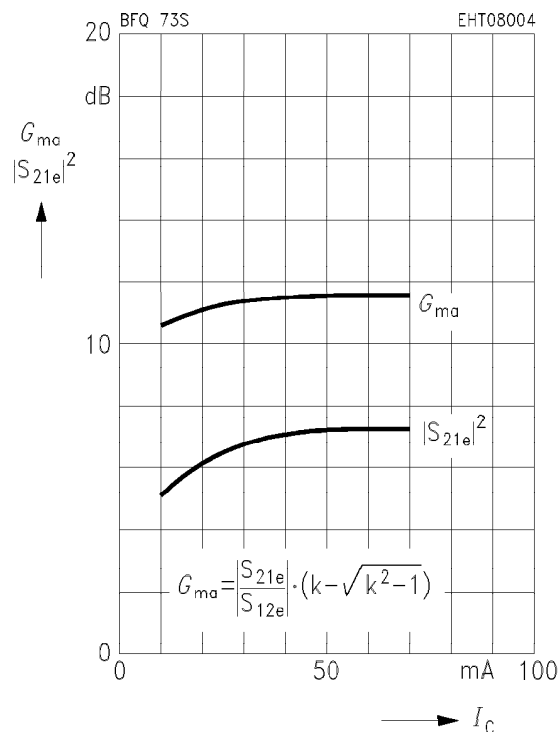

Power gain G_{ma} , G_{ms} , $|S_{21e}|^2 = f(f)$
 $I_C = 10 \text{ mA}$, $V_{CE} = 5 \text{ V}$, $Z_0 = 50 \Omega$

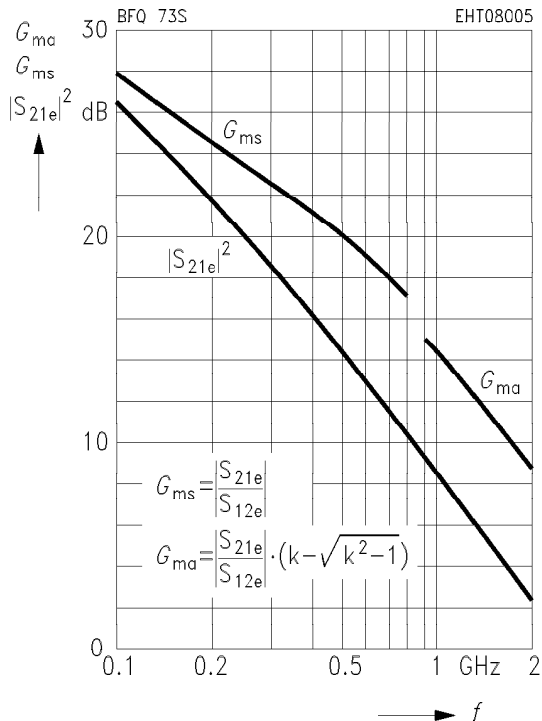

Power gain G_{ma} , G_{ms} , $|S_{21e}|^2 = f(f)$
 $I_C = 30 \text{ mA}$, $V_{CE} = 5 \text{ V}$, $Z_0 = 50 \Omega$

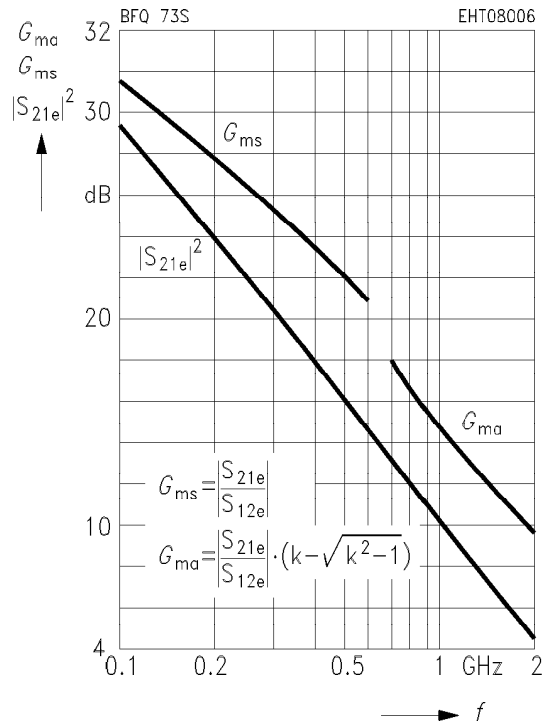

Power gain G_{ma} , G_{ms} , $|S_{21e}|^2 = f(f)$
 $I_C = 50 \text{ mA}$, $V_{CE} = 5 \text{ V}$, $Z_0 = 50 \Omega$

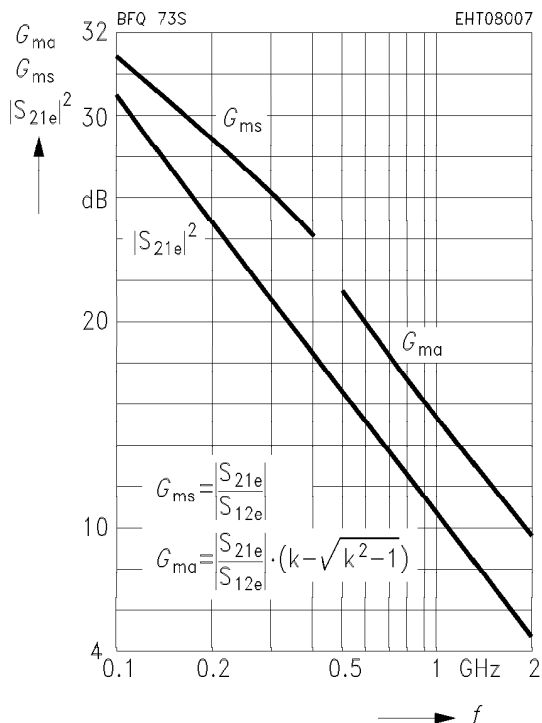

Power gain G_{ma} , G_{ms} , $|S_{21e}|^2 = f(f)$
 $I_C = 70 \text{ mA}$, $V_{CE} = 5 \text{ V}$, $Z_0 = 50 \Omega$

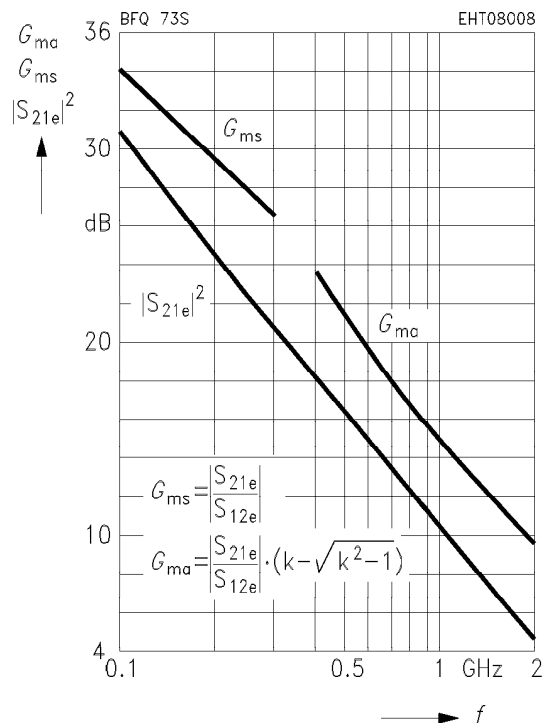

Common Emitter S Parameters

f	S_{11}		S_{21}		S_{12}		S_{22}	
GHz	MAG	ANG	MAG	ANG	MAG	ANG	MAG	ANG
$I_C = 10 \text{ mA}, V_{CE} = 5 \text{ V}, Z_0 = 50 \Omega$								
0.1	0.78	- 92	20.39	132	0.034	48	0.71	- 39
0.3	0.75	- 152	8.63	97	0.047	30	0.34	- 57
0.5	0.75	- 169	5.27	84	0.053	31	0.26	- 61
0.8	0.75	177	3.29	71	0.060	35	0.23	- 68
1.0	0.76	171	2.63	63	0.066	39	0.22	- 73
1.2	0.77	165	2.21	57	0.073	42	0.22	- 79
1.4	0.77	159	1.91	50	0.081	43	0.23	- 84
1.6	0.77	155	1.68	44	0.089	45	0.24	- 91
1.8	0.78	151	1.49	38	0.098	45	0.25	- 98
2.0	0.79	147	1.34	32	0.107	46	0.26	- 106

$S_{11}, S_{22} = f(f)$

$I_C = 10 \text{ mA}, V_{CE} = 5 \text{ V}, Z_0 = 50 \Omega$

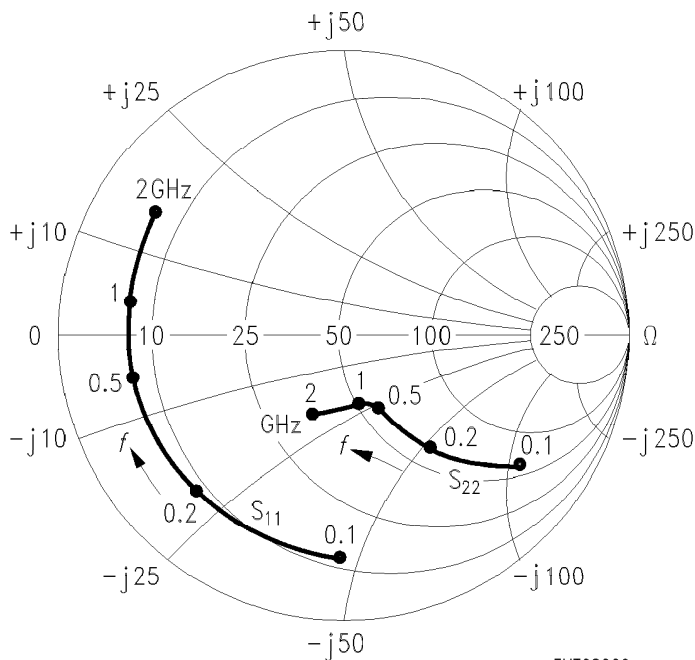

EHT08009

$S_{12}, S_{21} = f(f)$

$I_C = 10 \text{ mA}, V_{CE} = 5 \text{ V}, Z_0 = 50 \Omega$

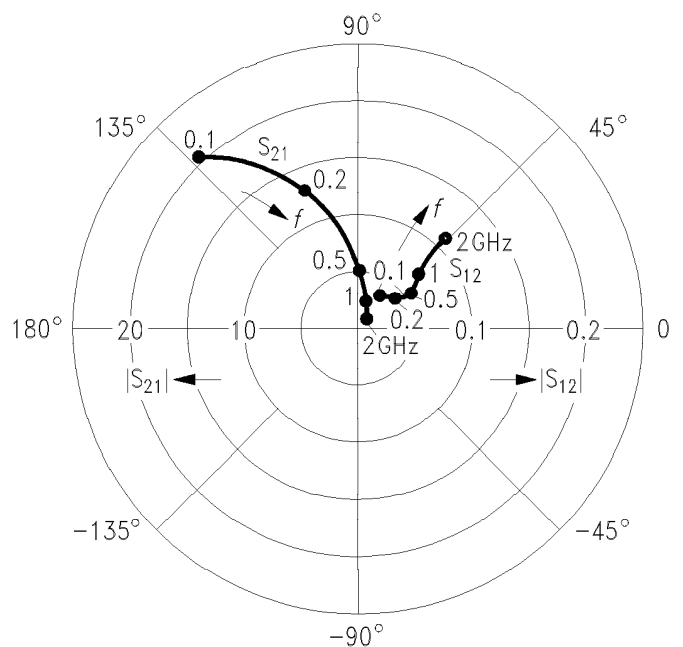

EHT08010

Common Emitter S Parameters (continued)

f	S_{11}		S_{21}		S_{12}		S_{22}	
GHz	MAG	ANG	MAG	ANG	MAG	ANG	MAG	ANG
$I_C = 30 \text{ mA}, V_{CE} = 5 \text{ V}, Z_0 = 50 \Omega$								
0.1	0.72	- 30	31.12	117	0.022	44	0.49	- 66
0.3	0.73	- 168	11.01	91	0.029	45	0.20	- 103
0.5	0.74	- 179	6.61	82	0.040	51	0.15	- 119
0.8	0.73	170	4.10	71	0.056	55	0.14	- 132
1.0	0.75	166	3.27	64	0.067	56	0.13	- 139
1.2	0.75	161	2.75	59	0.079	56	0.13	- 144
1.4	0.76	156	2.38	53	0.090	55	0.14	- 146
1.6	0.75	152	2.09	47	0.102	54	0.14	- 148
1.8	0.76	149	1.85	41	0.113	52	0.16	- 152
2.0	0.78	145	1.67	36	0.123	51	0.17	- 157

$S_{11}, S_{22} = f(f)$
 $I_C = 30 \text{ mA}, V_{CE} = 5 \text{ V}, Z_0 = 50 \Omega$

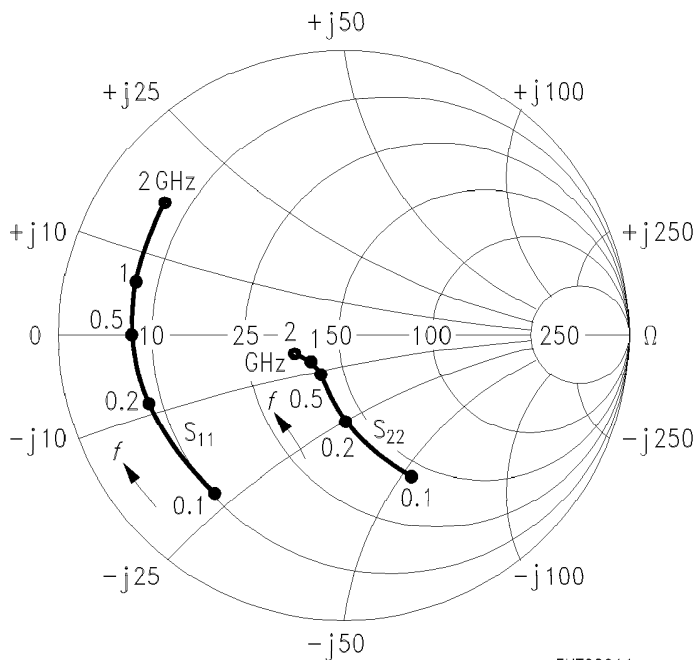

EHT08011

$S_{12}, S_{21} = f(f)$
 $I_C = 30 \text{ mA}, V_{CE} = 5 \text{ V}, Z_0 = 50 \Omega$

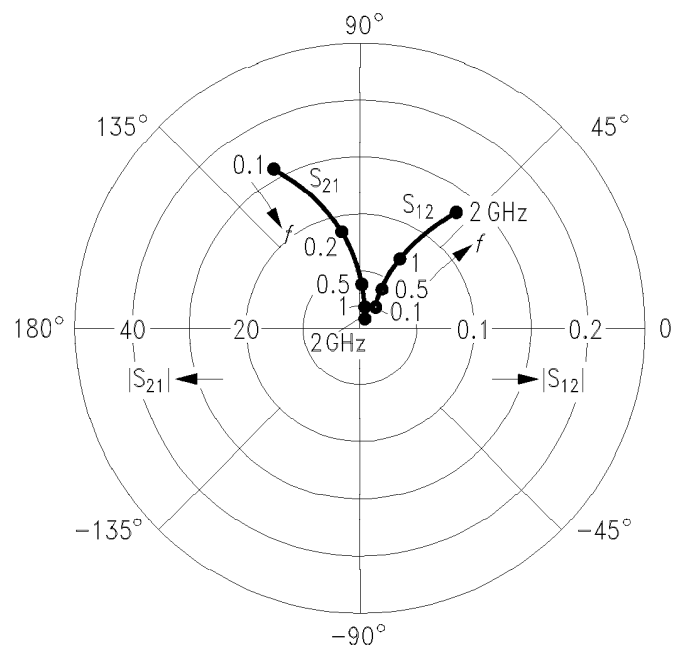

EHT08012

Common Emitter S Parameters (continued)

<i>f</i>	<i>S</i> ₁₁		<i>S</i> ₂₁		<i>S</i> ₁₂		<i>S</i> ₂₂	
	MAG	ANG	MAG	ANG	MAG	ANG	MAG	ANG
<i>I</i> _C = 50 mA, <i>V</i> _{CE} = 5 V, <i>Z</i> ₀ = 50 Ω								
0.1	0.72	-142	33.86	111	0.018	43	0.42	-79
0.3	0.73	-173	11.49	90	0.027	52	0.19	-122
0.5	0.73	177	6.87	81	0.038	58	0.16	-139
0.8	0.73	169	4.25	70	0.056	60	0.15	-152
1.0	0.75	165	3.39	64	0.068	60	0.15	-158
1.2	0.75	160	2.85	59	0.080	59	0.15	-162
1.4	0.75	155	2.46	53	0.092	58	0.15	-165
1.6	0.75	152	2.16	48	0.105	56	0.16	-166
1.8	0.75	148	1.92	42	0.116	53	0.17	-169
2.0	0.78	144	1.72	37	0.126	52	0.18	-172

*S*₁₁, *S*₂₂ = *f*(*f*)
*I*_C = 50 mA, *V*_{CE} = 5 V, *Z*₀ = 50 Ω

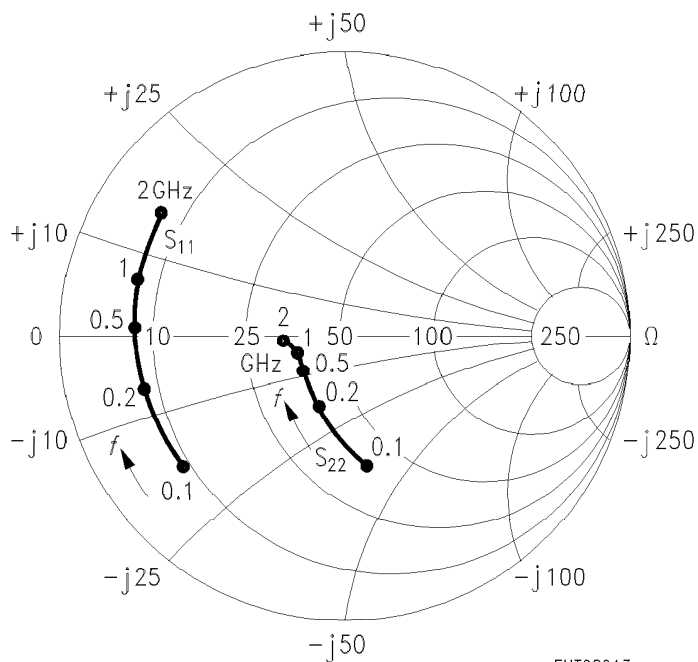

EHT08013

*S*₁₂, *S*₂₁ = *f*(*f*)
*I*_C = 50 mA, *V*_{CE} = 5 V, *Z*₀ = 50 Ω

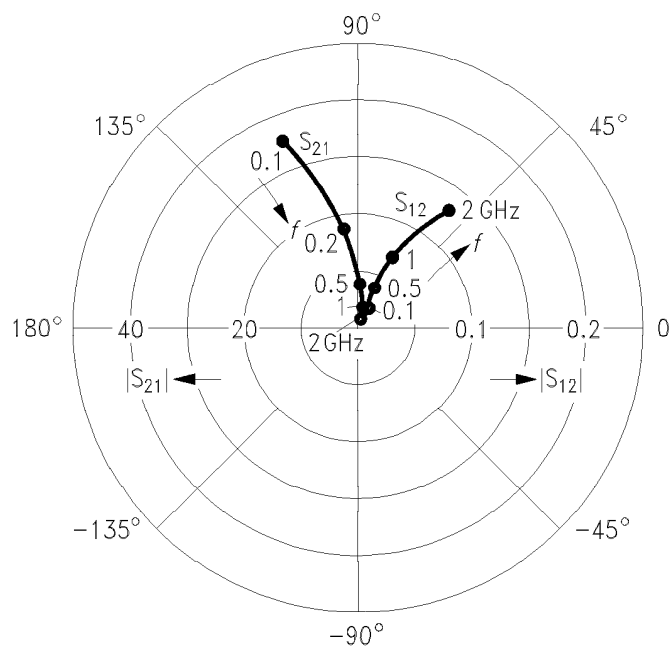

EHT08014

Common Emitter S Parameters (continued)

<i>f</i>	<i>S</i> ₁₁		<i>S</i> ₂₁		<i>S</i> ₁₂		<i>S</i> ₂₂	
	MAG	ANG	MAG	ANG	MAG	ANG	MAG	ANG
<i>I</i> _C = 70 mA, <i>V</i> _{CE} = 5 V, <i>Z</i> ₀ = 50 Ω								
0.1	0.72	-149	34.51	108	0.014	42	0.37	-87
0.3	0.73	-175	11.47	89	0.025	56	0.18	-130
0.5	0.73	176	6.84	80	0.037	62	0.16	-146
0.8	0.74	168	4.24	70	0.056	63	0.16	-157
1.0	0.75	164	3.38	64	0.069	62	0.16	-163
1.2	0.75	159	2.84	59	0.081	61	0.16	-167
1.4	0.76	155	2.45	53	0.093	59	0.16	-170
1.6	0.75	151	2.15	48	0.105	57	0.16	-171
1.8	0.77	148	1.91	42	0.177	54	0.17	-173
2.0	0.78	144	1.71	38	0.127	52	0.18	-177

*S*₁₁, *S*₂₂ = *f*(*f*)
*I*_C = 70 mA, *V*_{CE} = 5 V, *Z*₀ = 50 Ω

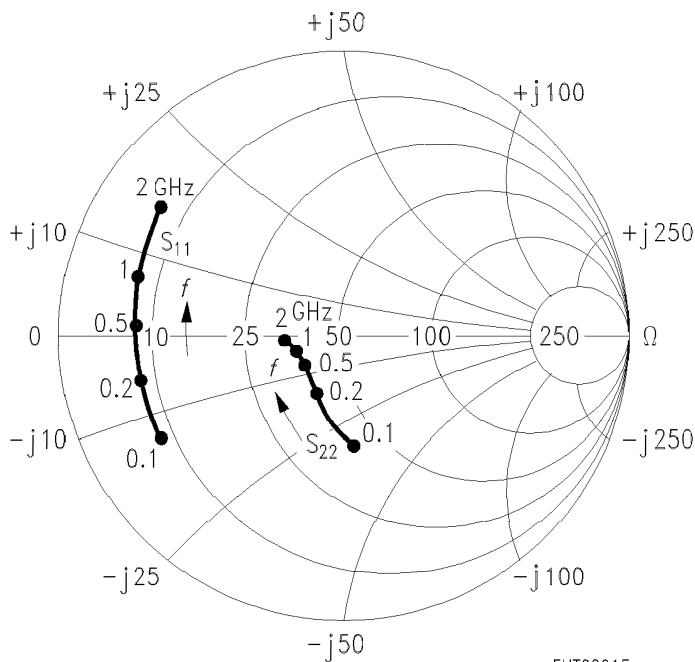

EHT08015

*S*₁₂, *S*₂₁ = *f*(*f*)
*I*_C = 70 mA, *V*_{CE} = 5 V, *Z*₀ = 50 Ω

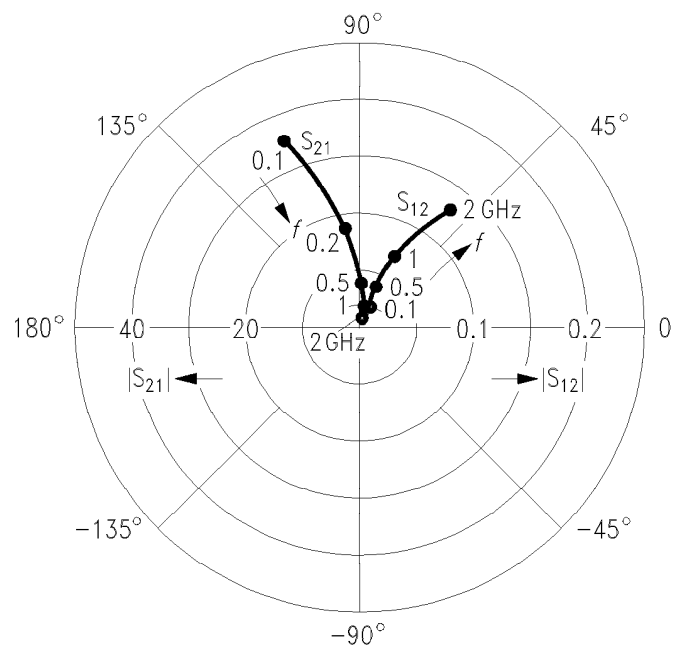

EHT08016

Common Emitter Large Signal Parameters

Linear output voltage $V_o = f(I_c)$

$d_{IM} = 60$ dB, $f_1 = 806$ MHz,

$f_2 = 810$ MHz, $Z_s = Z_L = 50 \Omega$

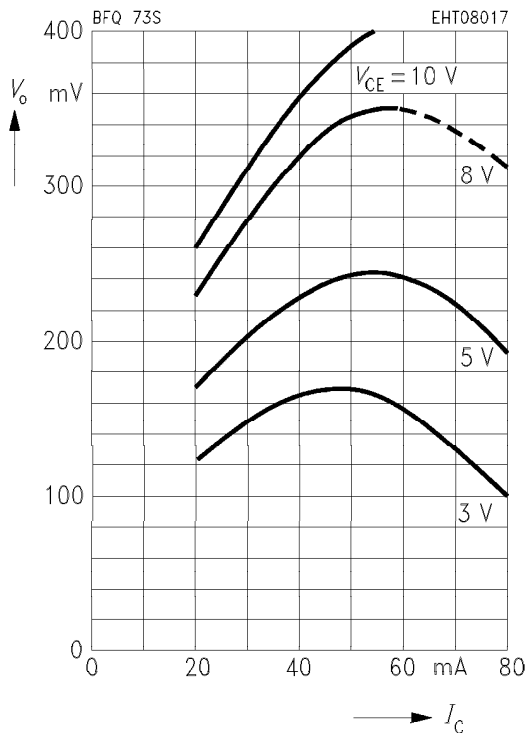

Note:

The transistor is driven by 2 adjacent signals f_1, f_2 with equal output power levels P_o for each carrier.

The distance d_{IM} between P_o and the third order intermodulation products P_{IM} ($2f_1 - f_2$ or $2f_2 - f_1$) is:

$$d_{IM} = P_o - P_{IM}$$

where $P_o = 10 \log (V_o^2 / (50 \Omega \cdot 1 \text{mW}))$ (dBm)

and $V_o =$ linear output voltage of each carrier.

The 3rd order intercept point IP_3 will be found by extrapolation to the point where P_{IM} would be identical to P_o :

$$IP_3 (\text{output}) = P_o + d_{IM}/2.$$

Linear output voltages for other d_{IM} (e.g. 50 dB) can be calculated thereby.



LittleDiode supplies new, hard to find or obsolete electronic components and semiconductors all over the world.

With over two million different components listed you are sure to find the part you need.

Feel free to visit us today at our online store:

LittleDiode.com

Looking forward to providing you with the best possible service.