

General Purpose Transistors

PNP Silicon

MAXIMUM RATINGS

Rating	Symbol	Value	Unit
Collector–Emitter Voltage	V_{CEO}	–45	Vdc
Emitter–Base Voltage	V_{EBO}	–5.0	Vdc
Collector Current — Continuous	I_C	–100	mAdc

DEVICE MARKING

BCW69LT1 = H1; BCW70LT1 = H2

THERMAL CHARACTERISTICS

Characteristic	Symbol	Max	Unit
Total Device Dissipation FR-5 Board ⁽¹⁾ $T_A = 25^\circ\text{C}$ Derate above 25°C	P_D	225	mW
		1.8	mW/ $^\circ\text{C}$
Thermal Resistance, Junction to Ambient	$R_{\theta JA}$	556	$^\circ\text{C}/\text{W}$
Total Device Dissipation Alumina Substrate, ⁽²⁾ $T_A = 25^\circ\text{C}$ Derate above 25°C	P_D	300	mW
		2.4	mW/ $^\circ\text{C}$
Thermal Resistance, Junction to Ambient	$R_{\theta JA}$	417	$^\circ\text{C}/\text{W}$
Junction and Storage Temperature	T_J, T_{stg}	–55 to +150	$^\circ\text{C}$

BCW69LT1 BCW70LT1

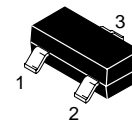

CASE 318–08, STYLE 6
SOT–23 (TO–236AB)

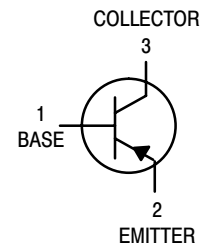

ELECTRICAL CHARACTERISTICS ($T_A = 25^\circ\text{C}$ unless otherwise noted)

Characteristic	Symbol	Min	Max	Unit
----------------	--------	-----	-----	------

OFF CHARACTERISTICS

Collector–Emitter Breakdown Voltage ($I_C = -2.0$ mAdc, $I_B = 0$)	$V_{(BR)CEO}$	–45	—	Vdc
Collector–Emitter Breakdown Voltage ($I_C = -100$ μ Adc, $V_{EB} = 0$)	$V_{(BR)CES}$	–50	—	Vdc
Emitter–Base Breakdown Voltage ($I_E = -10$ μ Adc, $I_C = 0$)	$V_{(BR)EBO}$	–5.0	—	Vdc
Collector Cutoff Current ($V_{CB} = -20$ Vdc, $I_E = 0$) ($V_{CB} = -20$ Vdc, $I_E = 0$, $T_A = 100^\circ\text{C}$)	I_{CBO}	—	–100 –10	nAdc μ Adc

- FR–5 = 1.0 x 0.75 x 0.062 in.
- Alumina = 0.4 x 0.3 x 0.024 in. 99.5% alumina

BCW69LT1 BCW70LT1

ELECTRICAL CHARACTERISTICS ($T_A = 25^\circ\text{C}$ unless otherwise noted) (Continued)

Characteristic	Symbol	Min	Max	Unit
ON CHARACTERISTICS				
DC Current Gain ($I_C = -2.0\text{ mA dc}$, $V_{CE} = -5.0\text{ V dc}$)	h_{FE}	120 215	260 500	—
Collector–Emitter Saturation Voltage ($I_C = -10\text{ mA dc}$, $I_B = -0.5\text{ mA dc}$)	$V_{CE(sat)}$	—	-0.3	Vdc
Base–Emitter On Voltage ($I_C = -2.0\text{ mA dc}$, $V_{CE} = -5.0\text{ V dc}$)	$V_{BE(on)}$	-0.6	-0.75	Vdc
SMALL-SIGNAL CHARACTERISTICS				
Output Capacitance ($I_E = 0$, $V_{CB} = -10\text{ V dc}$, $f = 1.0\text{ MHz}$)	C_{obo}	—	7.0	pF
Noise Figure ($I_C = -0.2\text{ mA dc}$, $V_{CE} = -5.0\text{ V dc}$, $R_S = 2.0\text{ k}\Omega$, $f = 1.0\text{ kHz}$, $BW = 200\text{ Hz}$)	N_F	—	10	dB

TYPICAL NOISE CHARACTERISTICS

($V_{CE} = -5.0\text{ V dc}$, $T_A = 25^\circ\text{C}$)

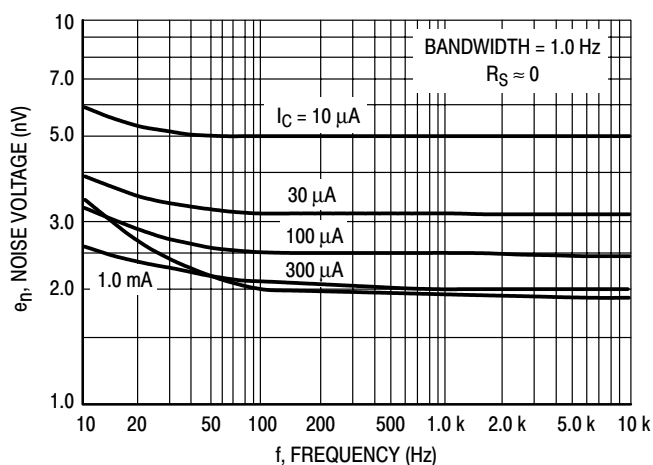

Figure 1. Noise Voltage

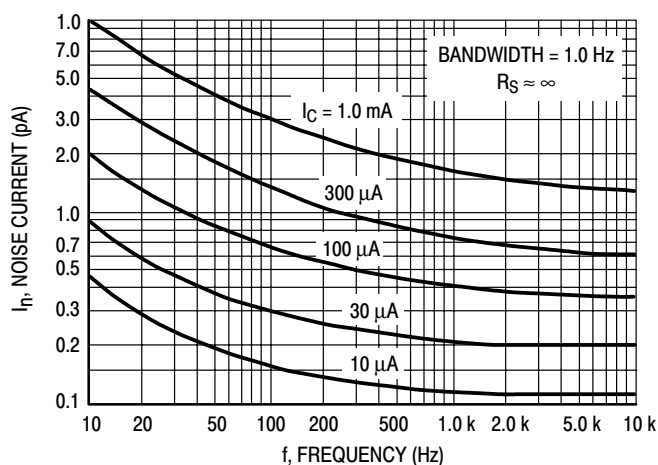

Figure 2. Noise Current

BCW69LT1 BCW70LT1

NOISE FIGURE CONTOURS

($V_{CE} = -5.0$ Vdc, $T_A = 25^\circ\text{C}$)

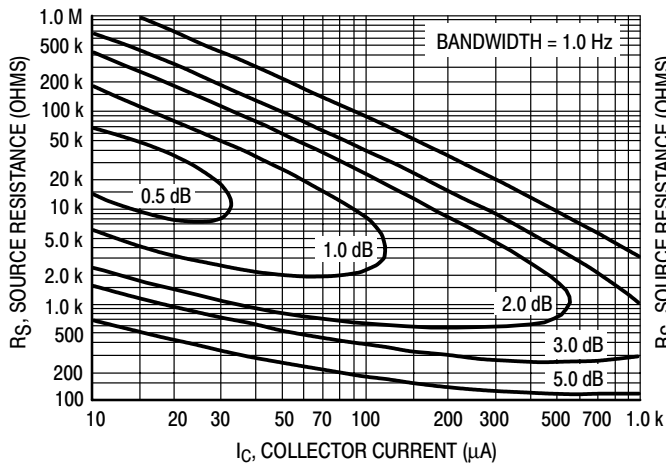

Figure 3. Narrow Band, 100 Hz

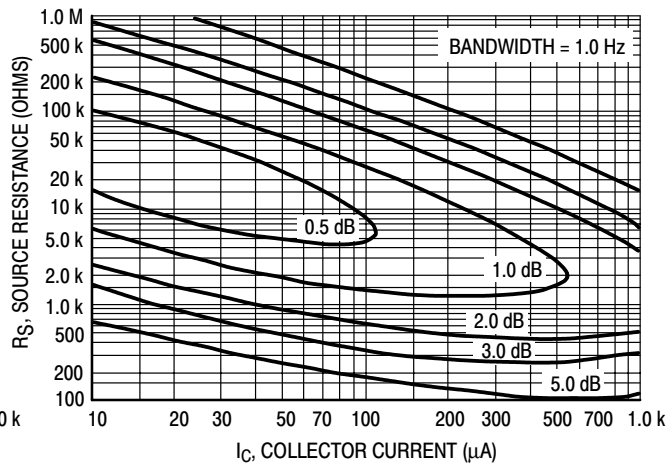

Figure 4. Narrow Band, 1.0 kHz

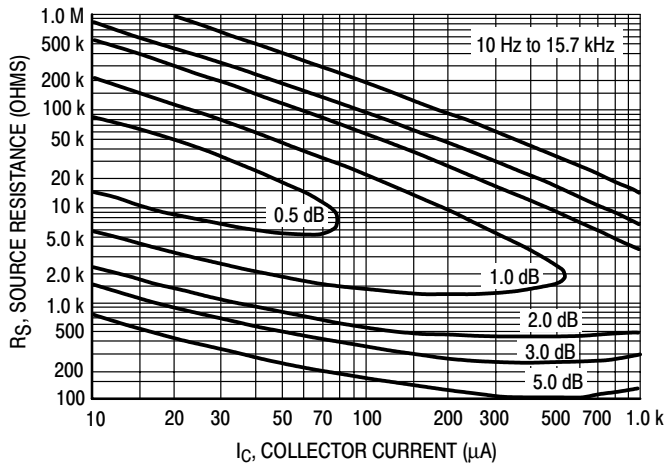

Figure 5. Wideband

Noise Figure is Defined as:

$$NF = 20 \log_{10} \left[\frac{e_n^2 + 4KTR_S + I_n^2 R_S^2}{4KTR_S} \right]^{1/2}$$

e_n = Noise Voltage of the Transistor referred to the input. (Figure 3)

I_n = Noise Current of the Transistor referred to the input. (Figure 4)

K = Boltzman's Constant (1.38×10^{-23} J/ $^\circ\text{K}$)

T = Temperature of the Source Resistance ($^\circ\text{K}$)

R_S = Source Resistance (Ohms)

BCW69LT1 BCW70LT1

TYPICAL STATIC CHARACTERISTICS

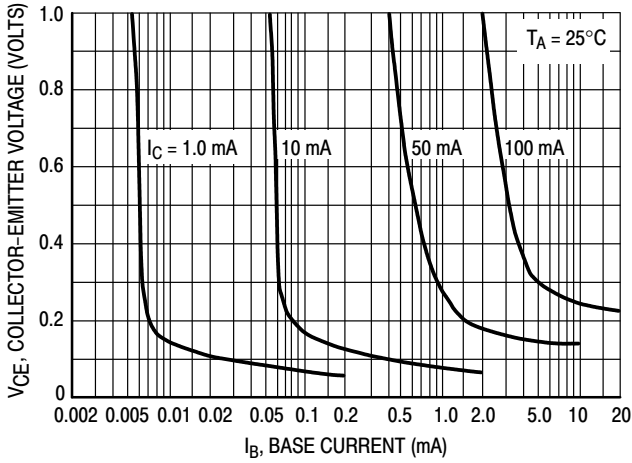

Figure 6. Collector Saturation Region

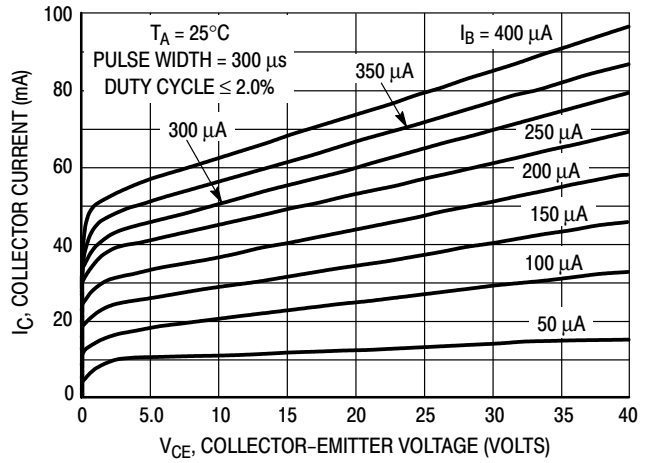

Figure 7. Collector Characteristics

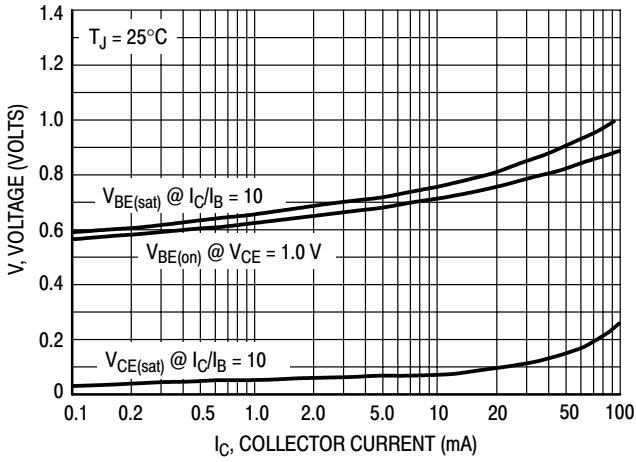

Figure 8. "On" Voltages

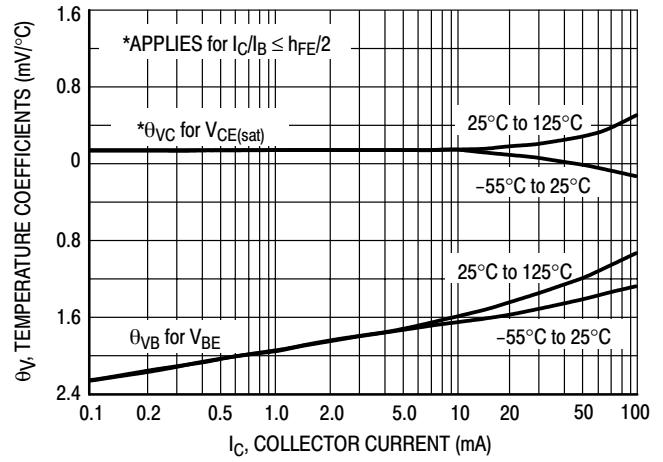

Figure 9. Temperature Coefficients

BCW69LT1 BCW70LT1

TYPICAL DYNAMIC CHARACTERISTICS

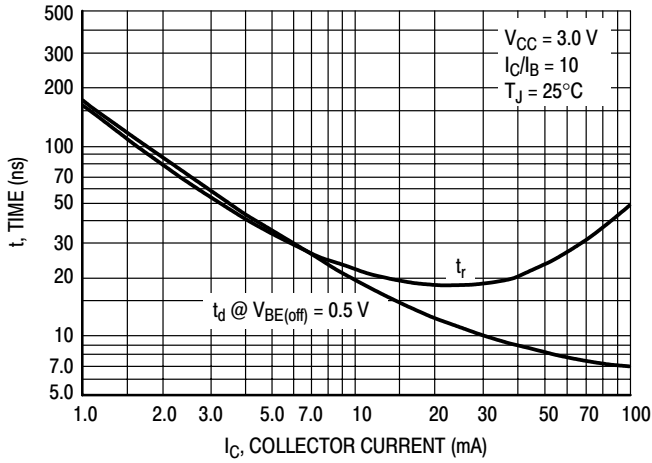

Figure 10. Turn-On Time

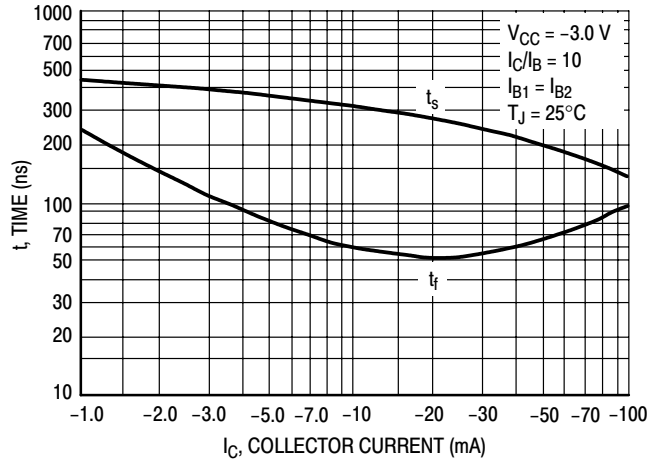

Figure 11. Turn-Off Time

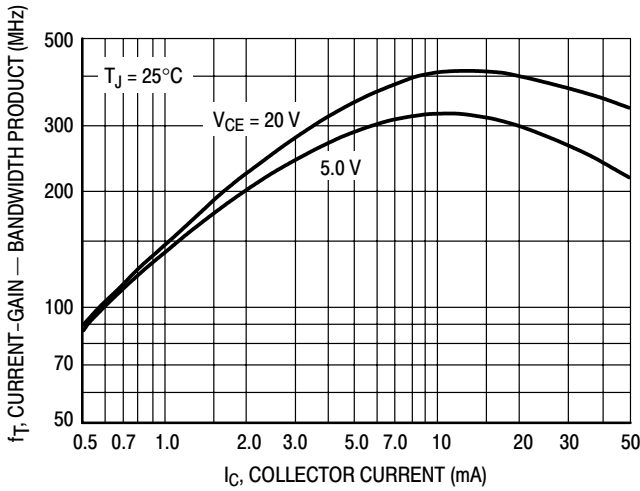

Figure 12. Current-Gain — Bandwidth Product

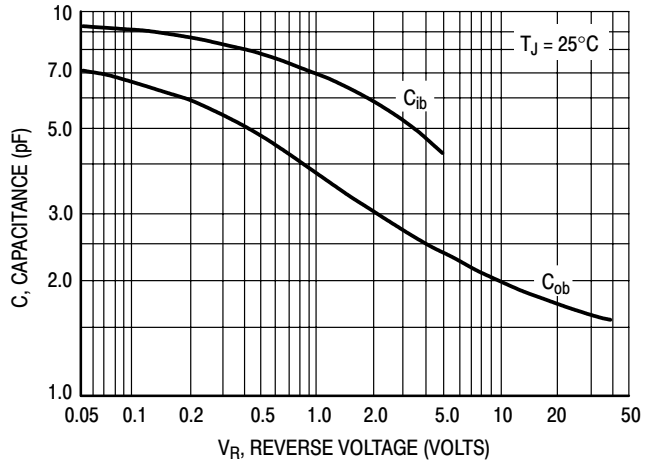

Figure 13. Capacitance

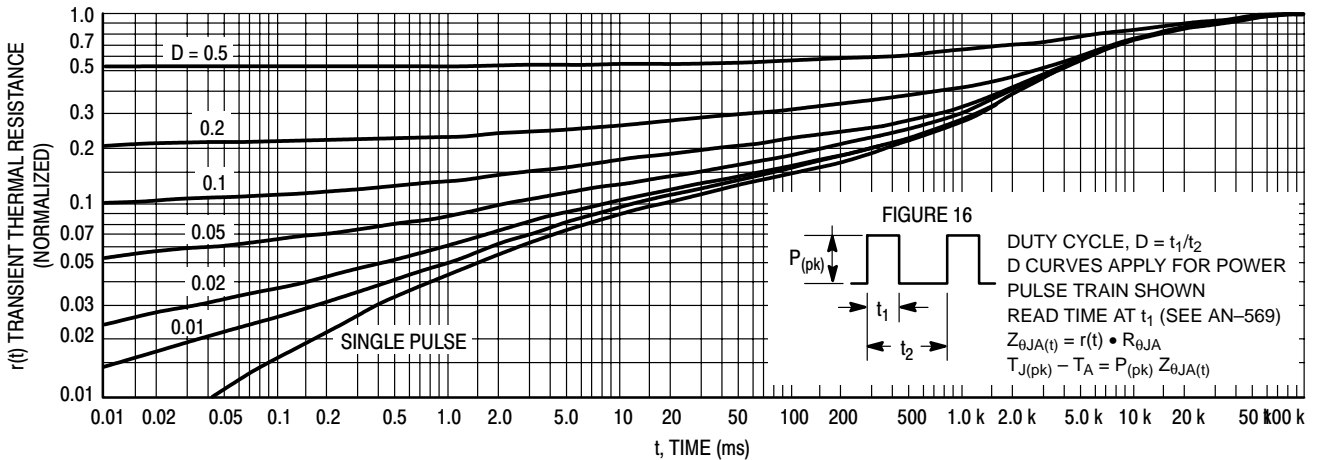

Figure 14. Thermal Response

BCW69LT1 BCW70LT1

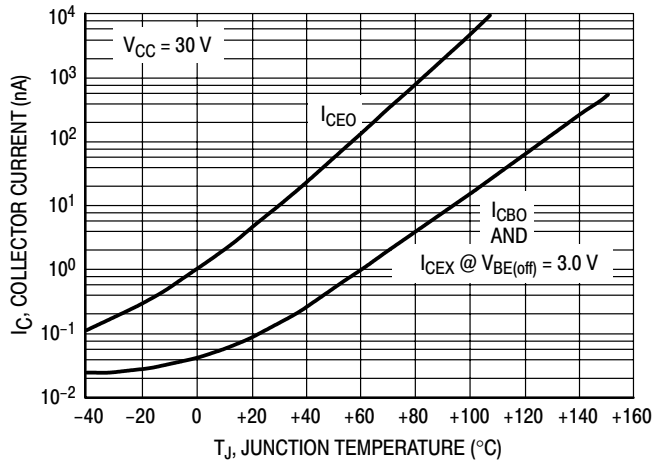

Figure 15. Typical Collector Leakage Current

DESIGN NOTE: USE OF THERMAL RESPONSE DATA

A train of periodical power pulses can be represented by the model as shown in Figure 16. Using the model and the device thermal response the normalized effective transient thermal resistance of Figure 14 was calculated for various duty cycles.

To find $Z_{\theta JA(t)}$, multiply the value obtained from Figure 14 by the steady state value $R_{\theta JA}$.

Example:

Dissipating 2.0 watts peak under the following conditions:

$$t_1 = 1.0\text{ ms}, t_2 = 5.0\text{ ms} (D = 0.2)$$

Using Figure 14 at a pulse width of 1.0 ms and $D = 0.2$, the reading of $r(t)$ is 0.22.

The peak rise in junction temperature is therefore

$$\Delta T = r(t) \times P_{(pk)} \times R_{\theta JA} = 0.22 \times 2.0 \times 200 = 88^{\circ}\text{C}.$$

For more information, see AN-569.

INFORMATION FOR USING THE SOT-23 SURFACE MOUNT PACKAGE

MINIMUM RECOMMENDED FOOTPRINT FOR SURFACE MOUNTED APPLICATIONS

Surface mount board layout is a critical portion of the total design. The footprint for the semiconductor packages must be the correct size to insure proper solder connection

interface between the board and the package. With the correct pad geometry, the packages will self align when subjected to a solder reflow process.

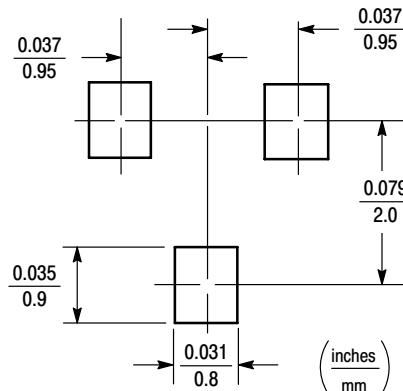

SOT-23

SOT-23 POWER DISSIPATION

The power dissipation of the SOT-23 is a function of the pad size. This can vary from the minimum pad size for soldering to a pad size given for maximum power dissipation. Power dissipation for a surface mount device is determined by $T_{J(max)}$, the maximum rated junction temperature of the die, $R_{\theta JA}$, the thermal resistance from the device junction to ambient, and the operating temperature, T_A . Using the values provided on the data sheet for the SOT-23 package, P_D can be calculated as follows:

$$P_D = \frac{T_{J(max)} - T_A}{R_{\theta JA}}$$

The values for the equation are found in the maximum ratings table on the data sheet. Substituting these values into the equation for an ambient temperature T_A of 25°C, one can calculate the power dissipation of the device which in this case is 225 milliwatts.

$$P_D = \frac{150^\circ\text{C} - 25^\circ\text{C}}{556^\circ\text{C/W}} = 225 \text{ milliwatts}$$

The 556°C/W for the SOT-23 package assumes the use of the recommended footprint on a glass epoxy printed circuit board to achieve a power dissipation of 225 milliwatts. There are other alternatives to achieving higher power dissipation from the SOT-23 package. Another alternative would be to use a ceramic substrate or an aluminum core board such as Thermal Clad™. Using a board material such as Thermal Clad, an aluminum core board, the power dissipation can be doubled using the same footprint.

SOLDERING PRECAUTIONS

The melting temperature of solder is higher than the rated temperature of the device. When the entire device is heated to a high temperature, failure to complete soldering within a short time could result in device failure. Therefore, the following items should always be observed in order to minimize the thermal stress to which the devices are subjected.

- Always preheat the device.
 - The delta temperature between the preheat and soldering should be 100°C or less.*
 - When preheating and soldering, the temperature of the leads and the case must not exceed the maximum temperature ratings as shown on the data sheet. When using infrared heating with the reflow soldering method, the difference shall be a maximum of 10°C.
 - The soldering temperature and time shall not exceed 260°C for more than 10 seconds.
 - When shifting from preheating to soldering, the maximum temperature gradient shall be 5°C or less.
 - After soldering has been completed, the device should be allowed to cool naturally for at least three minutes. Gradual cooling should be used as the use of forced cooling will increase the temperature gradient and result in latent failure due to mechanical stress.
 - Mechanical stress or shock should not be applied during cooling.
- * Soldering a device without preheating can cause excessive thermal shock and stress which can result in damage to the device.

BCW69LT1 BCW70LT1

PACKAGE DIMENSIONS

SOT-23 (TO-236) CASE 318-08 ISSUE AF

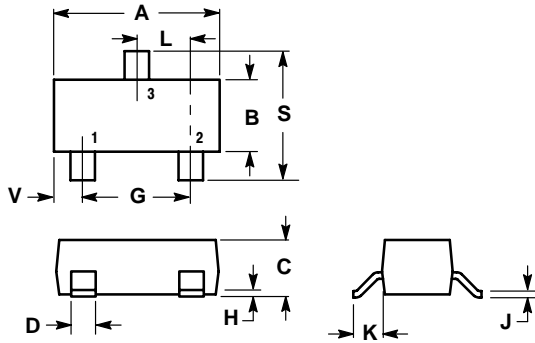

NOTES:

1. DIMENSIONING AND TOLERANCING PER ANSI Y14.5M, 1982.
2. CONTROLLING DIMENSION: INCH.
3. MAXIMUM LEAD THICKNESS INCLUDES LEAD FINISH THICKNESS. MINIMUM LEAD THICKNESS IS THE MINIMUM THICKNESS OF BASE MATERIAL.

DIM	INCHES		MILLIMETERS	
	MIN	MAX	MIN	MAX
A	0.1102	0.1197	2.80	3.04
B	0.0472	0.0551	1.20	1.40
C	0.0350	0.0440	0.89	1.11
D	0.0150	0.0200	0.37	0.50
G	0.0701	0.0807	1.78	2.04
H	0.0005	0.0040	0.013	0.100
J	0.0034	0.0070	0.085	0.177
K	0.0140	0.0285	0.35	0.69
L	0.0350	0.0401	0.89	1.02
S	0.0830	0.1039	2.10	2.64
V	0.0177	0.0236	0.45	0.60

STYLE 6:

1. BASE
2. EMITTER
3. COLLECTOR

Thermal Clad is a trademark of the Bergquist Company

ON Semiconductor and  are trademarks of Semiconductor Components Industries, LLC (SCILLC). SCILLC reserves the right to make changes without further notice to any products herein. SCILLC makes no warranty, representation or guarantee regarding the suitability of its products for any particular purpose, nor does SCILLC assume any liability arising out of the application or use of any product or circuit, and specifically disclaims any and all liability, including without limitation special, consequential or incidental damages. "Typical" parameters which may be provided in SCILLC data sheets and/or specifications can and do vary in different applications and actual performance may vary over time. All operating parameters, including "Typicals" must be validated for each customer application by customer's technical experts. SCILLC does not convey any license under its patent rights nor the rights of others. SCILLC products are not designed, intended, or authorized for use as components in systems intended for surgical implant into the body, or other applications intended to support or sustain life, or for any other application in which the failure of the SCILLC product could create a situation where personal injury or death may occur. Should Buyer purchase or use SCILLC products for any such unintended or unauthorized application, Buyer shall indemnify and hold SCILLC and its officers, employees, subsidiaries, affiliates, and distributors harmless against all claims, costs, damages, and expenses, and reasonable attorney fees arising out of, directly or indirectly, any claim of personal injury or death associated with such unintended or unauthorized use, even if such claim alleges that SCILLC was negligent regarding the design or manufacture of the part. SCILLC is an Equal Opportunity/Affirmative Action Employer.

PUBLICATION ORDERING INFORMATION

NORTH AMERICA Literature Fulfillment:

Literature Distribution Center for ON Semiconductor
P.O. Box 5163, Denver, Colorado 80217 USA
Phone: 303-675-2175 or 800-344-3860 Toll Free USA/Canada
Fax: 303-675-2176 or 800-344-3867 Toll Free USA/Canada
Email: ONlit@hibbertco.com
Fax Response Line: 303-675-2167 or 800-344-3810 Toll Free USA/Canada

N. American Technical Support: 800-282-9855 Toll Free USA/Canada

EUROPE: LDC for ON Semiconductor – European Support

German Phone: (+1) 303-308-7140 (Mon-Fri 2:30pm to 7:00pm CET)
Email: ONlit-german@hibbertco.com
French Phone: (+1) 303-308-7141 (Mon-Fri 2:00pm to 7:00pm CET)
Email: ONlit-french@hibbertco.com
English Phone: (+1) 303-308-7142 (Mon-Fri 12:00pm to 5:00pm GMT)
Email: ONlit@hibbertco.com

EUROPEAN TOLL-FREE ACCESS*: 00-800-4422-3781

*Available from Germany, France, Italy, UK, Ireland

CENTRAL/SOUTH AMERICA:

Spanish Phone: 303-308-7143 (Mon-Fri 8:00am to 5:00pm MST)
Email: ONlit-spanish@hibbertco.com
Toll-Free from Mexico: Dial 01-800-288-2872 for Access –
then Dial 866-297-9322

ASIA/PACIFIC: LDC for ON Semiconductor – Asia Support

Phone: 303-675-2121 (Tue-Fri 9:00am to 1:00pm, Hong Kong Time)
Toll Free from Hong Kong & Singapore:
001-800-4422-3781

Email: ONlit-asia@hibbertco.com

JAPAN: ON Semiconductor, Japan Customer Focus Center

4-32-1 Nishi-Gotanda, Shinagawa-ku, Tokyo, Japan 141-0031
Phone: 81-3-5740-2700
Email: r14525@onsemi.com

ON Semiconductor Website: <http://onsemi.com>

For additional information, please contact your local Sales Representative.



LittleDiode supplies new, hard to find or obsolete electronic components and semiconductors all over the world.

With over two million different components listed you are sure to find the part you need.

Feel free to visit us today at our online store:

LittleDiode.com

Looking forward to providing you with the best possible service.