

**PNP Silicon AF Transistors**

- For AF input stages and driver applications
- High current gain
- Low collector-emitter saturation voltage
- Complementary types: BC847BL3,  
BC848BL3 (NPN)

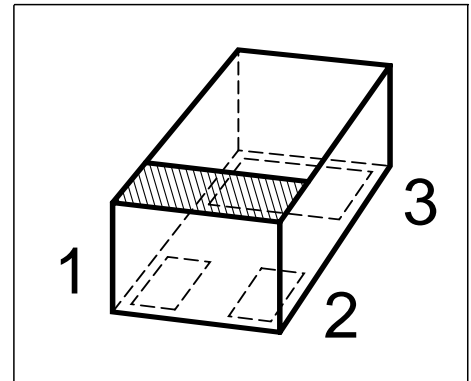

Type	Marking	Pin Configuration			Package
		1 = B	2 = E	3 = C	
BC857BL3	3F	1 = B	2 = E	3 = C	TSLP-3-1
BC858BL3	3K	1 = B	2 = E	3 = C	TSLP-3-1

**Maximum Ratings**

Parameter	Symbol	Value	Unit
Collector-emitter voltage	$V_{CEO}$		V
BC857BL3		45	
BC858BL3		30	
Collector-emitter voltage	$V_{CES}$		
BC857BL3		50	
BC858BL3		30	
Collector-base voltage	$V_{CBO}$		
BC857BL3		50	
BC858BL3		30	
Emitter-base voltage	$V_{EBO}$		
BC857BL3		5	
BC858BL3		5	
Collector current	$I_C$	100	mA
Peak collector current	$I_{CM}$	200	
Total power dissipation $T_S \leq 135^\circ\text{C}$	$P_{tot}$	250	mW
Junction temperature	$T_j$	150	$^\circ\text{C}$
Storage temperature	$T_{stg}$	-65 ... 150	

**Thermal Resistance**

Parameter	Symbol	Value	Unit
Junction - soldering point <sup>1)</sup>	$R_{thJS}$	$\leq 60$	K/W

<sup>1)</sup>For calculation of  $R_{thJA}$  please refer to Application Note Thermal Resistance

**Electrical Characteristics** at  $T_A = 25^\circ\text{C}$ , unless otherwise specified

Parameter	Symbol	Values			Unit
		min.	typ.	max.	
<b>DC Characteristics</b>					
Collector-emitter breakdown voltage $I_C = 10\text{ mA}$ , $I_B = 0$ , BC857BL3 $I_C = 10\text{ mA}$ , $I_B = 0$ , BC858BL3	$V_{(BR)CEO}$	45 30	- -	- -	V
Collector-base breakdown voltage $I_C = 10\ \mu\text{A}$ , $I_E = 0$ , BC857BL3 $I_C = 10\ \mu\text{A}$ , $I_E = 0$ , BC858BL3	$V_{(BR)CBO}$	50 30	- -	- -	
Collector-emitter breakdown voltage $I_C = 10\ \mu\text{A}$ , $V_{BE} = 0$ , BC857BL3 $I_C = 10\ \mu\text{A}$ , $V_{BE} = 0$ , BC858BL3	$V_{(BR)CES}$	50 30	- -	- -	
Emitter-base breakdown voltage $I_E = 0$ , $I_C = 1\ \mu\text{A}$	$V_{(BR)EBO}$	5	-	-	
Collector-base cutoff current $V_{CB} = 30\text{ V}$ , $I_E = 0$ $V_{CB} = 30\text{ V}$ , $I_E = 0$ , $T_A = 150^\circ\text{C}$	$I_{CBO}$	- -	- -	15 5	nA
DC current gain- $I_C = 10\ \mu\text{A}$ , $V_{CE} = 5\text{ V}$ $I_C = 2\text{ mA}$ , $V_{CE} = 5\text{ V}$	$h_{FE}$	- 220	250 290	- 475	-
Collector-emitter saturation voltage <sup>1)</sup> $I_C = 10\text{ mA}$ , $I_B = 0.5\text{ mA}$ $I_C = 100\text{ mA}$ , $I_B = 5\text{ mA}$	$V_{CEsat}$	- -	75 250	300 650	mV
Base emitter saturation voltage- <sup>1)</sup> $I_C = 10\text{ mA}$ , $I_B = 0.5\text{ mA}$ $I_C = 100\text{ mA}$ , $I_B = 5\text{ mA}$	$V_{BEsat}$	- -	700 850	- -	
Base-emitter voltage- <sup>1)</sup> $I_C = 2\text{ mA}$ , $V_{CE} = 5\text{ V}$ $I_C = 10\text{ mA}$ , $V_{CE} = 5\text{ V}$	$V_{BE(ON)}$	600 -	650 -	750 820	

**AC Characteristics**

Transition frequency $I_C = 20 \text{ mA}$ , $V_{CE} = 5 \text{ V}$ , $f = 100 \text{ MHz}$	$f_T$	-	250	-	MHz
Collector-base capacitance $V_{CB} = 10 \text{ V}$ , $f = 1 \text{ MHz}$	$C_{cb}$	-	3	-	pF
Emitter-base capacitance $V_{EB} = 0.5 \text{ V}$ , $f = 1 \text{ MHz}$	$C_{eb}$	-	8	-	
Short-circuit input impedance $I_C = 2 \text{ mA}$ , $V_{CE} = 5 \text{ V}$ , $f = 1 \text{ kHz}$	$h_{11e}$	-	4.5	-	k $\Omega$
Open-circuit reverse voltage transf. ratio $I_C = 2 \text{ mA}$ , $V_{CE} = 5 \text{ V}$ , $f = 1 \text{ kHz}$	$h_{12e}$	-	2	-	$10^{-4}$
Short-circuit forward current transf. ratio $I_C = 2 \text{ mA}$ , $V_{CE} = 5 \text{ V}$ , $f = 1 \text{ kHz}$	$h_{21e}$	-	330	-	-
Open-circuit output admittance $I_C = 2 \text{ mA}$ , $V_{CE} = 5 \text{ V}$ , $f = 1 \text{ kHz}$	$h_{22e}$	-	30	-	$\mu\text{S}$

**DC current gain  $h_{FE} = f(I_C)$**

$V_{CE} = 5\text{ V}$

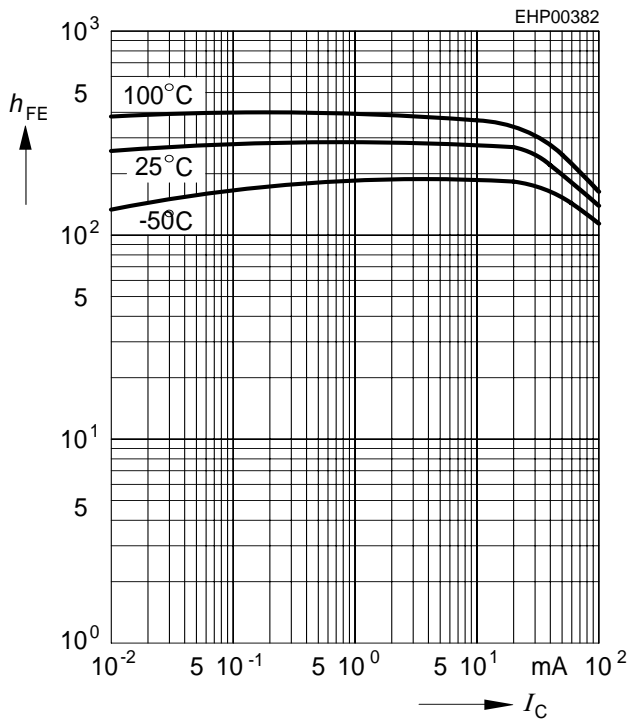

**Collector-emitter saturation voltage**

$I_C = f(V_{CEsat}), h_{FE} = 20$

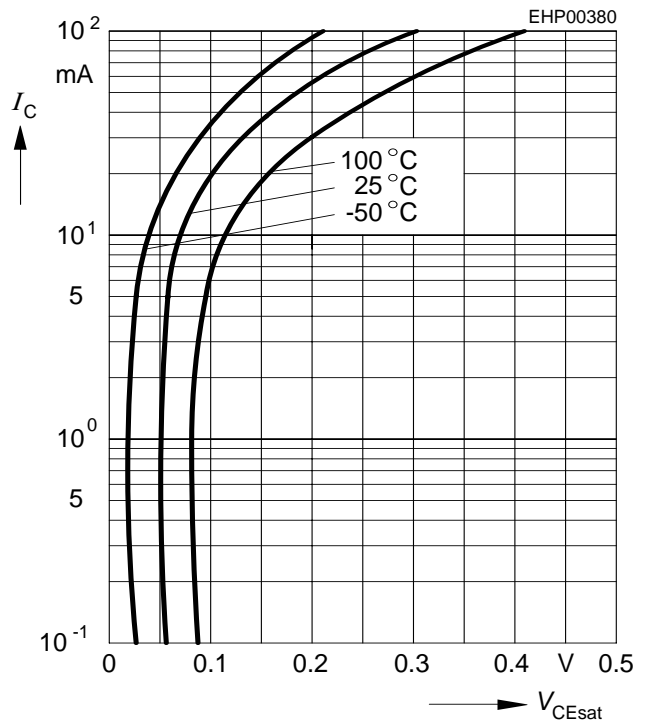

**Base-emitter saturation voltage**

$I_C = f(V_{BEsat}), h_{FE} = 20$

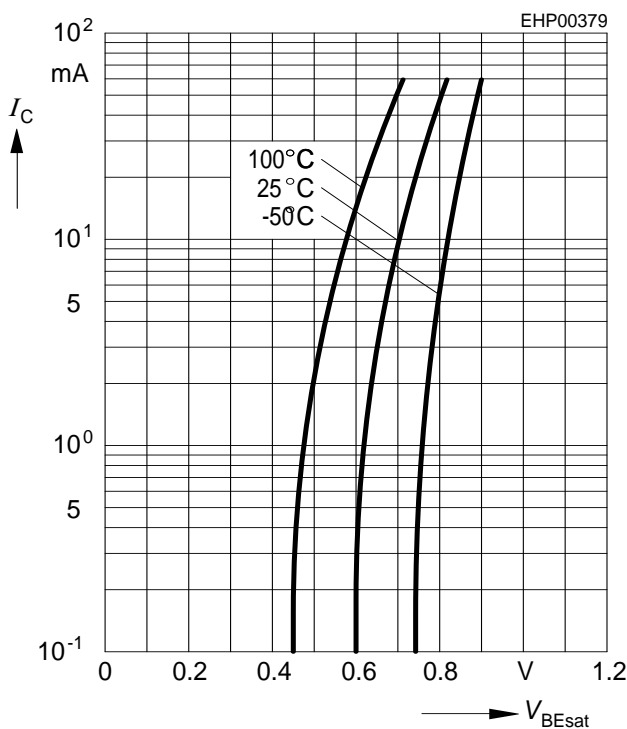

**Collector cutoff current  $I_{CBO} = f(T_A)$**

$V_{CBO} = 30\text{ V}$

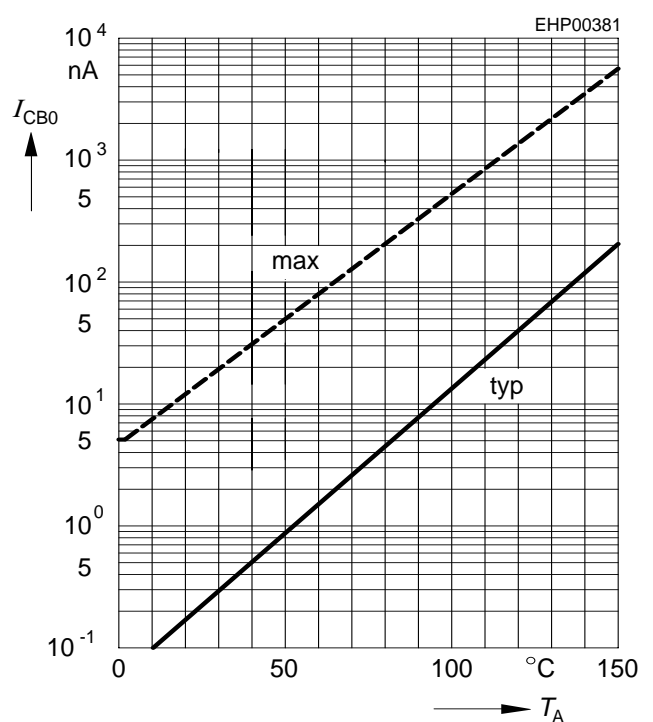

Transition frequency  $f_T = f(I_C)$

$V_{CE} = 5\text{ V}$

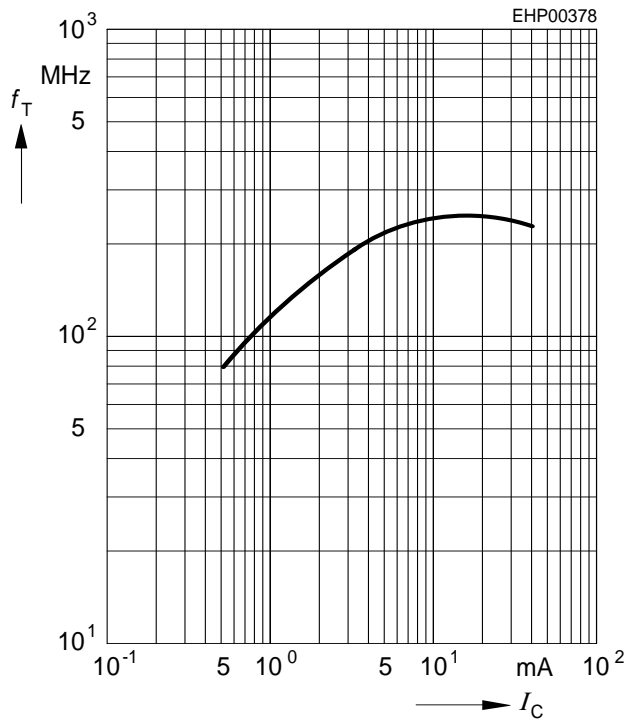

Collector-base capacitance  $C_{CB} = f(V_{CB0})$

Emitter-base capacitance  $C_{EB} = f(V_{EB0})$

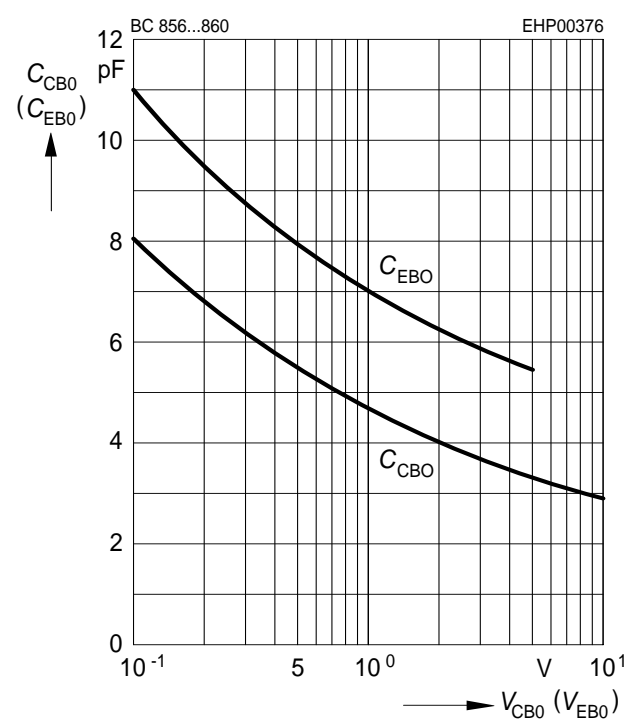

Total power dissipation  $P_{tot} = f(T_S)$

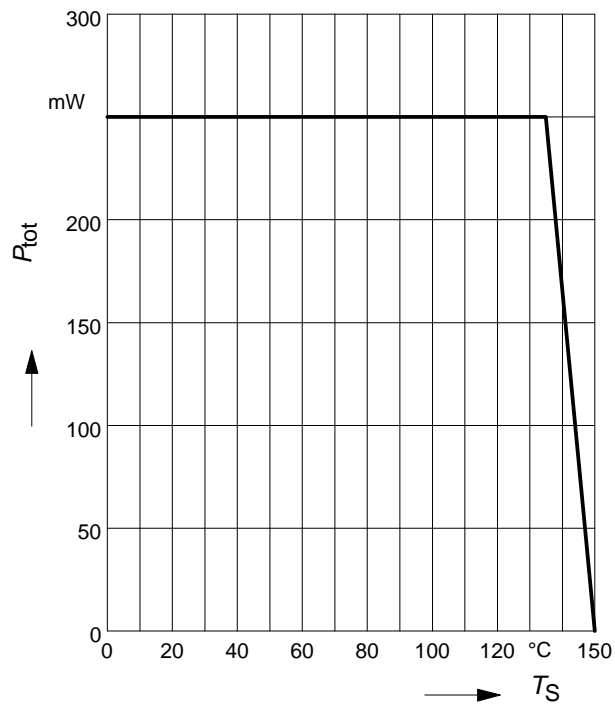

Permissible Pulse Load  $R_{thJS} = f(t_p)$

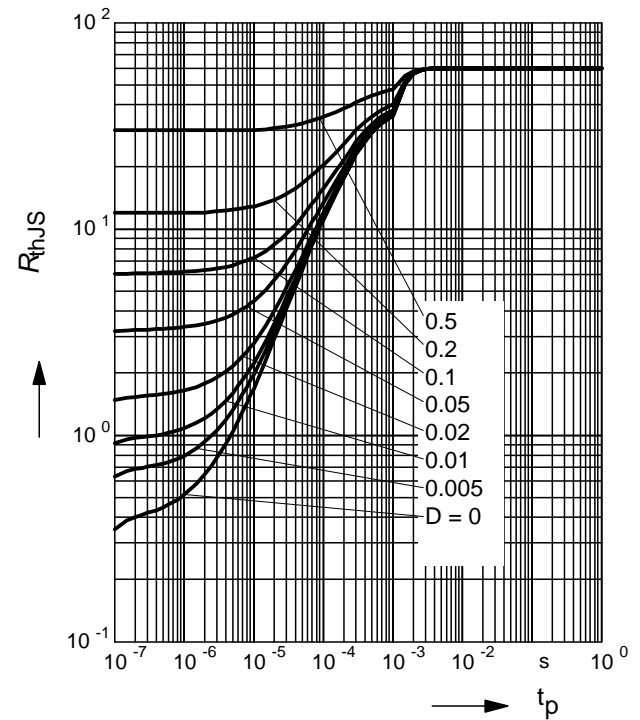

**Permissible Pulse Load**

$$P_{\text{totmax}}/P_{\text{totDC}} = f(t_p)$$

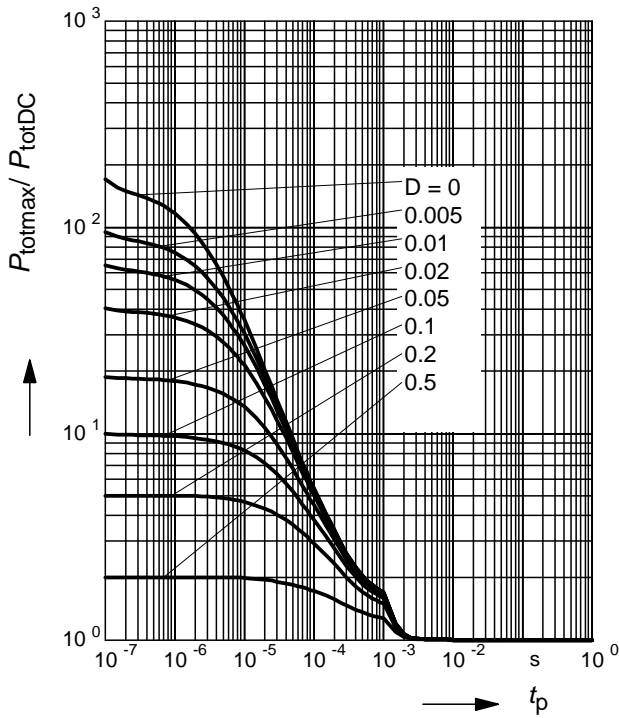

**h parameter  $h_e = f(I_C)$  normalized**

$$V_{\text{CE}} = 5\text{V}$$

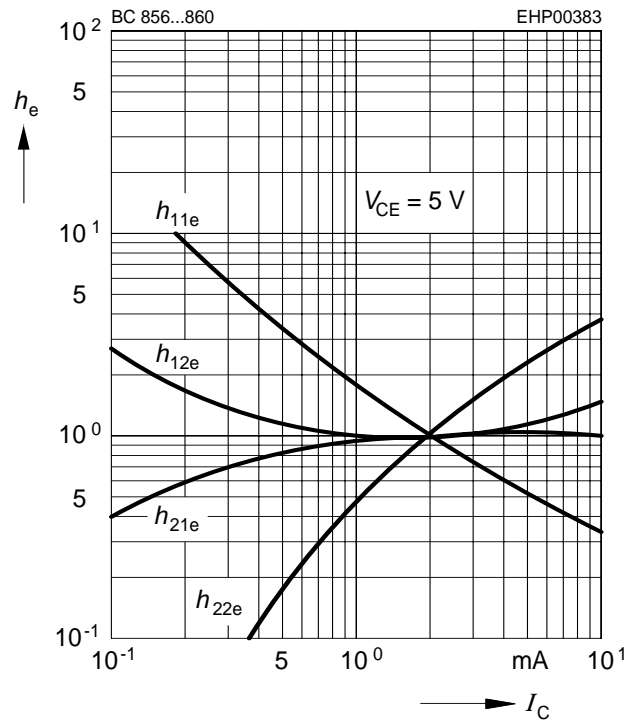

**h parameter  $h_e = f(V_{\text{CE}})$  normalized**

$$I_C = 2\text{mA}$$

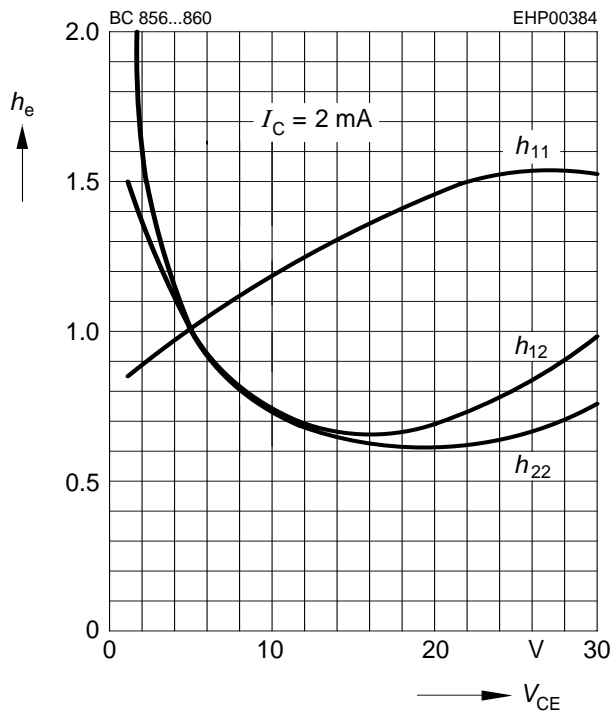

**Published by Infineon Technologies AG,  
St.-Martin-Strasse 53,  
81669 München**

**© Infineon Technologies AG 2004.  
All Rights Reserved.**

**Attention please!**

The information herein is given to describe certain components and shall not be considered as a guarantee of characteristics.

Terms of delivery and rights to technical change reserved.

We hereby disclaim any and all warranties, including but not limited to warranties of non-infringement, regarding circuits, descriptions and charts stated herein.

**Information**

For further information on technology, delivery terms and conditions and prices please contact your nearest Infineon Technologies Office ([www.infineon.com](http://www.infineon.com)).

**Warnings**

Due to technical requirements components may contain dangerous substances. For information on the types in question please contact your nearest Infineon Technologies Office.

Infineon Technologies Components may only be used in life-support devices or systems with the express written approval of Infineon Technologies, if a failure of such components can reasonably be expected to cause the failure of that life-support device or system, or to affect the safety or effectiveness of that device or system. Life support devices or systems are intended to be implanted in the human body, or to support and/or maintain and sustain and/or protect human life. If they fail, it is reasonable to assume that the health of the user or other persons may be endangered.



LittleDiode supplies new, hard to find or obsolete electronic components and semiconductors all over the world.

With over two million different components listed you are sure to find the part you need.

Feel free to visit us today at our online store:

**[LittleDiode.com](http://LittleDiode.com)**

Looking forward to providing you with the best possible service.