

BC847ATT1, BC847BTT1, BC847CTT1

General Purpose Transistors

NPN Silicon

These transistors are designed for general purpose amplifier applications. They are housed in the SC-75/SOT-416 package which is designed for low power surface mount applications.

Features

- Pb-Free Packages are Available*

MAXIMUM RATINGS (T_A = 25°C)

Rating	Symbol	Max	Unit
Collector-Emitter Voltage	V _{CEO}	45	V
Collector-Base Voltage	V _{CBO}	50	V
Emitter-Base Voltage	V _{EBO}	6.0	V
Collector Current – Continuous	I _C	100	mAdc

Maximum ratings are those values beyond which device damage can occur. Maximum ratings applied to the device are individual stress limit values (not normal operating conditions) and are not valid simultaneously. If these limits are exceeded, device functional operation is not implied, damage may occur and reliability may be affected.

THERMAL CHARACTERISTICS

Characteristic	Symbol	Max	Unit
Total Device Dissipation, FR-4 Board (Note 1) T _A = 25°C Derated above 25°C	P _D	200	mW
Thermal Resistance, Junction-to-Ambient (Note 1)	R _{θJA}	600	°C/W
Total Device Dissipation, FR-4 Board (Note 2) T _A = 25°C Derated above 25°C	P _D	300	mW
Thermal Resistance, Junction-to-Ambient (Note 2)	R _{θJA}	400	°C/W
Junction and Storage Temperature Range	T _J , T _{stg}	-55 to +150	°C

- FR-4 @ min pad.
- FR-4 @ 1.0 × 1.0 in pad.

*For additional information on our Pb-Free strategy and soldering details, please download the ON Semiconductor Soldering and Mounting Techniques Reference Manual, SOLDERRM/D.



ON Semiconductor®

<http://onsemi.com>

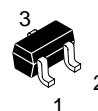
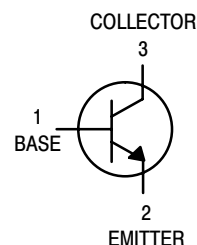

CASE 463
SC-75/SOT-41
6
STYLE 1

MARKING DIAGRAM

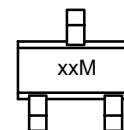

xx = Device Code
M = Date Code

ORDERING INFORMATION

See detailed ordering and shipping information in the package dimensions section on page 5 of this data sheet.

BC847ATT1, BC847BTT1, BC847CTT1

ELECTRICAL CHARACTERISTICS (T_A = 25°C unless otherwise noted)

Characteristic	Symbol	Min	Typ	Max	Unit
OFF CHARACTERISTICS					
Collector–Emitter Breakdown Voltage (I _C = 10 mA)	BC847 Series V _{(BR)CEO}	45	–	–	V
Collector–Emitter Breakdown Voltage (I _C = 10 μA, V _{EB} = 0)	BC847 Series V _{(BR)CES}	50	–	–	V
Collector–Base Breakdown Voltage (I _C = 10 μA)	BC847 Series V _{(BR)CBO}	50	–	–	V
Emitter–Base Breakdown Voltage (I _E = 1.0 μA)	BC847 Series V _{(BR)EBO}	6.0	–	–	V
Collector Cutoff Current (V _{CB} = 30 V) (V _{CB} = 30 V, T _A = 150°C)	I _{CBO}	–	–	15 5.0	nA μA
ON CHARACTERISTICS					
DC Current Gain (I _C = 10 μA, V _{CE} = 5.0 V)	BC847A BC847B BC847C	h _{FE}	–	90 150 270	–
(I _C = 2.0 mA, V _{CE} = 5.0 V)	BC847A BC847B BC847C		110 200 420	180 290 520	220 450 800
Collector–Emitter Saturation Voltage (I _C = 10 mA, I _B = 0.5 mA) (I _C = 100 mA, I _B = 5.0 mA)	V _{CE(sat)}	–	–	0.25 0.6	V
Base–Emitter Saturation Voltage (I _C = 10 mA, I _B = 0.5 mA) (I _C = 100 mA, I _B = 5.0 mA)	V _{BE(sat)}	–	0.7 0.9	–	V
Base–Emitter Voltage (I _C = 2.0 mA, V _{CE} = 5.0 V) (I _C = 10 mA, V _{CE} = 5.0 V)	V _{BE(on)}	580	660	700 770	mV
SMALL–SIGNAL CHARACTERISTICS					
Current–Gain – Bandwidth Product (I _C = 10 mA, V _{CE} = 5.0 Vdc, f = 100 MHz)	f _T	100	–	–	MHz
Output Capacitance (V _{CB} = 10 V, f = 1.0 MHz)	C _{obo}	–	–	4.5	pF
Noise Figure (I _C = 0.2 mA, V _{CE} = 5.0 Vdc, R _S = 2.0 kΩ, f = 1.0 kHz, BW = 200 Hz)	NF	–	–	10	dB

BC847ATT1, BC847BTT1, BC847CTT1

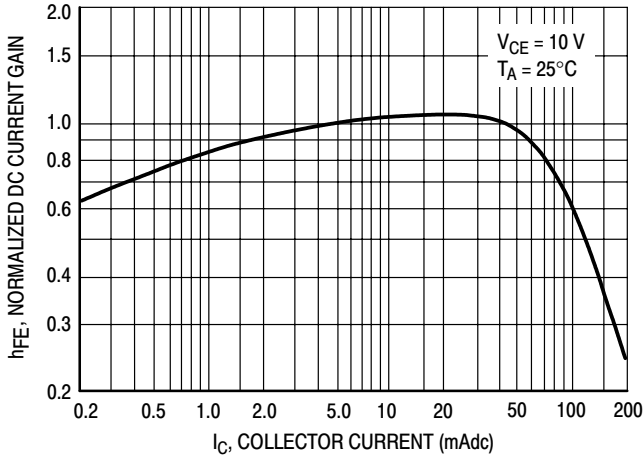

Figure 1. Normalized DC Current Gain

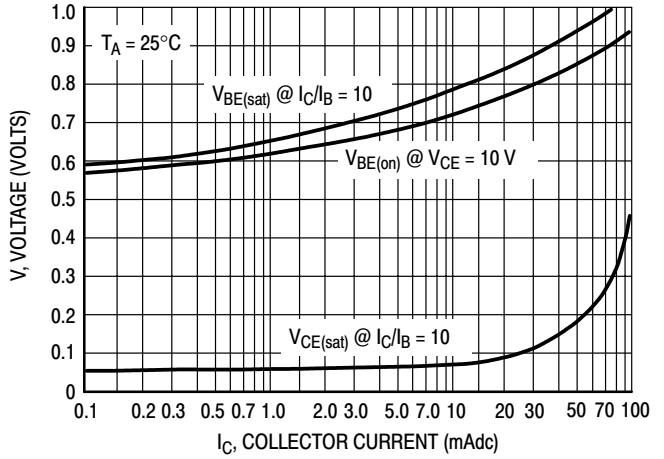

Figure 2. "Saturation" and "On" Voltages

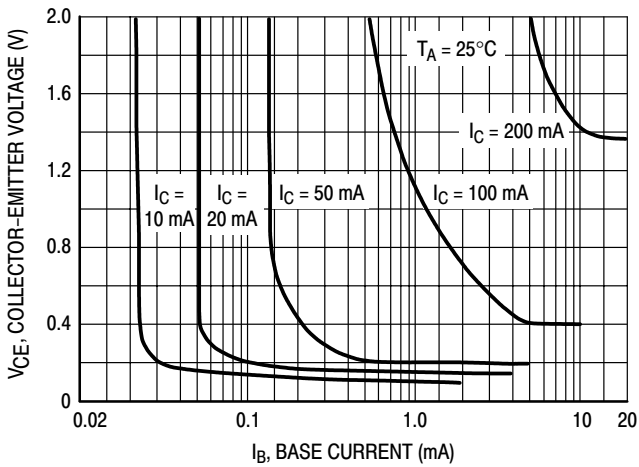

Figure 3. Collector Saturation Region

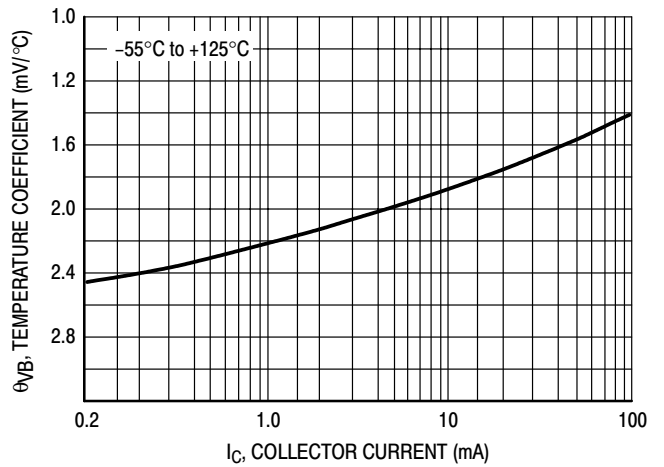

Figure 4. Base-Emitter Temperature Coefficient

BC847ATT1, BC847BTT1, BC847CTT1

BC847

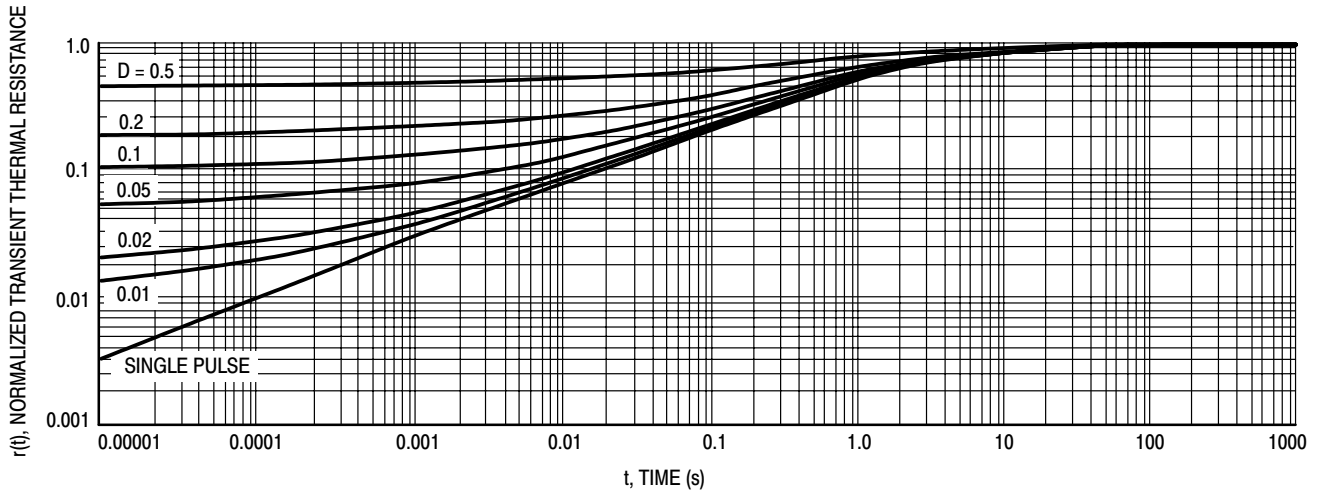

Figure 5. Normalized Thermal Response

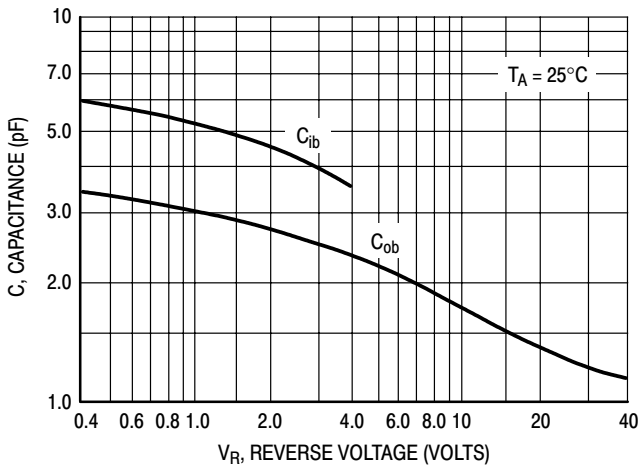

Figure 6. Capacitances

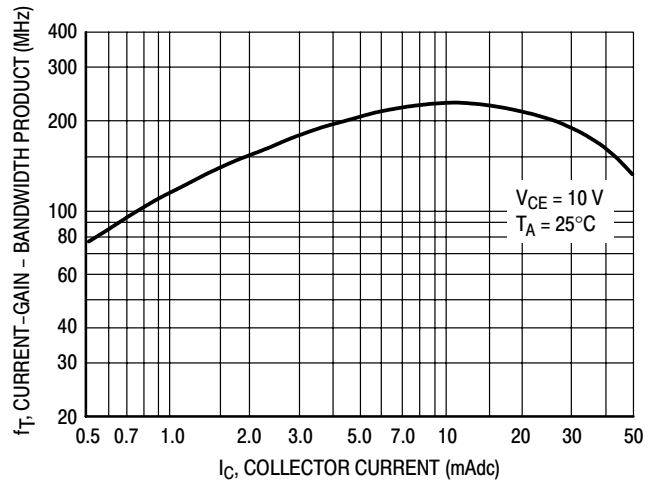

Figure 7. Current-Gain - Bandwidth Product

BC847ATT1, BC847BTT1, BC847CTT1

ORDERING INFORMATION

Device	Marking	Package	Shipping†
BC847ATT1	1E	SC-75/SOT-416	3,000 / Tape & Reel
BC847BTT1	1F	SC-75/SOT-416	3,000 / Tape & Reel
BC847BTT1G	1F	SC-75/SOT-416 (Pb-Free)	
BC847CTT1	1G	SC-75/SOT-416	3,000 / Tape & Reel
BC847CTT1G	1G	SC-75/SOT-416 (Pb-Free)	

†For information on tape and reel specifications, including part orientation and tape sizes, please refer to our Tape and Reel Packaging Specifications Brochure, BRD8011/D.

BC847ATT1, BC847BTT1, BC847CTT1

PACKAGE DIMENSIONS

SC-75/SOT-416
CASE 463-01
ISSUE C

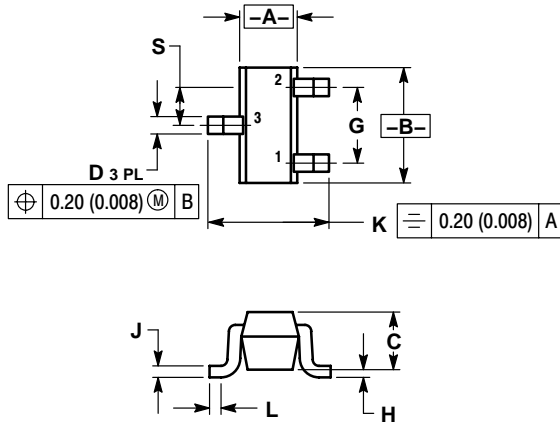

NOTES:

1. DIMENSIONING AND TOLERANCING PER ANSI Y14.5M, 1982.
2. CONTROLLING DIMENSION: MILLIMETER.

DIM	MILLIMETERS		INCHES	
	MIN	MAX	MIN	MAX
A	0.70	0.90	0.028	0.035
B	1.40	1.80	0.055	0.071
C	0.60	0.90	0.024	0.035
D	0.15	0.30	0.006	0.012
G	1.00 BSC		0.039 BSC	
H	---	0.10	---	0.004
J	0.10	0.25	0.004	0.010
K	1.45	1.75	0.057	0.069
L	0.10	0.20	0.004	0.008
S	0.50 BSC		0.020 BSC	

ON Semiconductor and  are registered trademarks of Semiconductor Components Industries, LLC (SCILLC). SCILLC reserves the right to make changes without further notice to any products herein. SCILLC makes no warranty, representation or guarantee regarding the suitability of its products for any particular purpose, nor does SCILLC assume any liability arising out of the application or use of any product or circuit, and specifically disclaims any and all liability, including without limitation special, consequential or incidental damages. "Typical" parameters which may be provided in SCILLC data sheets and/or specifications can and do vary in different applications and actual performance may vary over time. All operating parameters, including "Typicals" must be validated for each customer application by customer's technical experts. SCILLC does not convey any license under its patent rights nor the rights of others. SCILLC products are not designed, intended, or authorized for use as components in systems intended for surgical implant into the body, or other applications intended to support or sustain life, or for any other application in which the failure of the SCILLC product could create a situation where personal injury or death may occur. Should Buyer purchase or use SCILLC products for any such unintended or unauthorized application, Buyer shall indemnify and hold SCILLC and its officers, employees, subsidiaries, affiliates, and distributors harmless against all claims, costs, damages, and expenses, and reasonable attorney fees arising out of, directly or indirectly, any claim of personal injury or death associated with such unintended or unauthorized use, even if such claim alleges that SCILLC was negligent regarding the design or manufacture of the part. SCILLC is an Equal Opportunity/Affirmative Action Employer. This literature is subject to all applicable copyright laws and is not for resale in any manner.

PUBLICATION ORDERING INFORMATION

LITERATURE FULFILLMENT:

Literature Distribution Center for ON Semiconductor
P.O. Box 61312, Phoenix, Arizona 85082-1312 USA
Phone: 480-829-7710 or 800-344-3860 Toll Free USA/Canada
Fax: 480-829-7709 or 800-344-3867 Toll Free USA/Canada
Email: orderlit@onsemi.com

N. American Technical Support: 800-282-9855 Toll Free
USA/Canada

Japan: ON Semiconductor, Japan Customer Focus Center
2-9-1 Kamimeguro, Meguro-ku, Tokyo, Japan 153-0051
Phone: 81-3-5773-3850

ON Semiconductor Website: <http://onsemi.com>

Order Literature: <http://www.onsemi.com/litorder>

For additional information, please contact your local Sales Representative.



LittleDiode supplies new, hard to find or obsolete electronic components and semiconductors all over the world.

With over two million different components listed you are sure to find the part you need.

Feel free to visit us today at our online store:

LittleDiode.com

Looking forward to providing you with the best possible service.