

# AN80LxxRMS Series

Positive output, low dropout voltage regulator (150 mA type)

## ■ Overview

The AN80LxxRMS series is a 0.15 A, low dropout, positive voltage regulator with reset function. 20 classifications of output voltages, 1.8 V, 1.9 V, 2.0 V, 2.1 V, 2.2 V, 2.5 V, 2.8 V, 2.9 V, 3.0 V, 3.1 V, 3.2 V, 3.3 V, 3.4 V, 3.5 V, 3.6 V, 4.8 V, 4.9 V, 5.0 V, 5.1 V and 5.2 V are available. In addition, it is adopting the surface mounting type package, so that it is most suited for miniaturization and weight reduction of set equipment.

## ■ Features

- Minimum input and output voltage difference: 0.4 V max.
- High accuracy output voltage: (allowance:  $\pm 3\%$ )
- Built-in reset function terminal (high: active)
- Built-in overcurrent limit circuit
- Built-in rush current prevention circuit at input voltage rise
- Output voltage: 1.8 V to 5.2 V

## ■ Applications

- Cellular phone, PHS, analog cordless phone, other small sized portable equipment

## ■ Block Diagram

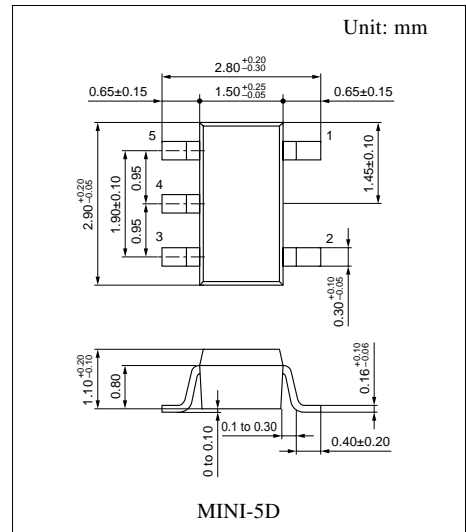
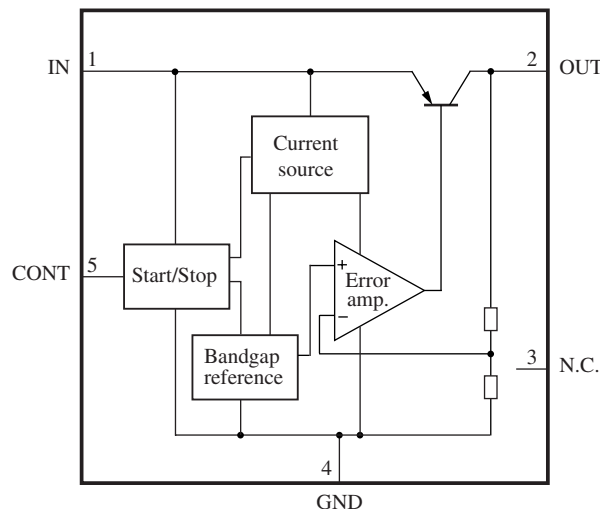

On marking, see page 2

**■ Output Voltage Characteristics at  $I_{OUT} = 50 \text{ mA}$ ,  $T_a = 25^\circ\text{C}$** 

Type No.	Output V	Conditions	Min	Type	Max	Unit	Marking
AN80L18RMS	1.8	$V_{IN} = 2.8 \text{ V}$	1.746	1.8	1.854	V	BA
AN80L19RMS	1.9	2.9	1.843	1.9	1.957	V	BB
AN80L20RMS	2.0	3.0	1.940	2.0	2.060	V	BC
AN80L21RMS	2.1	3.1	2.037	2.1	2.163	V	BD
AN80L22RMS	2.2	3.2	2.134	2.2	2.266	V	BE
AN80L25RMS	2.5	3.5	2.425	2.5	2.575	V	BW
AN80L28RMS	2.8	3.8	2.716	2.8	2.884	V	BF
AN80L29RMS	2.9	3.9	2.813	2.9	2.987	V	BG
AN80L30RMS	3.0	4.0	2.910	3.0	3.090	V	BH
AN80L31RMS	3.1	4.1	3.007	3.1	3.193	V	BJ
AN80L32RMS	3.2	4.2	3.104	3.2	3.296	V	BK
AN80L33RMS	3.3	4.3	3.201	3.3	3.399	V	BL
AN80L34RMS	3.4	4.4	3.298	3.4	3.502	V	BM
AN80L35RMS	3.5	4.5	3.395	3.5	3.605	V	BN
AN80L36RMS	3.6	4.6	3.492	3.6	3.708	V	BP
AN80L48RMS	4.8	5.8	4.656	4.8	4.944	V	BQ
AN80L49RMS	4.9	5.9	4.753	4.9	5.047	V	BR
AN80L50RMS	5.0	6.0	4.850	5.0	5.150	V	BS
AN80L51RMS	5.1	6.1	4.947	5.1	5.253	V	BT
AN80L52RMS	5.2	6.2	5.044	5.2	5.356	V	BU

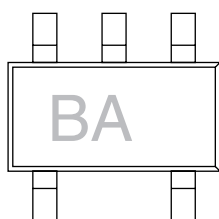

(Marking example: AN80L18RMS)

**■ Pin Descriptions**

Pin No.	Description
1	Input voltage pin
2	Output voltage pin
3	N.C. pin
4	Grounding pin
5	Control pin (High → operation, Low → stop)

### ■ Absolute Maximum Ratings

Parameter	Symbol	Rating	Unit
Supply voltage <sup>*1</sup>	V <sub>CC</sub>	14.6	V
Supply current	I <sub>CC</sub>	300	mA
Power dissipation <sup>*3</sup>	P <sub>D</sub>	78	mW
Operating ambient temperature <sup>*2</sup>	T <sub>opr</sub>	-30 to +85	°C
Storage temperature <sup>*2</sup>	T <sub>stg</sub>	-55 to +150	°C

Note) \*1: There may be a case of the device destruction when the output (V<sub>OUT</sub>) and the grounding (GND), or the output (V<sub>OUT</sub>) and input (V<sub>IN</sub>) are short-circuited.

\*2: Except for the operating ambient temperature and storage temperature, all ratings are for T<sub>a</sub> = 25°C.

\*3: T<sub>opr</sub> = Power dissipation for IC alone without heat sink at +85°C.

### ■ Recommended Operating Conditions

Part No.	Output voltage	Operating supply voltage range (V <sub>CC</sub> )	Unit
AN80L18RMS	1.8	2.2 to 14.5	V
AN80L19RMS	1.9	2.3 to 14.5	V
AN80L20RMS	2.0	2.4 to 14.5	V
AN80L21RMS	2.1	2.5 to 14.5	V
AN80L22RMS	2.2	2.6 to 14.5	V
AN80L25RMS	2.5	2.9 to 14.5	V
AN80L28RMS	2.8	3.2 to 14.5	V
AN80L29RMS	2.9	3.3 to 14.5	V
AN80L30RMS	3.0	3.4 to 14.5	V
AN80L31RMS	3.1	3.5 to 14.5	V
AN80L32RMS	3.2	3.6 to 14.5	V
AN80L33RMS	3.3	3.7 to 14.5	V
AN80L34RMS	3.4	3.8 to 14.5	V
AN80L35RMS	3.5	3.9 to 14.5	V
AN80L36RMS	3.6	4.0 to 14.5	V
AN80L48RMS	4.8	5.2 to 14.5	V
AN80L49RMS	4.9	5.3 to 14.5	V
AN80L50RMS	5.0	5.4 to 14.5	V
AN80L51RMS	5.1	5.5 to 14.5	V
AN80L52RMS	5.2	5.6 to 14.5	V

### ■ Electrical Characteristics at $T_a = 25^\circ\text{C}$

#### • AN80L18RMS (1.8 V type)

Unless otherwise specially provided, shorten each test time (within 10 ms) so that the test is conducted under the condition that the drift due to the temperature increase in the chip junction part can be neglected.  $C_{IN} = 0.1 \mu\text{F}$ ,  $C_{OUT} = 10 \mu\text{F}$

Parameter	Symbol	Conditions	Min	Typ	Max	Unit
Output voltage	$V_{OUT}$	$V_{IN} = 2.8 \text{ V}$ , $I_{OUT} = 50 \text{ mA}$	1.746	1.8	1.854	V
Line regulation 1	$REG_{IN1}$	$V_{IN} = 2.8 \text{ V} \rightarrow 14.5 \text{ V}$ , $I_{OUT} = 50 \text{ mA}$	—	10	50	mV
Line regulation 2	$REG_{IN2}$	$V_{IN} = 2.8 \text{ V} \rightarrow 9 \text{ V}$ , $I_{OUT} = 50 \text{ mA}$	—	5	20	mV
Load regulation *1	$REG_{LOA}$	$V_{IN} = 2.8 \text{ V}$ , $I_{OUT} = 0 \text{ mA} \rightarrow 150 \text{ mA}$	—	50	150	mV
Peak output current *2	$I_{PEAK}$	$V_{IN} = 2.8 \text{ V}$ , The output current value when $V_{OUT}$ decreases by 5% from its value at $I_{OUT} = 50 \text{ mA}$ .	180	240	—	mA
Bias current under no load	$I_{BIAS}$	$V_{IN} = 2.8 \text{ V}$ , $I_{OUT} = 0 \text{ mA}$	—	—	350	$\mu\text{A}$
Bias current fluctuation to load	$\Delta I_{BIAS}$	$V_{IN} = 2.8 \text{ V}$ , $I_{OUT} = 0 \text{ mA} \rightarrow 150 \text{ mA}$	—	—	5	mA
Standby consumption current	$I_{STB}$	$V_{IN} = 10 \text{ V}$ , $V_{CONT} = 0 \text{ V}$	—	—	0.1	$\mu\text{A}$
Bias current before starting regulation	$I_{RUSH}$	$V_{IN} = 1.5 \text{ V}$ , $I_{OUT} = 0 \text{ mA}$	—	1.5	5	mA
Ripple rejection ratio	RR	1 V[rms], $f = 120 \text{ Hz}$ , $I_{OUT} = 10 \text{ mA}$	62	70	—	dB
Minimum input/output voltage difference 1	$V_{DIF(min)1}$	$V_{IN} = 1.5 \text{ V}$ , $I_{OUT} = 0 \text{ mA}$	—	0.1	0.2	V
Minimum input/output voltage difference 2	$V_{DIF(min)2}$	$V_{IN} = 2.1 \text{ V}$ , $I_{OUT} = 150 \text{ mA}$	—	—	0.4	V
Control terminal threshold high voltage	$V_{CONTH}$	$V_{IN} = 2.8 \text{ V}$ , $I_{OUT} = 50 \text{ mA}$	—	—	1.50	V
Control terminal threshold low voltage	$V_{CONTL}$	$V_{IN} = 2.8 \text{ V}$ , $I_{OUT} = 50 \text{ mA}$	0.30	—	—	V
Control terminal current	$I_{CONT}$	$V_{IN} = 2.8 \text{ V}$ , $I_{OUT} = 50 \text{ mA}$ $V_{CONT} = 1.8 \text{ V}$	—	—	30	$\mu\text{A}$

Note) \*1:  $1.0 \Omega$

\*2: Peak output current: The output current when the output voltage has been decreased by 5% from the value at the time when the output current is 50 mA due to the overcurrent protection.

#### • Design reference data

Note) The following values are typical and not guaranteed values.

Parameter	Symbol	Conditions	Min	Typ	Max	Unit
Output noise voltage	$V_{NO}$	$10 \text{ Hz} \leq f \leq 100 \text{ kHz}$ , $I_{OUT} = 10 \text{ mA}$	—	38	—	$\mu\text{V}$
Output voltage temperature coefficient	$\frac{1}{V_{OUT}} \cdot \frac{dV_{OUT}}{dT}$	$V_{IN} = 2.8 \text{ V}$ , $I_{OUT} = 0 \text{ mA}$ $-30^\circ\text{C} \leq T_a \leq +85^\circ\text{C}$	—	90	—	ppm/ $^\circ\text{C}$
Output rise time *	$t_{ON}$	$V_{IN} = 2.8 \text{ V}$ , $I_{OUT} = 50 \text{ mA}$ $V_{CONT} = 0 \text{ V} \rightarrow 1.8 \text{ V}$ , $C_{IN} = 0.1 \mu\text{F}$ $C_{OUT} = 10 \mu\text{F}$ , $V_{OUT} = 90\%$	—	0.10	—	ms

Note) \*: Refer to "■ Application Notes 3. Output rise-time characteristics".

### ■ Electrical Characteristics at $T_a = 25^\circ\text{C}$ (continued)

#### • AN80L19RMS (1.9 V type)

Unless otherwise specially provided, shorten each test time (within 10 ms) so that the test is conducted under the condition that the drift due to the temperature increase in the chip junction part can be neglected.  $C_{IN} = 0.1 \mu\text{F}$ ,  $C_{OUT} = 10 \mu\text{F}$

Parameter	Symbol	Conditions	Min	Typ	Max	Unit
Output voltage	$V_{OUT}$	$V_{IN} = 2.9 \text{ V}$ , $I_{OUT} = 50 \text{ mA}$	1.843	1.9	1.957	V
Line regulation 1	$REG_{IN1}$	$V_{IN} = 2.9 \text{ V} \rightarrow 14.5 \text{ V}$ , $I_{OUT} = 50 \text{ mA}$	—	10	50	mV
Line regulation 2	$REG_{IN2}$	$V_{IN} = 2.9 \text{ V} \rightarrow 9 \text{ V}$ , $I_{OUT} = 50 \text{ mA}$	—	5	20	mV
Load regulation *1	$REG_{LOA}$	$V_{IN} = 2.9 \text{ V}$ , $I_{OUT} = 0 \text{ mA} \rightarrow 150 \text{ mA}$	—	50	150	mV
Peak output current *2	$I_{PEAK}$	$V_{IN} = 2.9 \text{ V}$ , The output current value when $V_{OUT}$ decreases by 5% from its value at $I_{OUT} = 50 \text{ mA}$ .	180	240	—	mA
Bias current under no load	$I_{BIAS}$	$V_{IN} = 2.9 \text{ V}$ , $I_{OUT} = 0 \text{ mA}$	—	—	350	$\mu\text{A}$
Bias current fluctuation to load	$\Delta I_{BIAS}$	$V_{IN} = 2.9 \text{ V}$ , $I_{OUT} = 0 \text{ mA} \rightarrow 150 \text{ mA}$	—	—	5	mA
Standby consumption current	$I_{STB}$	$V_{IN} = 10 \text{ V}$ , $V_{CONT} = 0 \text{ V}$	—	—	0.1	$\mu\text{A}$
Bias current before starting regulation	$I_{RUSH}$	$V_{IN} = 1.6 \text{ V}$ , $I_{OUT} = 0 \text{ mA}$	—	1.5	5	mA
Ripple rejection ratio	RR	1 V[rms], $f = 120 \text{ Hz}$ , $I_{OUT} = 10 \text{ mA}$	62	70	—	dB
Minimum input/output voltage difference 1	$V_{DIF(min)1}$	$V_{IN} = 1.6 \text{ V}$ , $I_{OUT} = 0 \text{ mA}$	—	0.1	0.2	V
Minimum input/output voltage difference 2	$V_{DIF(min)2}$	$V_{IN} = 2.2 \text{ V}$ , $I_{OUT} = 150 \text{ mA}$	—	—	0.4	V
Control terminal threshold high voltage	$V_{CONTH}$	$V_{IN} = 2.9 \text{ V}$ , $I_{OUT} = 50 \text{ mA}$	—	—	1.50	V
Control terminal threshold low voltage	$V_{CONTL}$	$V_{IN} = 2.9 \text{ V}$ , $I_{OUT} = 50 \text{ mA}$	0.30	—	—	V
Control terminal current	$I_{CONT}$	$V_{IN} = 2.9 \text{ V}$ , $I_{OUT} = 50 \text{ mA}$ $V_{CONT} = 1.8 \text{ V}$	—	—	30	$\mu\text{A}$

Note) \*1:  $1.0 \Omega$

\*2: Peak output current: The output current when the output voltage has been decreased by 5% from the value at the time when the output current is 50 mA due to the overcurrent protection.

#### • Design reference data

Note) The following values are typical and not guaranteed values.

Parameter	Symbol	Conditions	Min	Typ	Max	Unit
Output noise voltage	$V_{NO}$	$10 \text{ Hz} \leq f \leq 100 \text{ kHz}$ , $I_{OUT} = 10 \text{ mA}$	—	40	—	$\mu\text{V}$
Output voltage temperature coefficient	$\frac{1}{V_{OUT}} \cdot \frac{dV_{OUT}}{dT}$	$V_{IN} = 2.9 \text{ V}$ , $I_{OUT} = 0 \text{ mA}$ $-30^\circ\text{C} \leq T_a \leq +85^\circ\text{C}$	—	90	—	ppm/ $^\circ\text{C}$
Output rise time *	$t_{ON}$	$V_{IN} = 2.9 \text{ V}$ , $I_{OUT} = 50 \text{ mA}$ $V_{CONT} = 0 \text{ V} \rightarrow 1.8 \text{ V}$ , $C_{IN} = 0.1 \mu\text{F}$ $C_{OUT} = 10 \mu\text{F}$ , $V_{OUT} = 90\%$	—	0.10	—	ms

Note) \*: Refer to "■ Application Notes 3. Output rise-time characteristics".

### ■ Electrical Characteristics at $T_a = 25^\circ\text{C}$ (continued)

#### • AN80L20RMS (2.0 V type)

Unless otherwise specially provided, shorten each test time (within 10 ms) so that the test is conducted under the condition that the drift due to the temperature increase in the chip junction part can be neglected.  $C_{IN} = 0.1 \mu\text{F}$ ,  $C_{OUT} = 10 \mu\text{F}$

Parameter	Symbol	Conditions	Min	Typ	Max	Unit
Output voltage	$V_{OUT}$	$V_{IN} = 3.0 \text{ V}$ , $I_{OUT} = 50 \text{ mA}$	1.940	2.0	2.060	V
Line regulation 1	$REG_{IN1}$	$V_{IN} = 3.0 \text{ V} \rightarrow 14.5 \text{ V}$ , $I_{OUT} = 50 \text{ mA}$	—	10	50	mV
Line regulation 2	$REG_{IN2}$	$V_{IN} = 3.0 \text{ V} \rightarrow 9 \text{ V}$ , $I_{OUT} = 50 \text{ mA}$	—	5	20	mV
Load regulation *1	$REG_{LOA}$	$V_{IN} = 3.0 \text{ V}$ , $I_{OUT} = 0 \text{ mA} \rightarrow 150 \text{ mA}$	—	50	150	mV
Peak output current *2	$I_{PEAK}$	$V_{IN} = 3.0 \text{ V}$ , The output current value when $V_{OUT}$ decreases by 5% from its value at $I_{OUT} = 50 \text{ mA}$ .	180	240	—	mA
Bias current under no load	$I_{BIAS}$	$V_{IN} = 3.0 \text{ V}$ , $I_{OUT} = 0 \text{ mA}$	—	—	350	$\mu\text{A}$
Bias current fluctuation to load	$\Delta I_{BIAS}$	$V_{IN} = 3.0 \text{ V}$ , $I_{OUT} = 0 \text{ mA} \rightarrow 150 \text{ mA}$	—	—	5	mA
Standby consumption current	$I_{STB}$	$V_{IN} = 10 \text{ V}$ , $V_{CONT} = 0 \text{ V}$	—	—	0.1	$\mu\text{A}$
Bias current before starting regulation	$I_{RUSH}$	$V_{IN} = 1.7 \text{ V}$ , $I_{OUT} = 0 \text{ mA}$	—	1.5	5	mA
Ripple rejection ratio	RR	1 V[rms], $f = 120 \text{ Hz}$ , $I_{OUT} = 10 \text{ mA}$	62	70	—	dB
Minimum input/output voltage difference 1	$V_{DIF(min)1}$	$V_{IN} = 1.7 \text{ V}$ , $I_{OUT} = 0 \text{ mA}$	—	0.1	0.2	V
Minimum input/output voltage difference 2	$V_{DIF(min)2}$	$V_{IN} = 2.3 \text{ V}$ , $I_{OUT} = 150 \text{ mA}$	—	—	0.4	V
Control terminal threshold high voltage	$V_{CONTH}$	$V_{IN} = 3.0 \text{ V}$ , $I_{OUT} = 50 \text{ mA}$	—	—	1.50	V
Control terminal threshold low voltage	$V_{CONTL}$	$V_{IN} = 3.0 \text{ V}$ , $I_{OUT} = 50 \text{ mA}$	0.30	—	—	V
Control terminal current	$I_{CONT}$	$V_{IN} = 3.0 \text{ V}$ , $I_{OUT} = 50 \text{ mA}$ $V_{CONT} = 1.8 \text{ V}$	—	—	30	$\mu\text{A}$

Note) \*1:  $1.0 \Omega$

\*2: Peak output current: The output current when the output voltage has been decreased by 5% from the value at the time when the output current is 50 mA due to the overcurrent protection.

#### • Design reference data

Note) The following values are typical and not guaranteed values.

Parameter	Symbol	Conditions	Min	Typ	Max	Unit
Output noise voltage	$V_{NO}$	$10 \text{ Hz} \leq f \leq 100 \text{ kHz}$ , $I_{OUT} = 10 \text{ mA}$	—	42	—	$\mu\text{V}$
Output voltage temperature coefficient	$\frac{1}{V_{OUT}} \cdot \frac{dV_{OUT}}{dT}$	$V_{IN} = 3.0 \text{ V}$ , $I_{OUT} = 0 \text{ mA}$ $-30^\circ\text{C} \leq T_a \leq +85^\circ\text{C}$	—	90	—	ppm/ $^\circ\text{C}$
Output rise time *	$t_{ON}$	$V_{IN} = 3.0 \text{ V}$ , $I_{OUT} = 50 \text{ mA}$ $V_{CONT} = 0 \text{ V} \rightarrow 1.8 \text{ V}$ , $C_{IN} = 0.1 \mu\text{F}$ $C_{OUT} = 10 \mu\text{F}$ , $V_{OUT} = 90\%$	—	0.10	—	ms

Note) \*: Refer to "■ Application Notes 3. Output rise-time characteristics".

## ■ Electrical Characteristics at $T_a = 25^\circ\text{C}$ (continued)

### • AN80L21RMS (2.1 V type)

Unless otherwise specially provided, shorten each test time (within 10 ms) so that the test is conducted under the condition that the drift due to the temperature increase in the chip junction part can be neglected.  $C_{IN} = 0.1 \mu\text{F}$ ,  $C_{OUT} = 10 \mu\text{F}$

Parameter	Symbol	Conditions	Min	Typ	Max	Unit
Output voltage	$V_{OUT}$	$V_{IN} = 3.1 \text{ V}$ , $I_{OUT} = 50 \text{ mA}$	2.037	2.1	2.163	V
Line regulation 1	$REG_{IN1}$	$V_{IN} = 3.1 \text{ V} \rightarrow 14.5 \text{ V}$ , $I_{OUT} = 50 \text{ mA}$	—	10	50	mV
Line regulation 2	$REG_{IN2}$	$V_{IN} = 3.1 \text{ V} \rightarrow 9 \text{ V}$ , $I_{OUT} = 50 \text{ mA}$	—	5	20	mV
Load regulation *1	$REG_{LOA}$	$V_{IN} = 3.1 \text{ V}$ , $I_{OUT} = 0 \text{ mA} \rightarrow 150 \text{ mA}$	—	50	150	mV
Peak output current *2	$I_{PEAK}$	$V_{IN} = 3.1 \text{ V}$ , The output current value when $V_{OUT}$ decreases by 5% from its value at $I_{OUT} = 50 \text{ mA}$ .	180	240	—	mA
Bias current under no load	$I_{BIAS}$	$V_{IN} = 3.1 \text{ V}$ , $I_{OUT} = 0 \text{ mA}$	—	—	350	$\mu\text{A}$
Bias current fluctuation to load	$\Delta I_{BIAS}$	$V_{IN} = 3.1 \text{ V}$ , $I_{OUT} = 0 \text{ mA} \rightarrow 150 \text{ mA}$	—	—	5	mA
Standby consumption current	$I_{STB}$	$V_{IN} = 10 \text{ V}$ , $V_{CONT} = 0 \text{ V}$	—	—	0.1	$\mu\text{A}$
Bias current before starting regulation	$I_{RUSH}$	$V_{IN} = 1.8 \text{ V}$ , $I_{OUT} = 0 \text{ mA}$	—	1.5	5	mA
Ripple rejection ratio	RR	1 V[rms], $f = 120 \text{ Hz}$ , $I_{OUT} = 10 \text{ mA}$	61	69	—	dB
Minimum input/output voltage difference 1	$V_{DIF(min)1}$	$V_{IN} = 1.8 \text{ V}$ , $I_{OUT} = 0 \text{ mA}$	—	0.1	0.2	V
Minimum input/output voltage difference 2	$V_{DIF(min)2}$	$V_{IN} = 2.4 \text{ V}$ , $I_{OUT} = 150 \text{ mA}$	—	—	0.4	V
Control terminal threshold high voltage	$V_{CONTH}$	$V_{IN} = 3.1 \text{ V}$ , $I_{OUT} = 50 \text{ mA}$	—	—	1.50	V
Control terminal threshold low voltage	$V_{CONTL}$	$V_{IN} = 3.1 \text{ V}$ , $I_{OUT} = 50 \text{ mA}$	0.30	—	—	V
Control terminal current	$I_{CONT}$	$V_{IN} = 3.1 \text{ V}$ , $I_{OUT} = 50 \text{ mA}$ $V_{CONT} = 1.8 \text{ V}$	—	—	30	$\mu\text{A}$

Note) \*1:  $1.0 \Omega$

\*2: Peak output current: The output current when the output voltage has been decreased by 5% from the value at the time when the output current is 50 mA due to the overcurrent protection.

### • Design reference data

Note) The following values are typical and not guaranteed values.

Parameter	Symbol	Conditions	Min	Typ	Max	Unit
Output noise voltage	$V_{NO}$	$10 \text{ Hz} \leq f \leq 100 \text{ kHz}$ , $I_{OUT} = 10 \text{ mA}$	—	44	—	$\mu\text{V}$
Output voltage temperature coefficient	$\frac{1}{V_{OUT}} \cdot \frac{dV_{OUT}}{dT}$	$V_{IN} = 3.1 \text{ V}$ , $I_{OUT} = 0 \text{ mA}$ $-30^\circ\text{C} \leq T_a \leq +85^\circ\text{C}$	—	90	—	ppm/ $^\circ\text{C}$
Output rise time *	$t_{ON}$	$V_{IN} = 3.1 \text{ V}$ , $I_{OUT} = 50 \text{ mA}$ $V_{CONT} = 0 \text{ V} \rightarrow 1.8 \text{ V}$ , $C_{IN} = 0.1 \mu\text{F}$ $C_{OUT} = 10 \mu\text{F}$ , $V_{OUT} = 90\%$	—	0.10	—	ms

Note) \*: Refer to "■ Application Notes 3. Output rise-time characteristics".

### ■ Electrical Characteristics at $T_a = 25^\circ\text{C}$ (continued)

#### • AN80L22RMS (2.2 V type)

Unless otherwise specially provided, shorten each test time (within 10 ms) so that the test is conducted under the condition that the drift due to the temperature increase in the chip junction part can be neglected.  $C_{IN} = 0.1 \mu\text{F}$ ,  $C_{OUT} = 10 \mu\text{F}$

Parameter	Symbol	Conditions	Min	Typ	Max	Unit
Output voltage	$V_{OUT}$	$V_{IN} = 3.2 \text{ V}$ , $I_{OUT} = 50 \text{ mA}$	2.134	2.2	2.266	V
Line regulation 1	$REG_{IN1}$	$V_{IN} = 3.2 \text{ V} \rightarrow 14.5 \text{ V}$ , $I_{OUT} = 50 \text{ mA}$	—	10	50	mV
Line regulation 2	$REG_{IN2}$	$V_{IN} = 3.2 \text{ V} \rightarrow 9 \text{ V}$ , $I_{OUT} = 50 \text{ mA}$	—	5	20	mV
Load regulation *1	$REG_{LOA}$	$V_{IN} = 3.2 \text{ V}$ , $I_{OUT} = 0 \text{ mA} \rightarrow 150 \text{ mA}$	—	50	150	mV
Peak output current *2	$I_{PEAK}$	$V_{IN} = 3.2 \text{ V}$ , The output current value when $V_{OUT}$ decreases by 5% from its value at $I_{OUT} = 50 \text{ mA}$ .	180	240	—	mA
Bias current under no load	$I_{BIAS}$	$V_{IN} = 3.2 \text{ V}$ , $I_{OUT} = 0 \text{ mA}$	—	—	350	$\mu\text{A}$
Bias current fluctuation to load	$\Delta I_{BIAS}$	$V_{IN} = 3.2 \text{ V}$ , $I_{OUT} = 0 \text{ mA} \rightarrow 150 \text{ mA}$	—	—	5	mA
Standby consumption current	$I_{STB}$	$V_{IN} = 10 \text{ V}$ , $V_{CONT} = 0 \text{ V}$	—	—	0.1	$\mu\text{A}$
Bias current before starting regulation	$I_{RUSH}$	$V_{IN} = 1.9 \text{ V}$ , $I_{OUT} = 0 \text{ mA}$	—	1.5	5	mA
Ripple rejection ratio	RR	1 V[rms], $f = 120 \text{ Hz}$ , $I_{OUT} = 10 \text{ mA}$	61	69	—	dB
Minimum input/output voltage difference 1	$V_{DIF(min)1}$	$V_{IN} = 1.9 \text{ V}$ , $I_{OUT} = 0 \text{ mA}$	—	0.1	0.2	V
Minimum input/output voltage difference 2	$V_{DIF(min)2}$	$V_{IN} = 2.4 \text{ V}$ , $I_{OUT} = 150 \text{ mA}$	—	—	0.4	V
Control terminal threshold high voltage	$V_{CONTH}$	$V_{IN} = 3.2 \text{ V}$ , $I_{OUT} = 50 \text{ mA}$	—	—	1.50	V
Control terminal threshold low voltage	$V_{CONTL}$	$V_{IN} = 3.2 \text{ V}$ , $I_{OUT} = 50 \text{ mA}$	0.30	—	—	V
Control terminal current	$I_{CONT}$	$V_{IN} = 3.2 \text{ V}$ , $I_{OUT} = 50 \text{ mA}$ $V_{CONT} = 1.8 \text{ V}$	—	—	30	$\mu\text{A}$

Note) \*1:  $1.0 \Omega$

\*2: Peak output current: The output current when the output voltage has been decreased by 5% from the value at the time when the output current is 50 mA due to the overcurrent protection.

#### • Design reference data

Note) The following values are typical and not guaranteed values.

Parameter	Symbol	Conditions	Min	Typ	Max	Unit
Output noise voltage	$V_{NO}$	$10 \text{ Hz} \leq f \leq 100 \text{ kHz}$ , $I_{OUT} = 10 \text{ mA}$	—	46	—	$\mu\text{V}$
Output voltage temperature coefficient	$\frac{1}{V_{OUT}} \cdot \frac{dV_{OUT}}{dT}$	$V_{IN} = 3.2 \text{ V}$ , $I_{OUT} = 0 \text{ mA}$ $-30^\circ\text{C} \leq T_a \leq +85^\circ\text{C}$	—	90	—	ppm/ $^\circ\text{C}$
Output rise time *	$t_{ON}$	$V_{IN} = 3.2 \text{ V}$ , $I_{OUT} = 50 \text{ mA}$ $V_{CONT} = 0 \text{ V} \rightarrow 1.8 \text{ V}$ , $C_{IN} = 0.1 \mu\text{F}$ $C_{OUT} = 10 \mu\text{F}$ , $V_{OUT} = 90\%$	—	0.10	—	ms

Note) \*: Refer to "■ Application Notes 3. Output rise-time characteristics".

### ■ Electrical Characteristics at $T_a = 25^\circ\text{C}$ (continued)

#### • AN80L25RMS (2.5 V type)

Unless otherwise specially provided, shorten each test time (within 10 ms) so that the test is conducted under the condition that the drift due to the temperature increase in the chip junction part can be neglected.  $C_{IN} = 0.1 \mu\text{F}$ ,  $C_{OUT} = 10 \mu\text{F}$

Parameter	Symbol	Conditions	Min	Typ	Max	Unit
Output voltage	$V_{OUT}$	$V_{IN} = 3.5 \text{ V}$ , $I_{OUT} = 50 \text{ mA}$	2.425	2.5	2.575	V
Line regulation 1	$REG_{IN1}$	$V_{IN} = 3.5 \text{ V} \rightarrow 14.5 \text{ V}$ , $I_{OUT} = 50 \text{ mA}$	—	10	50	mV
Line regulation 2	$REG_{IN2}$	$V_{IN} = 3.5 \text{ V} \rightarrow 9 \text{ V}$ , $I_{OUT} = 50 \text{ mA}$	—	5	20	mV
Load regulation *1	$REG_{LOA}$	$V_{IN} = 3.5 \text{ V}$ , $I_{OUT} = 0 \text{ mA} \rightarrow 150 \text{ mA}$	—	50	150	mV
Peak output current *2	$I_{PEAK}$	$V_{IN} = 3.5 \text{ V}$ , The output current value when $V_{OUT}$ decreases by 5% from its value at $I_{OUT} = 50 \text{ mA}$ .	180	240	—	mA
Bias current under no load	$I_{BIAS}$	$V_{IN} = 3.5 \text{ V}$ , $I_{OUT} = 0 \text{ mA}$	—	—	350	$\mu\text{A}$
Bias current fluctuation to load	$\Delta I_{BIAS}$	$V_{IN} = 3.5 \text{ V}$ , $I_{OUT} = 0 \text{ mA} \rightarrow 150 \text{ mA}$	—	—	5	mA
Standby consumption current	$I_{STB}$	$V_{IN} = 10 \text{ V}$ , $V_{CONT} = 0 \text{ V}$	—	—	0.1	$\mu\text{A}$
Bias current before starting regulation	$I_{RUSH}$	$V_{IN} = 2.2 \text{ V}$ , $I_{OUT} = 0 \text{ mA}$	—	1.5	5	mA
Ripple rejection ratio	RR	1 V[rms], $f = 120 \text{ Hz}$ , $I_{OUT} = 10 \text{ mA}$	60	68	—	dB
Minimum input/output voltage difference 1	$V_{DIF(min)1}$	$V_{IN} = 2.2 \text{ V}$ , $I_{OUT} = 0 \text{ mA}$	—	0.1	0.2	V
Minimum input/output voltage difference 2	$V_{DIF(min)2}$	$V_{IN} = 2.6 \text{ V}$ , $I_{OUT} = 150 \text{ mA}$	—	—	0.4	V
Control terminal threshold high voltage	$V_{CONTH}$	$V_{IN} = 3.5 \text{ V}$ , $I_{OUT} = 50 \text{ mA}$	—	—	1.50	V
Control terminal threshold low voltage	$V_{CONTL}$	$V_{IN} = 3.5 \text{ V}$ , $I_{OUT} = 50 \text{ mA}$	0.30	—	—	V
Control terminal current	$I_{CONT}$	$V_{IN} = 3.5 \text{ V}$ , $I_{OUT} = 50 \text{ mA}$ $V_{CONT} = 1.8 \text{ V}$	—	—	30	$\mu\text{A}$

Note) \*1:  $1.0 \Omega$

\*2: Peak output current: The output current when the output voltage has been decreased by 5% from the value at the time when the output current is 50 mA due to the overcurrent protection.

#### • Design reference data

Note) The following values are typical and not guaranteed values.

Parameter	Symbol	Conditions	Min	Typ	Max	Unit
Output noise voltage	$V_{NO}$	$10 \text{ Hz} \leq f \leq 100 \text{ kHz}$ , $I_{OUT} = 10 \text{ mA}$	—	58	—	$\mu\text{V}$
Output voltage temperature coefficient	$\frac{1}{V_{OUT}} \cdot \frac{dV_{OUT}}{dT}$	$V_{IN} = 3.5 \text{ V}$ , $I_{OUT} = 0 \text{ mA}$ $-30^\circ\text{C} \leq T_a \leq +85^\circ\text{C}$	—	90	—	ppm/ $^\circ\text{C}$
Output rise time *	$t_{ON}$	$V_{IN} = 3.15 \text{ V}$ , $I_{OUT} = 50 \text{ mA}$ $V_{CONT} = 0 \text{ V} \rightarrow 1.8 \text{ V}$ , $C_{IN} = 0.1 \mu\text{F}$ $C_{OUT} = 10 \mu\text{F}$ , $V_{OUT} = 90\%$	—	0.10	—	ms

Note) \*: Refer to "■ Application Notes 3. Output rise-time characteristics".

### ■ Electrical Characteristics at $T_a = 25^\circ\text{C}$ (continued)

#### • AN80L28RMS (2.8 V type)

Unless otherwise specially provided, shorten each test time (within 10 ms) so that the test is conducted under the condition that the drift due to the temperature increase in the chip junction part can be neglected.  $C_{IN} = 0.1 \mu\text{F}$ ,  $C_{OUT} = 10 \mu\text{F}$

Parameter	Symbol	Conditions	Min	Typ	Max	Unit
Output voltage	$V_{OUT}$	$V_{IN} = 3.8 \text{ V}$ , $I_{OUT} = 50 \text{ mA}$	2.716	2.8	2.884	V
Line regulation 1	$REG_{IN1}$	$V_{IN} = 3.8 \text{ V} \rightarrow 14.5 \text{ V}$ , $I_{OUT} = 50 \text{ mA}$	—	10	50	mV
Line regulation 2	$REG_{IN2}$	$V_{IN} = 3.8 \text{ V} \rightarrow 9 \text{ V}$ , $I_{OUT} = 50 \text{ mA}$	—	5	20	mV
Load regulation *1	$REG_{LOA}$	$V_{IN} = 3.8 \text{ V}$ , $I_{OUT} = 0 \text{ mA} \rightarrow 150 \text{ mA}$	—	50	150	mV
Peak output current *2	$I_{PEAK}$	$V_{IN} = 3.8 \text{ V}$ , The output current value when $V_{OUT}$ decreases by 5% from its value at $I_{OUT} = 50 \text{ mA}$ .	180	240	—	mA
Bias current under no load	$I_{BIAS}$	$V_{IN} = 3.8 \text{ V}$ , $I_{OUT} = 0 \text{ mA}$	—	—	350	$\mu\text{A}$
Bias current fluctuation to load	$\Delta I_{BIAS}$	$V_{IN} = 3.8 \text{ V}$ , $I_{OUT} = 0 \text{ mA} \rightarrow 150 \text{ mA}$	—	—	5	mA
Standby consumption current	$I_{STB}$	$V_{IN} = 10 \text{ V}$ , $V_{CONT} = 0 \text{ V}$	—	—	0.1	$\mu\text{A}$
Bias current before starting regulation	$I_{RUSH}$	$V_{IN} = 2.5 \text{ V}$ , $I_{OUT} = 0 \text{ mA}$	—	1.5	5	mA
Ripple rejection ratio	RR	1 V[rms], $f = 120 \text{ Hz}$ , $I_{OUT} = 10 \text{ mA}$	60	68	—	dB
Minimum input/output voltage difference 1	$V_{DIF(min)1}$	$V_{IN} = 2.5 \text{ V}$ , $I_{OUT} = 0 \text{ mA}$	—	0.1	0.2	V
Minimum input/output voltage difference 2	$V_{DIF(min)2}$	$V_{IN} = 2.9 \text{ V}$ , $I_{OUT} = 150 \text{ mA}$	—	—	0.4	V
Control terminal threshold high voltage	$V_{CONTH}$	$V_{IN} = 3.8 \text{ V}$ , $I_{OUT} = 50 \text{ mA}$	—	—	1.50	V
Control terminal threshold low voltage	$V_{CONTL}$	$V_{IN} = 3.8 \text{ V}$ , $I_{OUT} = 50 \text{ mA}$	0.30	—	—	V
Control terminal current	$I_{CONT}$	$V_{IN} = 3.8 \text{ V}$ , $I_{OUT} = 50 \text{ mA}$ $V_{CONT} = 1.8 \text{ V}$	—	—	30	$\mu\text{A}$

Note) \*1:  $1.0 \Omega$

\*2: Peak output current: The output current when the output voltage has been decreased by 5% from the value at the time when the output current is 50 mA due to the overcurrent protection.

#### • Design reference data

Note) The following values are typical and not guaranteed values.

Parameter	Symbol	Conditions	Min	Typ	Max	Unit
Output noise voltage	$V_{NO}$	$10 \text{ Hz} \leq f \leq 100 \text{ kHz}$ , $I_{OUT} = 10 \text{ mA}$	—	58	—	$\mu\text{V}$
Output voltage temperature coefficient	$\frac{1}{V_{OUT}} \cdot \frac{dV_{OUT}}{dT}$	$V_{IN} = 3.8 \text{ V}$ , $I_{OUT} = 0 \text{ mA}$ $-30^\circ\text{C} \leq T_a \leq +85^\circ\text{C}$	—	90	—	ppm/ $^\circ\text{C}$
Output rise time *	$t_{ON}$	$V_{IN} = 3.8 \text{ V}$ , $I_{OUT} = 50 \text{ mA}$ $V_{CONT} = 0 \text{ V} \rightarrow 1.8 \text{ V}$ , $C_{IN} = 0.1 \mu\text{F}$ $C_{OUT} = 10 \mu\text{F}$ , $V_{OUT} = 90\%$	—	0.10	—	ms

Note) \*: Refer to "■ Application Notes 3. Output rise-time characteristics".

### ■ Electrical Characteristics at $T_a = 25^\circ\text{C}$ (continued)

#### • AN80L29RMS (2.9 V type)

Unless otherwise specially provided, shorten each test time (within 10 ms) so that the test is conducted under the condition that the drift due to the temperature increase in the chip junction part can be neglected.  $C_{IN} = 0.1 \mu\text{F}$ ,  $C_{OUT} = 10 \mu\text{F}$

Parameter	Symbol	Conditions	Min	Typ	Max	Unit
Output voltage	$V_{OUT}$	$V_{IN} = 3.9 \text{ V}$ , $I_{OUT} = 50 \text{ mA}$	2.813	2.9	2.987	V
Line regulation 1	$REG_{IN1}$	$V_{IN} = 3.9 \text{ V} \rightarrow 14.5 \text{ V}$ , $I_{OUT} = 50 \text{ mA}$	—	10	50	mV
Line regulation 2	$REG_{IN2}$	$V_{IN} = 3.9 \text{ V} \rightarrow 9 \text{ V}$ , $I_{OUT} = 50 \text{ mA}$	—	5	20	mV
Load regulation *1	$REG_{LOA}$	$V_{IN} = 3.9 \text{ V}$ , $I_{OUT} = 0 \text{ mA} \rightarrow 150 \text{ mA}$	—	50	150	mV
Peak output current *2	$I_{PEAK}$	$V_{IN} = 3.9 \text{ V}$ , The output current value when $V_{OUT}$ decreases by 5% from its value at $I_{OUT} = 50 \text{ mA}$ .	180	240	—	mA
Bias current under no load	$I_{BIAS}$	$V_{IN} = 3.9 \text{ V}$ , $I_{OUT} = 0 \text{ mA}$	—	—	350	$\mu\text{A}$
Bias current fluctuation to load	$\Delta I_{BIAS}$	$V_{IN} = 3.9 \text{ V}$ , $I_{OUT} = 0 \text{ mA} \rightarrow 150 \text{ mA}$	—	—	5	mA
Standby consumption current	$I_{STB}$	$V_{IN} = 10 \text{ V}$ , $V_{CONT} = 0 \text{ V}$	—	—	0.1	$\mu\text{A}$
Bias current before starting regulation	$I_{RUSH}$	$V_{IN} = 2.6 \text{ V}$ , $I_{OUT} = 0 \text{ mA}$	—	1.5	5	mA
Ripple rejection ratio	RR	1 V[rms], $f = 120 \text{ Hz}$ , $I_{OUT} = 10 \text{ mA}$	60	68	—	dB
Minimum input/output voltage difference 1	$V_{DIF(min)1}$	$V_{IN} = 2.6 \text{ V}$ , $I_{OUT} = 0 \text{ mA}$	—	0.1	0.2	V
Minimum input/output voltage difference 2	$V_{DIF(min)2}$	$V_{IN} = 3.0 \text{ V}$ , $I_{OUT} = 150 \text{ mA}$	—	—	0.4	V
Control terminal threshold high voltage	$V_{CONTH}$	$V_{IN} = 3.9 \text{ V}$ , $I_{OUT} = 50 \text{ mA}$	—	—	1.50	V
Control terminal threshold low voltage	$V_{CONTL}$	$V_{IN} = 3.9 \text{ V}$ , $I_{OUT} = 50 \text{ mA}$	0.30	—	—	V
Control terminal current	$I_{CONT}$	$V_{IN} = 3.9 \text{ V}$ , $I_{OUT} = 50 \text{ mA}$ $V_{CONT} = 1.8 \text{ V}$	—	—	30	$\mu\text{A}$

Note) \*1:  $1.0 \Omega$

\*2: Peak output current: The output current when the output voltage has been decreased by 5% from the value at the time when the output current is 50 mA due to the overcurrent protection.

#### • Design reference data

Note) The following values are typical and not guaranteed values.

Parameter	Symbol	Conditions	Min	Typ	Max	Unit
Output noise voltage	$V_{NO}$	$10 \text{ Hz} \leq f \leq 100 \text{ kHz}$ , $I_{OUT} = 10 \text{ mA}$	—	60	—	$\mu\text{V}$
Output voltage temperature coefficient	$\frac{1}{V_{OUT}} \cdot \frac{dV_{OUT}}{dT}$	$V_{IN} = 3.9 \text{ V}$ , $I_{OUT} = 0 \text{ mA}$ $-30^\circ\text{C} \leq T_a \leq +85^\circ\text{C}$	—	90	—	ppm/ $^\circ\text{C}$
Output rise time *	$t_{ON}$	$V_{IN} = 3.9 \text{ V}$ , $I_{OUT} = 50 \text{ mA}$ $V_{CONT} = 0 \text{ V} \rightarrow 1.8 \text{ V}$ , $C_{IN} = 0.1 \mu\text{F}$ $C_{OUT} = 10 \mu\text{F}$ , $V_{OUT} = 90\%$	—	0.12	—	ms

Note) \*: Refer to "■ Application Notes 3. Output rise-time characteristics".

### ■ Electrical Characteristics at $T_a = 25^\circ\text{C}$ (continued)

#### • AN80L30RMS (3.0 V type)

Unless otherwise specially provided, shorten each test time (within 10 ms) so that the test is conducted under the condition that the drift due to the temperature increase in the chip junction part can be neglected.  $C_{IN} = 0.1 \mu\text{F}$ ,  $C_{OUT} = 10 \mu\text{F}$

Parameter	Symbol	Conditions	Min	Typ	Max	Unit
Output voltage	$V_{OUT}$	$V_{IN} = 4.0 \text{ V}$ , $I_{OUT} = 50 \text{ mA}$	2.910	3.0	3.090	V
Line regulation 1	$REG_{IN1}$	$V_{IN} = 4.0 \text{ V} \rightarrow 14.5 \text{ V}$ , $I_{OUT} = 50 \text{ mA}$	—	10	50	mV
Line regulation 2	$REG_{IN2}$	$V_{IN} = 4.0 \text{ V} \rightarrow 9 \text{ V}$ , $I_{OUT} = 50 \text{ mA}$	—	5	20	mV
Load regulation *1	$REG_{LOA}$	$V_{IN} = 4.0 \text{ V}$ , $I_{OUT} = 0 \text{ mA} \rightarrow 150 \text{ mA}$	—	50	150	mV
Peak output current *2	$I_{PEAK}$	$V_{IN} = 4.0 \text{ V}$ , The output current value when $V_{OUT}$ decreases by 5% from its value at $I_{OUT} = 50 \text{ mA}$ .	180	240	—	mA
Bias current under no load	$I_{BIAS}$	$V_{IN} = 4.0 \text{ V}$ , $I_{OUT} = 0 \text{ mA}$	—	—	350	$\mu\text{A}$
Bias current fluctuation to load	$\Delta I_{BIAS}$	$V_{IN} = 4.0 \text{ V}$ , $I_{OUT} = 0 \text{ mA} \rightarrow 150 \text{ mA}$	—	—	5	mA
Standby consumption current	$I_{STB}$	$V_{IN} = 10 \text{ V}$ , $V_{CONT} = 0 \text{ V}$	—	—	0.1	$\mu\text{A}$
Bias current before starting regulation	$I_{RUSH}$	$V_{IN} = 2.7 \text{ V}$ , $I_{OUT} = 0 \text{ mA}$	—	1.5	5	mA
Ripple rejection ratio	RR	1 V[rms], $f = 120 \text{ Hz}$ , $I_{OUT} = 10 \text{ mA}$	60	68	—	dB
Minimum input/output voltage difference 1	$V_{DIF(min)1}$	$V_{IN} = 2.7 \text{ V}$ , $I_{OUT} = 0 \text{ mA}$	—	0.1	0.2	V
Minimum input/output voltage difference 2	$V_{DIF(min)2}$	$V_{IN} = 3.1 \text{ V}$ , $I_{OUT} = 150 \text{ mA}$	—	—	0.4	V
Control terminal threshold high voltage	$V_{CONTH}$	$V_{IN} = 4.0 \text{ V}$ , $I_{OUT} = 50 \text{ mA}$	—	—	1.50	V
Control terminal threshold low voltage	$V_{CONTL}$	$V_{IN} = 4.0 \text{ V}$ , $I_{OUT} = 50 \text{ mA}$	0.30	—	—	V
Control terminal current	$I_{CONT}$	$V_{IN} = 4.0 \text{ V}$ , $I_{OUT} = 50 \text{ mA}$ $V_{CONT} = 1.8 \text{ V}$	—	—	30	$\mu\text{A}$

Note) \*1:  $1.0 \Omega$

\*2: Peak output current: The output current when the output voltage has been decreased by 5% from the value at the time when the output current is 50 mA due to the overcurrent protection.

#### • Design reference data

Note) The following values are typical and not guaranteed values.

Parameter	Symbol	Conditions	Min	Typ	Max	Unit
Output noise voltage	$V_{NO}$	$10 \text{ Hz} \leq f \leq 100 \text{ kHz}$ , $I_{OUT} = 10 \text{ mA}$	—	62	—	$\mu\text{V}$
Output voltage temperature coefficient	$\frac{1}{V_{OUT}} \cdot \frac{dV_{OUT}}{dT}$	$V_{IN} = 4.0 \text{ V}$ , $I_{OUT} = 0 \text{ mA}$ $-30^\circ\text{C} \leq T_a \leq +85^\circ\text{C}$	—	90	—	ppm/ $^\circ\text{C}$
Output rise time *	$t_{ON}$	$V_{IN} = 4.0 \text{ V}$ , $I_{OUT} = 50 \text{ mA}$ $V_{CONT} = 0 \text{ V} \rightarrow 1.8 \text{ V}$ , $C_{IN} = 0.1 \mu\text{F}$ $C_{OUT} = 10 \mu\text{F}$ , $V_{OUT} = 90\%$	—	0.12	—	ms

Note) \*: Refer to "■ Application Notes 3. Output rise-time characteristics".

### ■ Electrical Characteristics at $T_a = 25^\circ\text{C}$ (continued)

#### • AN80L31RMS (3.1 V type)

Unless otherwise specially provided, shorten each test time (within 10 ms) so that the test is conducted under the condition that the drift due to the temperature increase in the chip junction part can be neglected.  $C_{IN} = 0.1 \mu\text{F}$ ,  $C_{OUT} = 10 \mu\text{F}$

Parameter	Symbol	Conditions	Min	Typ	Max	Unit
Output voltage	$V_{OUT}$	$V_{IN} = 4.1 \text{ V}$ , $I_{OUT} = 50 \text{ mA}$	3.007	3.1	3.193	V
Line regulation 1	$REG_{IN1}$	$V_{IN} = 4.1 \text{ V} \rightarrow 14.5 \text{ V}$ , $I_{OUT} = 50 \text{ mA}$	—	10	50	mV
Line regulation 2	$REG_{IN2}$	$V_{IN} = 4.1 \text{ V} \rightarrow 9 \text{ V}$ , $I_{OUT} = 50 \text{ mA}$	—	5	20	mV
Load regulation *1	$REG_{LOA}$	$V_{IN} = 4.1 \text{ V}$ , $I_{OUT} = 0 \text{ mA} \rightarrow 150 \text{ mA}$	—	50	150	mV
Peak output current *2	$I_{PEAK}$	$V_{IN} = 4.1 \text{ V}$ , The output current value when $V_{OUT}$ decreases by 5% from its value at $I_{OUT} = 50 \text{ mA}$ .	180	240	—	mA
Bias current under no load	$I_{BIAS}$	$V_{IN} = 4.1 \text{ V}$ , $I_{OUT} = 0 \text{ mA}$	—	—	350	$\mu\text{A}$
Bias current fluctuation to load	$\Delta I_{BIAS}$	$V_{IN} = 4.1 \text{ V}$ , $I_{OUT} = 0 \text{ mA} \rightarrow 150 \text{ mA}$	—	—	5	mA
Standby consumption current	$I_{STB}$	$V_{IN} = 10 \text{ V}$ , $V_{CONT} = 0 \text{ V}$	—	—	0.1	$\mu\text{A}$
Bias current before starting regulation	$I_{RUSH}$	$V_{IN} = 2.8 \text{ V}$ , $I_{OUT} = 0 \text{ mA}$	—	1.5	5	mA
Ripple rejection ratio	RR	1 V[rms], $f = 120 \text{ Hz}$ , $I_{OUT} = 10 \text{ mA}$	59	67	—	dB
Minimum input/output voltage difference 1	$V_{DIF(min)1}$	$V_{IN} = 2.8 \text{ V}$ , $I_{OUT} = 0 \text{ mA}$	—	0.1	0.2	V
Minimum input/output voltage difference 2	$V_{DIF(min)2}$	$V_{IN} = 3.2 \text{ V}$ , $I_{OUT} = 150 \text{ mA}$	—	—	0.4	V
Control terminal threshold high voltage	$V_{CONTH}$	$V_{IN} = 4.1 \text{ V}$ , $I_{OUT} = 50 \text{ mA}$	—	—	1.50	V
Control terminal threshold low voltage	$V_{CONTL}$	$V_{IN} = 4.1 \text{ V}$ , $I_{OUT} = 50 \text{ mA}$	0.30	—	—	V
Control terminal current	$I_{CONT}$	$V_{IN} = 4.1 \text{ V}$ , $I_{OUT} = 50 \text{ mA}$ $V_{CONT} = 1.8 \text{ V}$	—	—	30	$\mu\text{A}$

Note) \*1:  $1.0 \Omega$

\*2: Peak output current: The output current when the output voltage has been decreased by 5% from the value at the time when the output current is 50 mA due to the overcurrent protection.

#### • Design reference data

Note) The following values are typical and not guaranteed values.

Parameter	Symbol	Conditions	Min	Typ	Max	Unit
Output noise voltage	$V_{NO}$	$10 \text{ Hz} \leq f \leq 100 \text{ kHz}$ , $I_{OUT} = 10 \text{ mA}$	—	64	—	$\mu\text{V}$
Output voltage temperature coefficient	$\frac{1}{V_{OUT}} \cdot \frac{dV_{OUT}}{dT}$	$V_{IN} = 4.1 \text{ V}$ , $I_{OUT} = 0 \text{ mA}$ $-30^\circ\text{C} \leq T_a \leq +85^\circ\text{C}$	—	90	—	ppm/ $^\circ\text{C}$
Output rise time *	$t_{ON}$	$V_{IN} = 4.1 \text{ V}$ , $I_{OUT} = 50 \text{ mA}$ $V_{CONT} = 0 \text{ V} \rightarrow 1.8 \text{ V}$ , $C_{IN} = 0.1 \mu\text{F}$ $C_{OUT} = 10 \mu\text{F}$ , $V_{OUT} = 90\%$	—	0.12	—	ms

Note) \*: Refer to "■ Application Notes 3. Output rise-time characteristics".

### ■ Electrical Characteristics at $T_a = 25^\circ\text{C}$ (continued)

#### • AN80L32RMS (3.2 V type)

Unless otherwise specially provided, shorten each test time (within 10 ms) so that the test is conducted under the condition that the drift due to the temperature increase in the chip junction part can be neglected.  $C_{IN} = 0.1 \mu\text{F}$ ,  $C_{OUT} = 10 \mu\text{F}$

Parameter	Symbol	Conditions	Min	Typ	Max	Unit
Output voltage	$V_{OUT}$	$V_{IN} = 4.2 \text{ V}$ , $I_{OUT} = 50 \text{ mA}$	3.104	3.2	3.296	V
Line regulation 1	$REG_{IN1}$	$V_{IN} = 4.2 \text{ V} \rightarrow 14.5 \text{ V}$ , $I_{OUT} = 50 \text{ mA}$	—	10	50	mV
Line regulation 2	$REG_{IN2}$	$V_{IN} = 4.2 \text{ V} \rightarrow 9 \text{ V}$ , $I_{OUT} = 50 \text{ mA}$	—	5	20	mV
Load regulation *1	$REG_{LOA}$	$V_{IN} = 4.2 \text{ V}$ , $I_{OUT} = 0 \text{ mA} \rightarrow 150 \text{ mA}$	—	50	150	mV
Peak output current *2	$I_{PEAK}$	$V_{IN} = 4.2 \text{ V}$ , The output current value when $V_{OUT}$ decreases by 5% from its value at $I_{OUT} = 50 \text{ mA}$ .	180	240	—	mA
Bias current under no load	$I_{BIAS}$	$V_{IN} = 4.2 \text{ V}$ , $I_{OUT} = 0 \text{ mA}$	—	—	350	$\mu\text{A}$
Bias current fluctuation to load	$\Delta I_{BIAS}$	$V_{IN} = 4.2 \text{ V}$ , $I_{OUT} = 0 \text{ mA} \rightarrow 150 \text{ mA}$	—	—	5	mA
Standby consumption current	$I_{STB}$	$V_{IN} = 10 \text{ V}$ , $V_{CONT} = 0 \text{ V}$	—	—	0.1	$\mu\text{A}$
Bias current before starting regulation	$I_{RUSH}$	$V_{IN} = 2.9 \text{ V}$ , $I_{OUT} = 0 \text{ mA}$	—	1.5	5	mA
Ripple rejection ratio	RR	1 V[rms], $f = 120 \text{ Hz}$ , $I_{OUT} = 10 \text{ mA}$	59	67	—	dB
Minimum input/output voltage difference 1	$V_{DIF(min)1}$	$V_{IN} = 2.9 \text{ V}$ , $I_{OUT} = 0 \text{ mA}$	—	0.1	0.2	V
Minimum input/output voltage difference 2	$V_{DIF(min)2}$	$V_{IN} = 3.3 \text{ V}$ , $I_{OUT} = 150 \text{ mA}$	—	—	0.4	V
Control terminal threshold high voltage	$V_{CONTH}$	$V_{IN} = 4.2 \text{ V}$ , $I_{OUT} = 50 \text{ mA}$	—	—	1.50	V
Control terminal threshold low voltage	$V_{CONTL}$	$V_{IN} = 4.2 \text{ V}$ , $I_{OUT} = 50 \text{ mA}$	0.30	—	—	V
Control terminal current	$I_{CONT}$	$V_{IN} = 4.2 \text{ V}$ , $I_{OUT} = 50 \text{ mA}$ $V_{CONT} = 1.8 \text{ V}$	—	—	30	$\mu\text{A}$

Note) \*1:  $1.0 \Omega$

\*2: Peak output current: The output current when the output voltage has been decreased by 5% from the value at the time when the output current is 50 mA due to the overcurrent protection.

#### • Design reference data

Note) The following values are typical and not guaranteed values.

Parameter	Symbol	Conditions	Min	Typ	Max	Unit
Output noise voltage	$V_{NO}$	$10 \text{ Hz} \leq f \leq 100 \text{ kHz}$ , $I_{OUT} = 10 \text{ mA}$	—	66	—	$\mu\text{V}$
Output voltage temperature coefficient	$\frac{1}{V_{OUT}} \cdot \frac{dV_{OUT}}{dT}$	$V_{IN} = 4.2 \text{ V}$ , $I_{OUT} = 0 \text{ mA}$ $-30^\circ\text{C} \leq T_a \leq +85^\circ\text{C}$	—	90	—	ppm/ $^\circ\text{C}$
Output rise time *	$t_{ON}$	$V_{IN} = 4.2 \text{ V}$ , $I_{OUT} = 50 \text{ mA}$ $V_{CONT} = 0 \text{ V} \rightarrow 1.8 \text{ V}$ , $C_{IN} = 0.1 \mu\text{F}$ $C_{OUT} = 10 \mu\text{F}$ , $V_{OUT} = 90\%$	—	0.12	—	ms

Note) \*: Refer to "■ Application Notes 3. Output rise-time characteristics".

### ■ Electrical Characteristics at $T_a = 25^\circ\text{C}$ (continued)

#### • AN80L33RMS (3.3 V type)

Unless otherwise specially provided, shorten each test time (within 10 ms) so that the test is conducted under the condition that the drift due to the temperature increase in the chip junction part can be neglected.  $C_{IN} = 0.1 \mu\text{F}$ ,  $C_{OUT} = 10 \mu\text{F}$

Parameter	Symbol	Conditions	Min	Typ	Max	Unit
Output voltage	$V_{OUT}$	$V_{IN} = 4.3 \text{ V}$ , $I_{OUT} = 50 \text{ mA}$	3.201	3.3	3.399	V
Line regulation 1	$REG_{IN1}$	$V_{IN} = 4.3 \text{ V} \rightarrow 14.5 \text{ V}$ , $I_{OUT} = 50 \text{ mA}$	—	10	50	mV
Line regulation 2	$REG_{IN2}$	$V_{IN} = 4.3 \text{ V} \rightarrow 9 \text{ V}$ , $I_{OUT} = 50 \text{ mA}$	—	5	20	mV
Load regulation *1	$REG_{LOA}$	$V_{IN} = 4.3 \text{ V}$ , $I_{OUT} = 0 \text{ mA} \rightarrow 150 \text{ mA}$	—	50	150	mV
Peak output current *2	$I_{PEAK}$	$V_{IN} = 4.3 \text{ V}$ , The output current value when $V_{OUT}$ decreases by 5% from its value at $I_{OUT} = 50 \text{ mA}$ .	180	240	—	mA
Bias current under no load	$I_{BIAS}$	$V_{IN} = 4.3 \text{ V}$ , $I_{OUT} = 0 \text{ mA}$	—	—	350	$\mu\text{A}$
Bias current fluctuation to load	$\Delta I_{BIAS}$	$V_{IN} = 4.3 \text{ V}$ , $I_{OUT} = 0 \text{ mA} \rightarrow 150 \text{ mA}$	—	—	5	mA
Standby consumption current	$I_{STB}$	$V_{IN} = 10 \text{ V}$ , $V_{CONT} = 0 \text{ V}$	—	—	0.1	$\mu\text{A}$
Bias current before starting regulation	$I_{RUSH}$	$V_{IN} = 3.0 \text{ V}$ , $I_{OUT} = 0 \text{ mA}$	—	1.5	5	mA
Ripple rejection ratio	RR	1 V[rms], $f = 120 \text{ Hz}$ , $I_{OUT} = 10 \text{ mA}$	59	67	—	dB
Minimum input/output voltage difference 1	$V_{DIF(min)1}$	$V_{IN} = 3.0 \text{ V}$ , $I_{OUT} = 0 \text{ mA}$	—	0.1	0.2	V
Minimum input/output voltage difference 2	$V_{DIF(min)2}$	$V_{IN} = 3.4 \text{ V}$ , $I_{OUT} = 150 \text{ mA}$	—	—	0.4	V
Control terminal threshold high voltage	$V_{CONTH}$	$V_{IN} = 4.3 \text{ V}$ , $I_{OUT} = 50 \text{ mA}$	—	—	1.50	V
Control terminal threshold low voltage	$V_{CONTL}$	$V_{IN} = 4.3 \text{ V}$ , $I_{OUT} = 50 \text{ mA}$	0.30	—	—	V
Control terminal current	$I_{CONT}$	$V_{IN} = 4.3 \text{ V}$ , $I_{OUT} = 50 \text{ mA}$ $V_{CONT} = 1.8 \text{ V}$	—	—	30	$\mu\text{A}$

Note) \*1:  $1.0 \Omega$

\*2: Peak output current: The output current when the output voltage has been decreased by 5% from the value at the time when the output current is 50 mA due to the overcurrent protection.

#### • Design reference data

Note) The following values are typical and not guaranteed values.

Parameter	Symbol	Conditions	Min	Typ	Max	Unit
Output noise voltage	$V_{NO}$	$10 \text{ Hz} \leq f \leq 100 \text{ kHz}$ , $I_{OUT} = 10 \text{ mA}$	—	68	—	$\mu\text{V}$
Output voltage temperature coefficient	$\frac{1}{V_{OUT}} \cdot \frac{dV_{OUT}}{dT}$	$V_{IN} = 4.3 \text{ V}$ , $I_{OUT} = 0 \text{ mA}$ $-30^\circ\text{C} \leq T_a \leq +85^\circ\text{C}$	—	90	—	ppm/ $^\circ\text{C}$
Output rise time *	$t_{ON}$	$V_{IN} = 4.3 \text{ V}$ , $I_{OUT} = 50 \text{ mA}$ $V_{CONT} = 0 \text{ V} \rightarrow 1.8 \text{ V}$ , $C_{IN} = 0.1 \mu\text{F}$ $C_{OUT} = 10 \mu\text{F}$ , $V_{OUT} = 90\%$	—	0.12	—	ms

Note) \*: Refer to "■ Application Notes 3. Output rise-time characteristics".

### ■ Electrical Characteristics at $T_a = 25^\circ\text{C}$ (continued)

#### • AN80L34RMS (3.4 V type)

Unless otherwise specially provided, shorten each test time (within 10 ms) so that the test is conducted under the condition that the drift due to the temperature increase in the chip junction part can be neglected.  $C_{IN} = 0.1 \mu\text{F}$ ,  $C_{OUT} = 10 \mu\text{F}$

Parameter	Symbol	Conditions	Min	Typ	Max	Unit
Output voltage	$V_{OUT}$	$V_{IN} = 4.4 \text{ V}$ , $I_{OUT} = 50 \text{ mA}$	3.298	3.4	3.502	V
Line regulation 1	$REG_{IN1}$	$V_{IN} = 4.4 \text{ V} \rightarrow 14.5 \text{ V}$ , $I_{OUT} = 50 \text{ mA}$	—	10	50	mV
Line regulation 2	$REG_{IN2}$	$V_{IN} = 4.4 \text{ V} \rightarrow 9 \text{ V}$ , $I_{OUT} = 50 \text{ mA}$	—	5	20	mV
Load regulation *1	$REG_{LOA}$	$V_{IN} = 4.4 \text{ V}$ , $I_{OUT} = 0 \text{ mA} \rightarrow 150 \text{ mA}$	—	50	150	mV
Peak output current *2	$I_{PEAK}$	$V_{IN} = 4.4 \text{ V}$ , The output current value when $V_{OUT}$ decreases by 5% from its value at $I_{OUT} = 50 \text{ mA}$ .	180	240	—	mA
Bias current under no load	$I_{BIAS}$	$V_{IN} = 4.4 \text{ V}$ , $I_{OUT} = 0 \text{ mA}$	—	—	350	$\mu\text{A}$
Bias current fluctuation to load	$\Delta I_{BIAS}$	$V_{IN} = 4.4 \text{ V}$ , $I_{OUT} = 0 \text{ mA} \rightarrow 150 \text{ mA}$	—	—	5	mA
Standby consumption current	$I_{STB}$	$V_{IN} = 10 \text{ V}$ , $V_{CONT} = 0 \text{ V}$	—	—	0.1	$\mu\text{A}$
Bias current before starting regulation	$I_{RUSH}$	$V_{IN} = 3.1 \text{ V}$ , $I_{OUT} = 0 \text{ mA}$	—	1.5	5	mA
Ripple rejection ratio	RR	1 V[rms], $f = 120 \text{ Hz}$ , $I_{OUT} = 10 \text{ mA}$	58	66	—	dB
Minimum input/output voltage difference 1	$V_{DIF(min)1}$	$V_{IN} = 3.1 \text{ V}$ , $I_{OUT} = 0 \text{ mA}$	—	0.1	0.2	V
Minimum input/output voltage difference 2	$V_{DIF(min)2}$	$V_{IN} = 3.5 \text{ V}$ , $I_{OUT} = 150 \text{ mA}$	—	—	0.4	V
Control terminal threshold high voltage	$V_{CONTH}$	$V_{IN} = 4.4 \text{ V}$ , $I_{OUT} = 50 \text{ mA}$	—	—	1.50	V
Control terminal threshold low voltage	$V_{CONTL}$	$V_{IN} = 4.4 \text{ V}$ , $I_{OUT} = 50 \text{ mA}$	0.30	—	—	V
Control terminal current	$I_{CONT}$	$V_{IN} = 4.4 \text{ V}$ , $I_{OUT} = 50 \text{ mA}$ $V_{CONT} = 1.8 \text{ V}$	—	—	30	$\mu\text{A}$

Note) \*1:  $1.0 \Omega$

\*2: Peak output current: The output current when the output voltage has been decreased by 5% from the value at the time when the output current is 50 mA due to the overcurrent protection.

#### • Design reference data

Note) The following values are typical and not guaranteed values.

Parameter	Symbol	Conditions	Min	Typ	Max	Unit
Output noise voltage	$V_{NO}$	$10 \text{ Hz} \leq f \leq 100 \text{ kHz}$ , $I_{OUT} = 10 \text{ mA}$	—	70	—	$\mu\text{V}$
Output voltage temperature coefficient	$\frac{1}{V_{OUT}} \cdot \frac{dV_{OUT}}{dT}$	$V_{IN} = 4.4 \text{ V}$ , $I_{OUT} = 0 \text{ mA}$ $-30^\circ\text{C} \leq T_a \leq +85^\circ\text{C}$	—	90	—	ppm/ $^\circ\text{C}$
Output rise time *	$t_{ON}$	$V_{IN} = 4.4 \text{ V}$ , $I_{OUT} = 50 \text{ mA}$ $V_{CONT} = 0 \text{ V} \rightarrow 1.8 \text{ V}$ , $C_{IN} = 0.1 \mu\text{F}$ $C_{OUT} = 10 \mu\text{F}$ , $V_{OUT} = 90\%$	—	0.12	—	ms

Note) \*: Refer to "■ Application Notes 3. Output rise-time characteristics".

### ■ Electrical Characteristics at $T_a = 25^\circ\text{C}$ (continued)

#### • AN80L35RMS (3.5 V type)

Unless otherwise specially provided, shorten each test time (within 10 ms) so that the test is conducted under the condition that the drift due to the temperature increase in the chip junction part can be neglected.  $C_{IN} = 0.1 \mu\text{F}$ ,  $C_{OUT} = 10 \mu\text{F}$

Parameter	Symbol	Conditions	Min	Typ	Max	Unit
Output voltage	$V_{OUT}$	$V_{IN} = 4.5 \text{ V}$ , $I_{OUT} = 50 \text{ mA}$	3.395	3.5	3.605	V
Line regulation 1	$REG_{IN1}$	$V_{IN} = 4.5 \text{ V} \rightarrow 14.5 \text{ V}$ , $I_{OUT} = 50 \text{ mA}$	—	10	50	mV
Line regulation 2	$REG_{IN2}$	$V_{IN} = 4.5 \text{ V} \rightarrow 9 \text{ V}$ , $I_{OUT} = 50 \text{ mA}$	—	5	20	mV
Load regulation *1	$REG_{LOA}$	$V_{IN} = 4.5 \text{ V}$ , $I_{OUT} = 0 \text{ mA} \rightarrow 150 \text{ mA}$	—	50	150	mV
Peak output current *2	$I_{PEAK}$	$V_{IN} = 4.5 \text{ V}$ , The output current value when $V_{OUT}$ decreases by 5% from its value at $I_{OUT} = 50 \text{ mA}$ .	180	240	—	mA
Bias current under no load	$I_{BIAS}$	$V_{IN} = 4.5 \text{ V}$ , $I_{OUT} = 0 \text{ mA}$	—	—	350	$\mu\text{A}$
Bias current fluctuation to load	$\Delta I_{BIAS}$	$V_{IN} = 4.5 \text{ V}$ , $I_{OUT} = 0 \text{ mA} \rightarrow 150 \text{ mA}$	—	—	5	mA
Standby consumption current	$I_{STB}$	$V_{IN} = 10 \text{ V}$ , $V_{CONT} = 0 \text{ V}$	—	—	0.1	$\mu\text{A}$
Bias current before starting regulation	$I_{RUSH}$	$V_{IN} = 3.2 \text{ V}$ , $I_{OUT} = 0 \text{ mA}$	—	1.5	5	mA
Ripple rejection ratio	RR	1 V[rms], $f = 120 \text{ Hz}$ , $I_{OUT} = 10 \text{ mA}$	58	66	—	dB
Minimum input/output voltage difference 1	$V_{DIF(min)1}$	$V_{IN} = 3.2 \text{ V}$ , $I_{OUT} = 0 \text{ mA}$	—	0.1	0.2	V
Minimum input/output voltage difference 2	$V_{DIF(min)2}$	$V_{IN} = 3.6 \text{ V}$ , $I_{OUT} = 150 \text{ mA}$	—	—	0.4	V
Control terminal threshold high voltage	$V_{CONTH}$	$V_{IN} = 4.5 \text{ V}$ , $I_{OUT} = 50 \text{ mA}$	—	—	1.50	V
Control terminal threshold low voltage	$V_{CONTL}$	$V_{IN} = 4.5 \text{ V}$ , $I_{OUT} = 50 \text{ mA}$	0.30	—	—	V
Control terminal current	$I_{CONT}$	$V_{IN} = 4.5 \text{ V}$ , $I_{OUT} = 50 \text{ mA}$ $V_{CONT} = 1.8 \text{ V}$	—	—	30	$\mu\text{A}$

Note) \*1:  $1.0 \Omega$

\*2: Peak output current: The output current when the output voltage has been decreased by 5% from the value at the time when the output current is 50 mA due to the overcurrent protection.

#### • Design reference data

Note) The following values are typical and not guaranteed values.

Parameter	Symbol	Conditions	Min	Typ	Max	Unit
Output noise voltage	$V_{NO}$	$10 \text{ Hz} \leq f \leq 100 \text{ kHz}$ , $I_{OUT} = 10 \text{ mA}$	—	72	—	$\mu\text{V}$
Output voltage temperature coefficient	$\frac{1}{V_{OUT}} \cdot \frac{dV_{OUT}}{dT}$	$V_{IN} = 4.5 \text{ V}$ , $I_{OUT} = 0 \text{ mA}$ $-30^\circ\text{C} \leq T_a \leq +85^\circ\text{C}$	—	90	—	ppm/ $^\circ\text{C}$
Output rise time *	$t_{ON}$	$V_{IN} = 4.5 \text{ V}$ , $I_{OUT} = 50 \text{ mA}$ $V_{CONT} = 0 \text{ V} \rightarrow 1.8 \text{ V}$ , $C_{IN} = 0.1 \mu\text{F}$ $C_{OUT} = 10 \mu\text{F}$ , $V_{OUT} = 90\%$	—	0.12	—	ms

Note) \*: Refer to "■ Application Notes 3. Output rise-time characteristics".

### ■ Electrical Characteristics at $T_a = 25^\circ\text{C}$ (continued)

#### • AN80L36RMS (3.6 V type)

Unless otherwise specially provided, shorten each test time (within 10 ms) so that the test is conducted under the condition that the drift due to the temperature increase in the chip junction part can be neglected.  $C_{IN} = 0.1 \mu\text{F}$ ,  $C_{OUT} = 10 \mu\text{F}$

Parameter	Symbol	Conditions	Min	Typ	Max	Unit
Output voltage	$V_{OUT}$	$V_{IN} = 4.6 \text{ V}$ , $I_{OUT} = 50 \text{ mA}$	3.492	3.6	3.708	V
Line regulation 1	$REG_{IN1}$	$V_{IN} = 4.6 \text{ V} \rightarrow 14.5 \text{ V}$ , $I_{OUT} = 50 \text{ mA}$	—	10	50	mV
Line regulation 2	$REG_{IN2}$	$V_{IN} = 4.6 \text{ V} \rightarrow 9 \text{ V}$ , $I_{OUT} = 50 \text{ mA}$	—	5	20	mV
Load regulation *1	$REG_{LOA}$	$V_{IN} = 4.6 \text{ V}$ , $I_{OUT} = 0 \text{ mA} \rightarrow 150 \text{ mA}$	—	50	150	mV
Peak output current *2	$I_{PEAK}$	$V_{IN} = 4.6 \text{ V}$ , The output current value when $V_{OUT}$ decreases by 5% from its value at $I_{OUT} = 50 \text{ mA}$ .	180	240	—	mA
Bias current under no load	$I_{BIAS}$	$V_{IN} = 4.6 \text{ V}$ , $I_{OUT} = 0 \text{ mA}$	—	—	350	$\mu\text{A}$
Bias current fluctuation to load	$\Delta I_{BIAS}$	$V_{IN} = 4.6 \text{ V}$ , $I_{OUT} = 0 \text{ mA} \rightarrow 150 \text{ mA}$	—	—	5	mA
Standby consumption current	$I_{STB}$	$V_{IN} = 10 \text{ V}$ , $V_{CONT} = 0 \text{ V}$	—	—	0.1	$\mu\text{A}$
Bias current before starting regulation	$I_{RUSH}$	$V_{IN} = 3.3 \text{ V}$ , $I_{OUT} = 0 \text{ mA}$	—	1.5	5	mA
Ripple rejection ratio	RR	1 V[rms], $f = 120 \text{ Hz}$ , $I_{OUT} = 10 \text{ mA}$	58	66	—	dB
Minimum input/output voltage difference 1	$V_{DIF(min)1}$	$V_{IN} = 3.3 \text{ V}$ , $I_{OUT} = 0 \text{ mA}$	—	0.1	0.2	V
Minimum input/output voltage difference 2	$V_{DIF(min)2}$	$V_{IN} = 3.7 \text{ V}$ , $I_{OUT} = 150 \text{ mA}$	—	—	0.4	V
Control terminal threshold high voltage	$V_{CONTH}$	$V_{IN} = 4.6 \text{ V}$ , $I_{OUT} = 50 \text{ mA}$	—	—	1.50	V
Control terminal threshold low voltage	$V_{CONTL}$	$V_{IN} = 4.6 \text{ V}$ , $I_{OUT} = 50 \text{ mA}$	0.30	—	—	V
Control terminal current	$I_{CONT}$	$V_{IN} = 4.6 \text{ V}$ , $I_{OUT} = 50 \text{ mA}$ $V_{CONT} = 1.8 \text{ V}$	—	—	30	$\mu\text{A}$

Note) \*1:  $1.0 \Omega$

\*2: Peak output current: The output current when the output voltage has been decreased by 5% from the value at the time when the output current is 50 mA due to the overcurrent protection.

#### • Design reference data

Note) The following values are typical and not guaranteed values.

Parameter	Symbol	Conditions	Min	Typ	Max	Unit
Output noise voltage	$V_{NO}$	$10 \text{ Hz} \leq f \leq 100 \text{ kHz}$ , $I_{OUT} = 10 \text{ mA}$	—	74	—	$\mu\text{V}$
Output voltage temperature coefficient	$\frac{1}{V_{OUT}} \cdot \frac{dV_{OUT}}{dT}$	$V_{IN} = 4.6 \text{ V}$ , $I_{OUT} = 0 \text{ mA}$ $-30^\circ\text{C} \leq T_a \leq +85^\circ\text{C}$	—	90	—	ppm/ $^\circ\text{C}$
Output rise time *	$t_{ON}$	$V_{IN} = 4.6 \text{ V}$ , $I_{OUT} = 50 \text{ mA}$ $V_{CONT} = 0 \text{ V} \rightarrow 1.8 \text{ V}$ , $C_{IN} = 0.1 \mu\text{F}$ $C_{OUT} = 10 \mu\text{F}$ , $V_{OUT} = 90\%$	—	0.12	—	ms

Note) \*: Refer to "■ Application Notes 3. Output rise-time characteristics".

### ■ Electrical Characteristics at $T_a = 25^\circ\text{C}$ (continued)

#### • AN80L48RMS (4.8 V type)

Unless otherwise specially provided, shorten each test time (within 10 ms) so that the test is conducted under the condition that the drift due to the temperature increase in the chip junction part can be neglected.  $C_{IN} = 0.1 \mu\text{F}$ ,  $C_{OUT} = 10 \mu\text{F}$

Parameter	Symbol	Conditions	Min	Typ	Max	Unit
Output voltage	$V_{OUT}$	$V_{IN} = 5.8 \text{ V}$ , $I_{OUT} = 50 \text{ mA}$	4.656	4.8	4.944	V
Line regulation 1	$REG_{IN1}$	$V_{IN} = 5.8 \text{ V} \rightarrow 14.5 \text{ V}$ , $I_{OUT} = 50 \text{ mA}$	—	10	50	mV
Line regulation 2	$REG_{IN2}$	$V_{IN} = 5.8 \text{ V} \rightarrow 9 \text{ V}$ , $I_{OUT} = 50 \text{ mA}$	—	5	20	mV
Load regulation *1	$REG_{LOA}$	$V_{IN} = 5.8 \text{ V}$ , $I_{OUT} = 0 \text{ mA} \rightarrow 150 \text{ mA}$	—	50	150	mV
Peak output current *2	$I_{PEAK}$	$V_{IN} = 5.8 \text{ V}$ , The output current value when $V_{OUT}$ decreases by 5% from its value at $I_{OUT} = 50 \text{ mA}$ .	180	240	—	mA
Bias current under no load	$I_{BIAS}$	$V_{IN} = 5.8 \text{ V}$ , $I_{OUT} = 0 \text{ mA}$	—	—	350	$\mu\text{A}$
Bias current fluctuation to load	$\Delta I_{BIAS}$	$V_{IN} = 5.8 \text{ V}$ , $I_{OUT} = 0 \text{ mA} \rightarrow 150 \text{ mA}$	—	—	5	mA
Standby consumption current	$I_{STB}$	$V_{IN} = 10 \text{ V}$ , $V_{CONT} = 0 \text{ V}$	—	—	0.1	$\mu\text{A}$
Bias current before starting regulation	$I_{RUSH}$	$V_{IN} = 4.5 \text{ V}$ , $I_{OUT} = 0 \text{ mA}$	—	1.5	5	mA
Ripple rejection ratio	RR	1 V[rms], $f = 120 \text{ Hz}$ , $I_{OUT} = 10 \text{ mA}$	57	65	—	dB
Minimum input/output voltage difference 1	$V_{DIF(min)1}$	$V_{IN} = 4.5 \text{ V}$ , $I_{OUT} = 0 \text{ mA}$	—	0.1	0.2	V
Minimum input/output voltage difference 2	$V_{DIF(min)2}$	$V_{IN} = 4.9 \text{ V}$ , $I_{OUT} = 150 \text{ mA}$	—	—	0.4	V
Control terminal threshold high voltage	$V_{CONTH}$	$V_{IN} = 5.8 \text{ V}$ , $I_{OUT} = 50 \text{ mA}$	—	—	1.50	V
Control terminal threshold low voltage	$V_{CONTL}$	$V_{IN} = 5.8 \text{ V}$ , $I_{OUT} = 50 \text{ mA}$	0.30	—	—	V
Control terminal current	$I_{CONT}$	$V_{IN} = 5.8 \text{ V}$ , $I_{OUT} = 50 \text{ mA}$ $V_{CONT} = 1.8 \text{ V}$	—	—	30	$\mu\text{A}$

Note) \*1:  $1.0 \Omega$

\*2: Peak output current: The output current when the output voltage has been decreased by 5% from the value at the time when the output current is 50 mA due to the overcurrent protection.

#### • Design reference data

Note) The following values are typical and not guaranteed values.

Parameter	Symbol	Conditions	Min	Typ	Max	Unit
Output noise voltage	$V_{NO}$	$10 \text{ Hz} \leq f \leq 100 \text{ kHz}$ , $I_{OUT} = 10 \text{ mA}$	—	100	—	$\mu\text{V}$
Output voltage temperature coefficient	$\frac{1}{V_{OUT}} \cdot \frac{dV_{OUT}}{dT}$	$V_{IN} = 5.8 \text{ V}$ , $I_{OUT} = 0 \text{ mA}$ $-30^\circ\text{C} \leq T_a \leq +85^\circ\text{C}$	—	90	—	ppm/ $^\circ\text{C}$
Output rise time *	$t_{ON}$	$V_{IN} = 5.8 \text{ V}$ , $I_{OUT} = 50 \text{ mA}$ $V_{CONT} = 0 \text{ V} \rightarrow 1.8 \text{ V}$ , $C_{IN} = 0.1 \mu\text{F}$ $C_{OUT} = 10 \mu\text{F}$ , $V_{OUT} = 90\%$	—	0.20	—	ms

Note) \*: Refer to "■ Application Notes 3. Output rise-time characteristics".

### ■ Electrical Characteristics at $T_a = 25^\circ\text{C}$ (continued)

#### • AN80L49RMS (4.9 V type)

Unless otherwise specially provided, shorten each test time (within 10 ms) so that the test is conducted under the condition that the drift due to the temperature increase in the chip junction part can be neglected.  $C_{IN} = 0.1 \mu\text{F}$ ,  $C_{OUT} = 10 \mu\text{F}$

Parameter	Symbol	Conditions	Min	Typ	Max	Unit
Output voltage	$V_{OUT}$	$V_{IN} = 5.9 \text{ V}$ , $I_{OUT} = 50 \text{ mA}$	4.753	4.9	5.047	V
Line regulation 1	$REG_{IN1}$	$V_{IN} = 5.9 \text{ V} \rightarrow 14.5 \text{ V}$ , $I_{OUT} = 50 \text{ mA}$	—	10	50	mV
Line regulation 2	$REG_{IN2}$	$V_{IN} = 5.9 \text{ V} \rightarrow 9 \text{ V}$ , $I_{OUT} = 50 \text{ mA}$	—	5	20	mV
Load regulation *1	$REG_{LOA}$	$V_{IN} = 5.9 \text{ V}$ , $I_{OUT} = 0 \text{ mA} \rightarrow 150 \text{ mA}$	—	50	150	mV
Peak output current *2	$I_{PEAK}$	$V_{IN} = 5.9 \text{ V}$ , The output current value when $V_{OUT}$ decreases by 5% from its value at $I_{OUT} = 50 \text{ mA}$ .	180	240	—	mA
Bias current under no load	$I_{BIAS}$	$V_{IN} = 5.9 \text{ V}$ , $I_{OUT} = 0 \text{ mA}$	—	—	350	$\mu\text{A}$
Bias current fluctuation to load	$\Delta I_{BIAS}$	$V_{IN} = 5.9 \text{ V}$ , $I_{OUT} = 0 \text{ mA} \rightarrow 150 \text{ mA}$	—	—	5	mA
Standby consumption current	$I_{STB}$	$V_{IN} = 10 \text{ V}$ , $V_{CONT} = 0 \text{ V}$	—	—	0.1	$\mu\text{A}$
Bias current before starting regulation	$I_{RUSH}$	$V_{IN} = 4.6 \text{ V}$ , $I_{OUT} = 0 \text{ mA}$	—	1.5	5	mA
Ripple rejection ratio	RR	1 V[rms], $f = 120 \text{ Hz}$ , $I_{OUT} = 10 \text{ mA}$	57	65	—	dB
Minimum input/output voltage difference 1	$V_{DIF(min)1}$	$V_{IN} = 4.6 \text{ V}$ , $I_{OUT} = 0 \text{ mA}$	—	0.1	0.2	V
Minimum input/output voltage difference 2	$V_{DIF(min)2}$	$V_{IN} = 5.0 \text{ V}$ , $I_{OUT} = 150 \text{ mA}$	—	—	0.4	V
Control terminal threshold high voltage	$V_{CONTH}$	$V_{IN} = 5.9 \text{ V}$ , $I_{OUT} = 50 \text{ mA}$	—	—	1.50	V
Control terminal threshold low voltage	$V_{CONTL}$	$V_{IN} = 5.9 \text{ V}$ , $I_{OUT} = 50 \text{ mA}$	0.30	—	—	V
Control terminal current	$I_{CONT}$	$V_{IN} = 5.9 \text{ V}$ , $I_{OUT} = 50 \text{ mA}$ $V_{CONT} = 1.8 \text{ V}$	—	—	30	$\mu\text{A}$

Note) \*1:  $1.0 \Omega$

\*2: Peak output current: The output current when the output voltage has been decreased by 5% from the value at the time when the output current is 50 mA due to the overcurrent protection.

#### • Design reference data

Note) The following values are typical and not guaranteed values.

Parameter	Symbol	Conditions	Min	Typ	Max	Unit
Output noise voltage	$V_{NO}$	$10 \text{ Hz} \leq f \leq 100 \text{ kHz}$ , $I_{OUT} = 10 \text{ mA}$	—	102	—	$\mu\text{V}$
Output voltage temperature coefficient	$\frac{1}{V_{OUT}} \cdot \frac{dV_{OUT}}{dT}$	$V_{IN} = 5.9 \text{ V}$ , $I_{OUT} = 0 \text{ mA}$ $-30^\circ\text{C} \leq T_a \leq +85^\circ\text{C}$	—	90	—	ppm/ $^\circ\text{C}$
Output rise time *	$t_{ON}$	$V_{IN} = 5.9 \text{ V}$ , $I_{OUT} = 50 \text{ mA}$ $V_{CONT} = 0 \text{ V} \rightarrow 1.8 \text{ V}$ , $C_{IN} = 0.1 \mu\text{F}$ $C_{OUT} = 10 \mu\text{F}$ , $V_{OUT} = 90\%$	—	0.20	—	ms

Note) \*: Refer to "■ Application Notes 3. Output rise-time characteristics".

### ■ Electrical Characteristics at $T_a = 25^\circ\text{C}$ (continued)

#### • AN80L50RMS (5.0 V type)

Unless otherwise specially provided, shorten each test time (within 10 ms) so that the test is conducted under the condition that the drift due to the temperature increase in the chip junction part can be neglected.  $C_{IN} = 0.1 \mu\text{F}$ ,  $C_{OUT} = 10 \mu\text{F}$

Parameter	Symbol	Conditions	Min	Typ	Max	Unit
Output voltage	$V_{OUT}$	$V_{IN} = 6.0 \text{ V}$ , $I_{OUT} = 50 \text{ mA}$	4.850	5.0	5.150	V
Line regulation 1	$REG_{IN1}$	$V_{IN} = 6.0 \text{ V} \rightarrow 14.5 \text{ V}$ , $I_{OUT} = 50 \text{ mA}$	—	10	50	mV
Line regulation 2	$REG_{IN2}$	$V_{IN} = 6.0 \text{ V} \rightarrow 9 \text{ V}$ , $I_{OUT} = 50 \text{ mA}$	—	5	20	mV
Load regulation *1	$REG_{LOA}$	$V_{IN} = 6.0 \text{ V}$ , $I_{OUT} = 0 \text{ mA} \rightarrow 150 \text{ mA}$	—	50	150	mV
Peak output current *2	$I_{PEAK}$	$V_{IN} = 6.0 \text{ V}$ , The output current value when $V_{OUT}$ decreases by 5% from its value at $I_{OUT} = 50 \text{ mA}$ .	180	240	—	mA
Bias current under no load	$I_{BIAS}$	$V_{IN} = 6.0 \text{ V}$ , $I_{OUT} = 0 \text{ mA}$	—	—	350	$\mu\text{A}$
Bias current fluctuation to load	$\Delta I_{BIAS}$	$V_{IN} = 6.0 \text{ V}$ , $I_{OUT} = 0 \text{ mA} \rightarrow 150 \text{ mA}$	—	—	5	mA
Standby consumption current	$I_{STB}$	$V_{IN} = 10 \text{ V}$ , $V_{CONT} = 0 \text{ V}$	—	—	0.1	$\mu\text{A}$
Bias current before starting regulation	$I_{RUSH}$	$V_{IN} = 4.7 \text{ V}$ , $I_{OUT} = 0 \text{ mA}$	—	1.5	5	mA
Ripple rejection ratio	RR	1 V[rms], $f = 120 \text{ Hz}$ , $I_{OUT} = 10 \text{ mA}$	56	64	—	dB
Minimum input/output voltage difference 1	$V_{DIF(min)1}$	$V_{IN} = 4.7 \text{ V}$ , $I_{OUT} = 0 \text{ mA}$	—	0.1	0.2	V
Minimum input/output voltage difference 2	$V_{DIF(min)2}$	$V_{IN} = 5.1 \text{ V}$ , $I_{OUT} = 150 \text{ mA}$	—	—	0.4	V
Control terminal threshold high voltage	$V_{CONTH}$	$V_{IN} = 6.0 \text{ V}$ , $I_{OUT} = 50 \text{ mA}$	—	—	1.50	V
Control terminal threshold low voltage	$V_{CONTL}$	$V_{IN} = 6.0 \text{ V}$ , $I_{OUT} = 50 \text{ mA}$	0.30	—	—	V
Control terminal current	$I_{CONT}$	$V_{IN} = 6.0 \text{ V}$ , $I_{OUT} = 50 \text{ mA}$ $V_{CONT} = 1.8 \text{ V}$	—	—	30	$\mu\text{A}$

Note) \*1:  $1.0 \Omega$

\*2: Peak output current: The output current when the output voltage has been decreased by 5% from the value at the time when the output current is 50 mA due to the overcurrent protection.

#### • Design reference data

Note) The following values are typical and not guaranteed values.

Parameter	Symbol	Conditions	Min	Typ	Max	Unit
Output noise voltage	$V_{NO}$	$10 \text{ Hz} \leq f \leq 100 \text{ kHz}$ , $I_{OUT} = 10 \text{ mA}$	—	104	—	$\mu\text{V}$
Output voltage temperature coefficient	$\frac{1}{V_{OUT}} \cdot \frac{dV_{OUT}}{dT}$	$V_{IN} = 6.0 \text{ V}$ , $I_{OUT} = 0 \text{ mA}$ $-30^\circ\text{C} \leq T_a \leq +85^\circ\text{C}$	—	90	—	ppm/ $^\circ\text{C}$
Output rise time *	$t_{ON}$	$V_{IN} = 6.0 \text{ V}$ , $I_{OUT} = 50 \text{ mA}$ $V_{CONT} = 0 \text{ V} \rightarrow 1.8 \text{ V}$ , $C_{IN} = 0.1 \mu\text{F}$ $C_{OUT} = 10 \mu\text{F}$ , $V_{OUT} = 90\%$	—	0.20	—	ms

Note) \*: Refer to "■ Application Notes 3. Output rise-time characteristics".

### ■ Electrical Characteristics at $T_a = 25^\circ\text{C}$ (continued)

#### • AN80L51RMS (5.1 V type)

Unless otherwise specially provided, shorten each test time (within 10 ms) so that the test is conducted under the condition that the drift due to the temperature increase in the chip junction part can be neglected.  $C_{IN} = 0.1 \mu\text{F}$ ,  $C_{OUT} = 10 \mu\text{F}$

Parameter	Symbol	Conditions	Min	Typ	Max	Unit
Output voltage	$V_{OUT}$	$V_{IN} = 6.1 \text{ V}$ , $I_{OUT} = 50 \text{ mA}$	4.947	5.1	5.253	V
Line regulation 1	$REG_{IN1}$	$V_{IN} = 6.1 \text{ V} \rightarrow 14.5 \text{ V}$ , $I_{OUT} = 50 \text{ mA}$	—	10	50	mV
Line regulation 2	$REG_{IN2}$	$V_{IN} = 6.1 \text{ V} \rightarrow 9 \text{ V}$ , $I_{OUT} = 50 \text{ mA}$	—	5	20	mV
Load regulation *1	$REG_{LOA}$	$V_{IN} = 6.1 \text{ V}$ , $I_{OUT} = 0 \text{ mA} \rightarrow 150 \text{ mA}$	—	50	150	mV
Peak output current *2	$I_{PEAK}$	$V_{IN} = 6.1 \text{ V}$ , The output current value when $V_{OUT}$ decreases by 5% from its value at $I_{OUT} = 50 \text{ mA}$ .	180	240	—	mA
Bias current under no load	$I_{BIAS}$	$V_{IN} = 6.1 \text{ V}$ , $I_{OUT} = 0 \text{ mA}$	—	—	350	$\mu\text{A}$
Bias current fluctuation to load	$\Delta I_{BIAS}$	$V_{IN} = 6.1 \text{ V}$ , $I_{OUT} = 0 \text{ mA} \rightarrow 150 \text{ mA}$	—	—	5	mA
Standby consumption current	$I_{STB}$	$V_{IN} = 10 \text{ V}$ , $V_{CONT} = 0 \text{ V}$	—	—	0.1	$\mu\text{A}$
Bias current before starting regulation	$I_{RUSH}$	$V_{IN} = 4.8 \text{ V}$ , $I_{OUT} = 0 \text{ mA}$	—	1.5	5	mA
Ripple rejection ratio	RR	1 V[rms], $f = 120 \text{ Hz}$ , $I_{OUT} = 10 \text{ mA}$	56	64	—	dB
Minimum input/output voltage difference 1	$V_{DIF(min)1}$	$V_{IN} = 4.8 \text{ V}$ , $I_{OUT} = 0 \text{ mA}$	—	0.1	0.2	V
Minimum input/output voltage difference 2	$V_{DIF(min)2}$	$V_{IN} = 5.2 \text{ V}$ , $I_{OUT} = 150 \text{ mA}$	—	—	0.4	V
Control terminal threshold high voltage	$V_{CONTH}$	$V_{IN} = 6.1 \text{ V}$ , $I_{OUT} = 50 \text{ mA}$	—	—	1.50	V
Control terminal threshold low voltage	$V_{CONTL}$	$V_{IN} = 6.1 \text{ V}$ , $I_{OUT} = 50 \text{ mA}$	0.30	—	—	V
Control terminal current	$I_{CONT}$	$V_{IN} = 6.1 \text{ V}$ , $I_{OUT} = 50 \text{ mA}$ $V_{CONT} = 1.8 \text{ V}$	—	—	30	$\mu\text{A}$

Note) \*1:  $1.0 \Omega$

\*2: Peak output current: The output current when the output voltage has been decreased by 5% from the value at the time when the output current is 50 mA due to the overcurrent protection.

#### • Design reference data

Note) The following values are typical and not guaranteed values.

Parameter	Symbol	Conditions	Min	Typ	Max	Unit
Output noise voltage	$V_{NO}$	$10 \text{ Hz} \leq f \leq 100 \text{ kHz}$ , $I_{OUT} = 10 \text{ mA}$	—	106	—	$\mu\text{V}$
Output voltage temperature coefficient	$\frac{1}{V_{OUT}} \cdot \frac{dV_{OUT}}{dT}$	$V_{IN} = 6.1 \text{ V}$ , $I_{OUT} = 0 \text{ mA}$ $-30^\circ\text{C} \leq T_a \leq +85^\circ\text{C}$	—	90	—	ppm/ $^\circ\text{C}$
Output rise time *	$t_{ON}$	$V_{IN} = 6.1 \text{ V}$ , $I_{OUT} = 50 \text{ mA}$ $V_{CONT} = 0 \text{ V} \rightarrow 1.8 \text{ V}$ , $C_{IN} = 0.1 \mu\text{F}$ $C_{OUT} = 10 \mu\text{F}$ , $V_{OUT} = 90\%$	—	0.20	—	ms

Note) \*: Refer to "■ Application Notes 3. Output rise-time characteristics".

### ■ Electrical Characteristics at $T_a = 25^\circ\text{C}$ (continued)

#### • AN80L52RMS (5.2 V type)

Unless otherwise specially provided, shorten each test time (within 10 ms) so that the test is conducted under the condition that the drift due to the temperature increase in the chip junction part can be neglected.  $C_{IN} = 0.1 \mu\text{F}$ ,  $C_{OUT} = 10 \mu\text{F}$

Parameter	Symbol	Conditions	Min	Typ	Max	Unit
Output voltage	$V_{OUT}$	$V_{IN} = 6.2 \text{ V}$ , $I_{OUT} = 50 \text{ mA}$	5.044	5.2	5.356	V
Line regulation 1	$REG_{IN1}$	$V_{IN} = 6.2 \text{ V} \rightarrow 14.5 \text{ V}$ , $I_{OUT} = 50 \text{ mA}$	—	10	50	mV
Line regulation 2	$REG_{IN2}$	$V_{IN} = 6.2 \text{ V} \rightarrow 9 \text{ V}$ , $I_{OUT} = 50 \text{ mA}$	—	5	20	mV
Load regulation *1	$REG_{LOA}$	$V_{IN} = 6.2 \text{ V}$ , $I_{OUT} = 0 \text{ mA} \rightarrow 150 \text{ mA}$	—	50	150	mV
Peak output current *2	$I_{PEAK}$	$V_{IN} = 6.2 \text{ V}$ , The output current value when $V_{OUT}$ decreases by 5% from its value at $I_{OUT} = 50 \text{ mA}$ .	180	240	—	mA
Bias current under no load	$I_{BIAS}$	$V_{IN} = 6.2 \text{ V}$ , $I_{OUT} = 0 \text{ mA}$	—	—	350	$\mu\text{A}$
Bias current fluctuation to load	$\Delta I_{BIAS}$	$V_{IN} = 6.2 \text{ V}$ , $I_{OUT} = 0 \text{ mA} \rightarrow 150 \text{ mA}$	—	—	5	mA
Standby consumption current	$I_{STB}$	$V_{IN} = 10 \text{ V}$ , $V_{CONT} = 0 \text{ V}$	—	—	0.1	$\mu\text{A}$
Bias current before starting regulation	$I_{RUSH}$	$V_{IN} = 4.9 \text{ V}$ , $I_{OUT} = 0 \text{ mA}$	—	1.5	5	mA
Ripple rejection ratio	RR	1 V[rms], $f = 120 \text{ Hz}$ , $I_{OUT} = 10 \text{ mA}$	56	64	—	dB
Minimum input/output voltage difference 1	$V_{DIF(min)1}$	$V_{IN} = 4.9 \text{ V}$ , $I_{OUT} = 0 \text{ mA}$	—	0.1	0.2	V
Minimum input/output voltage difference 2	$V_{DIF(min)2}$	$V_{IN} = 5.3 \text{ V}$ , $I_{OUT} = 150 \text{ mA}$	—	—	0.4	V
Control terminal threshold high voltage	$V_{CONTH}$	$V_{IN} = 6.2 \text{ V}$ , $I_{OUT} = 50 \text{ mA}$	—	—	1.50	V
Control terminal threshold low voltage	$V_{CONTL}$	$V_{IN} = 6.2 \text{ V}$ , $I_{OUT} = 50 \text{ mA}$	0.30	—	—	V
Control terminal current	$I_{CONT}$	$V_{IN} = 6.2 \text{ V}$ , $I_{OUT} = 50 \text{ mA}$ $V_{CONT} = 1.8 \text{ V}$	—	—	30	$\mu\text{A}$

Note) \*1:  $1.0 \Omega$

\*2: Peak output current: The output current when the output voltage has been decreased by 5% from the value at the time when the output current is 50 mA due to the overcurrent protection.

#### • Design reference data

Note) The following values are typical and not guaranteed values.

Parameter	Symbol	Conditions	Min	Typ	Max	Unit
Output noise voltage	$V_{NO}$	$10 \text{ Hz} \leq f \leq 100 \text{ kHz}$ , $I_{OUT} = 10 \text{ mA}$	—	108	—	$\mu\text{V}$
Output voltage temperature coefficient	$\frac{1}{V_{OUT}} \cdot \frac{dV_{OUT}}{dT}$	$V_{IN} = 6.2 \text{ V}$ , $I_{OUT} = 0 \text{ mA}$ $-30^\circ\text{C} \leq T_a \leq +85^\circ\text{C}$	—	90	—	ppm/ $^\circ\text{C}$
Output rise time *	$t_{ON}$	$V_{IN} = 6.2 \text{ V}$ , $I_{OUT} = 50 \text{ mA}$ $V_{CONT} = 0 \text{ V} \rightarrow 1.8 \text{ V}$ , $C_{IN} = 0.1 \mu\text{F}$ $C_{OUT} = 10 \mu\text{F}$ , $V_{OUT} = 90\%$	—	0.20	—	ms

Note) \*: Refer to "■ Application Notes 3. Output rise-time characteristics".

■ Application Notes

1.  $P_D - T_a$  curves of MINI-5D package

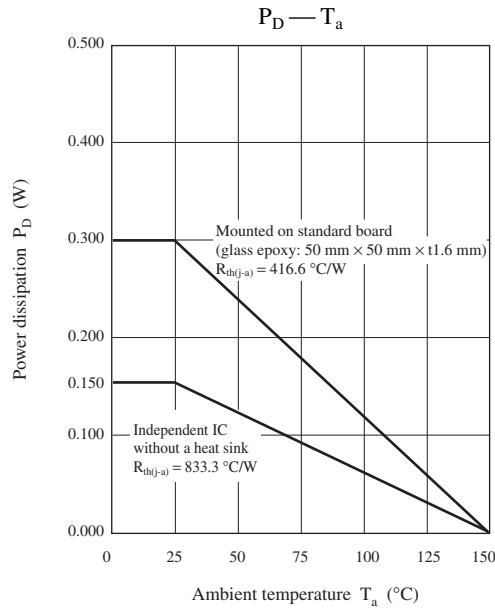

2. ESR characteristics

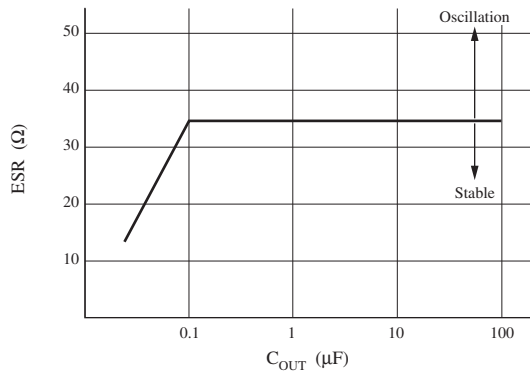

• Test circuit

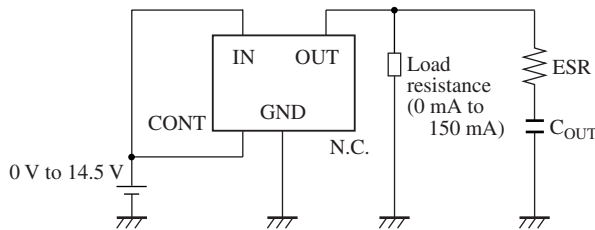

Note) 1. Not guaranteed values.

2. The capacitance value used for  $C_{OUT}$  must be 0.22  $\mu F$  or more and 100  $\mu F$  or less. The recommended value is 10  $\mu F$ .

3. Use a capacitor having ESR (equivalent series resistance of capacitor) of 35  $\Omega$  or less (at  $T_a = -30^\circ C$  to  $+85^\circ C$ ).

■ Application Notes (continued)

3. Output rise-time characteristics

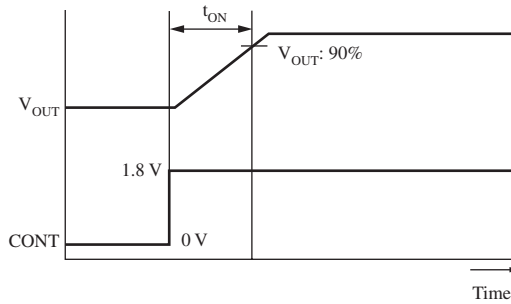

4. Main characteristics

• AN80L18RMS

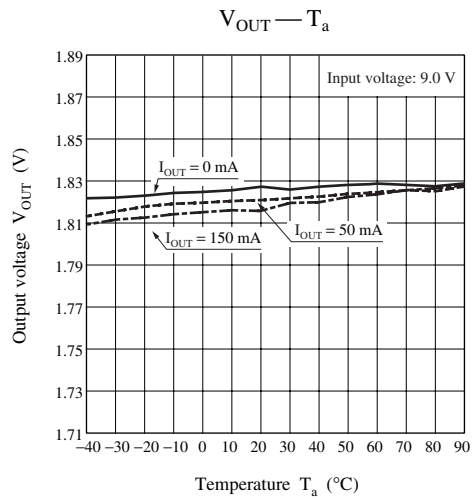
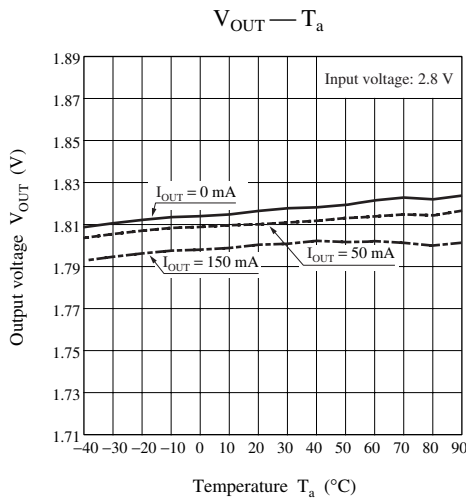

• AN80L20RMS

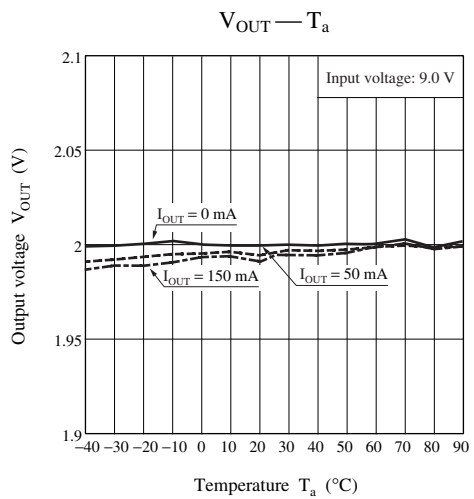
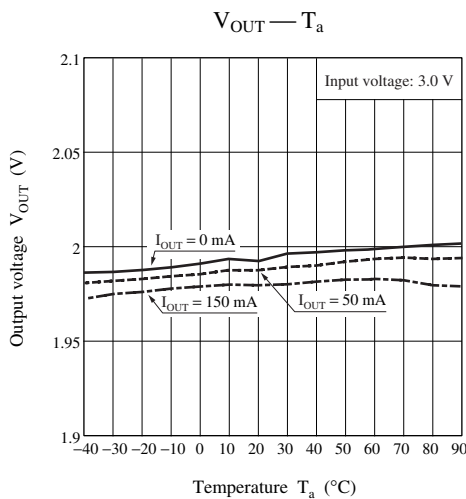

■ Application Notes (continued)

4. Main characteristics (continued)

- AN80L33RMS

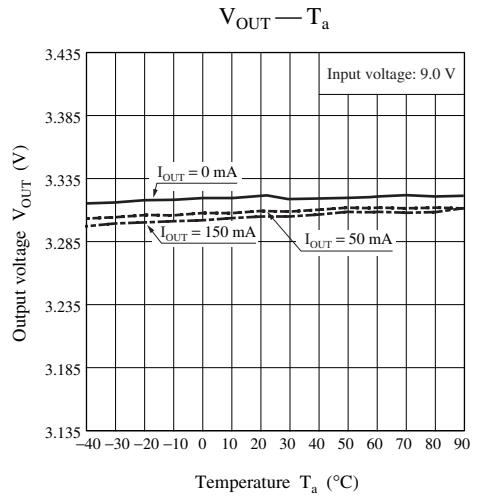
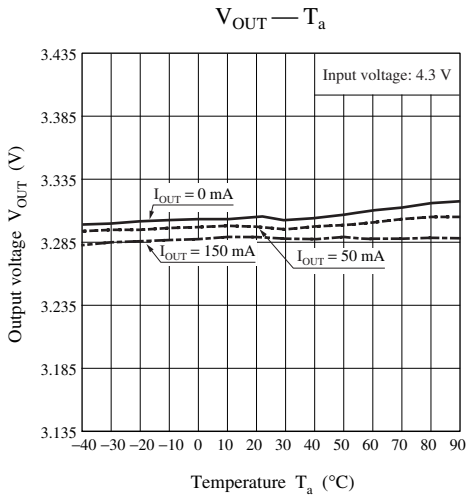

- AN80L36RMS

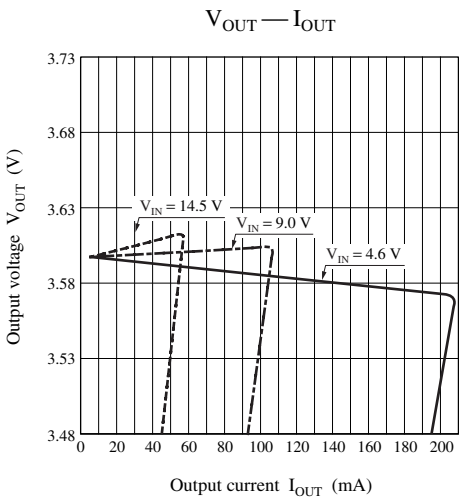

■ Application Circuit Example

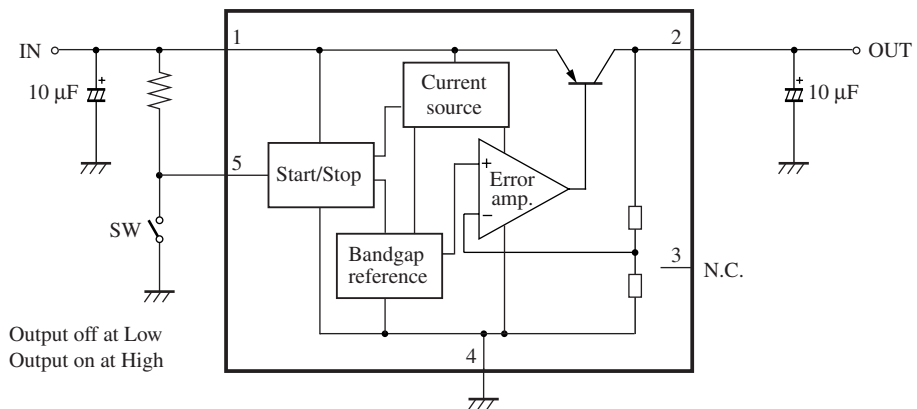

## Request for your special attention and precautions in using the technical information and semiconductors described in this material

- (1) An export permit needs to be obtained from the competent authorities of the Japanese Government if any of the products or technologies described in this material and controlled under the "Foreign Exchange and Foreign Trade Law" is to be exported or taken out of Japan.
- (2) The technical information described in this material is limited to showing representative characteristics and applied circuit examples of the products. It does not constitute the warranting of industrial property, the granting of relative rights, or the granting of any license.
- (3) The products described in this material are intended to be used for standard applications or general electronic equipment (such as office equipment, communications equipment, measuring instruments and household appliances).  
Consult our sales staff in advance for information on the following applications:
  - Special applications (such as for airplanes, aerospace, automobiles, traffic control equipment, combustion equipment, life support systems and safety devices) in which exceptional quality and reliability are required, or if the failure or malfunction of the products may directly jeopardize life or harm the human body.
  - Any applications other than the standard applications intended.
- (4) The products and product specifications described in this material are subject to change without notice for reasons of modification and/or improvement. At the final stage of your design, purchasing, or use of the products, therefore, ask for the most up-to-date Product Standards in advance to make sure that the latest specifications satisfy your requirements.
- (5) When designing your equipment, comply with the guaranteed values, in particular those of maximum rating, the range of operating power supply voltage and heat radiation characteristics. Otherwise, we will not be liable for any defect which may arise later in your equipment.  
Even when the products are used within the guaranteed values, redundant design is recommended, so that such equipment may not violate relevant laws or regulations because of the function of our products.
- (6) When using products for which dry packing is required, observe the conditions (including shelf life and after-unpacking standby time) agreed upon when specification sheets are individually exchanged.
- (7) No part of this material may be reprinted or reproduced by any means without written permission from our company.

## Please read the following notes before using the datasheets

- A. These materials are intended as a reference to assist customers with the selection of Panasonic semiconductor products best suited to their applications.  
Due to modification or other reasons, any information contained in this material, such as available product types, technical data, and so on, is subject to change without notice.  
Customers are advised to contact our semiconductor sales office and obtain the latest information before starting precise technical research and/or purchasing activities.
- B. Panasonic is endeavoring to continually improve the quality and reliability of these materials but there is always the possibility that further rectifications will be required in the future. Therefore, Panasonic will not assume any liability for any damages arising from any errors etc. that may appear in this material.
- C. These materials are solely intended for a customer's individual use.  
Therefore, without the prior written approval of Panasonic, any other use such as reproducing, selling, or distributing this material to a third party, via the Internet or in any other way, is prohibited.



LittleDiode supplies new, hard to find or obsolete electronic components and semiconductors all over the world.

With over two million different components listed you are sure to find the part you need.

Feel free to visit us today at our online store:

**[LittleDiode.com](http://LittleDiode.com)**

Looking forward to providing you with the best possible service.