

# AN8001FHK

## Gradation voltage generation IC for liquid crystal display

### ■ Overview

The AN8001FHK is a gradation voltage generation IC for liquid crystal displays and designed for 64-gradation LCDs. It is incorporating an 1.23 V reference voltage circuit, 10 gradation output buffer amplifier circuits, and a COM amplifier circuit.

### ■ Features

- Incorporating a high precision reference voltage source: 1.23 V (typ.)
- Wide dynamic range of buffer amplifiers and it is possible to provide an output from  $V_{CC} - 0.2$  V (the highest stage) to GND + 0.2 V (the lowest stage).
- Large COM-amplifier drive current:  $\pm 100$  mA (max.)

### ■ Applications

- Gradation power supply source for LCDs

### ■ Block Diagram

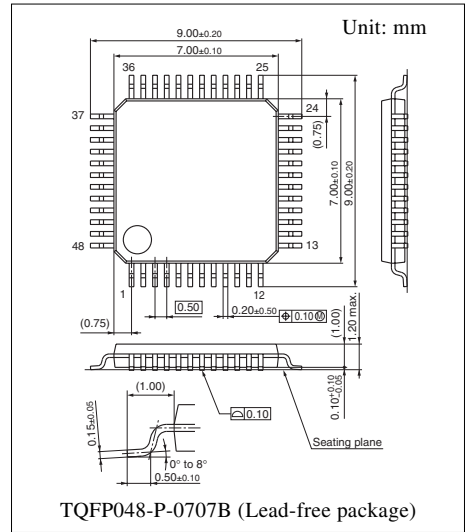
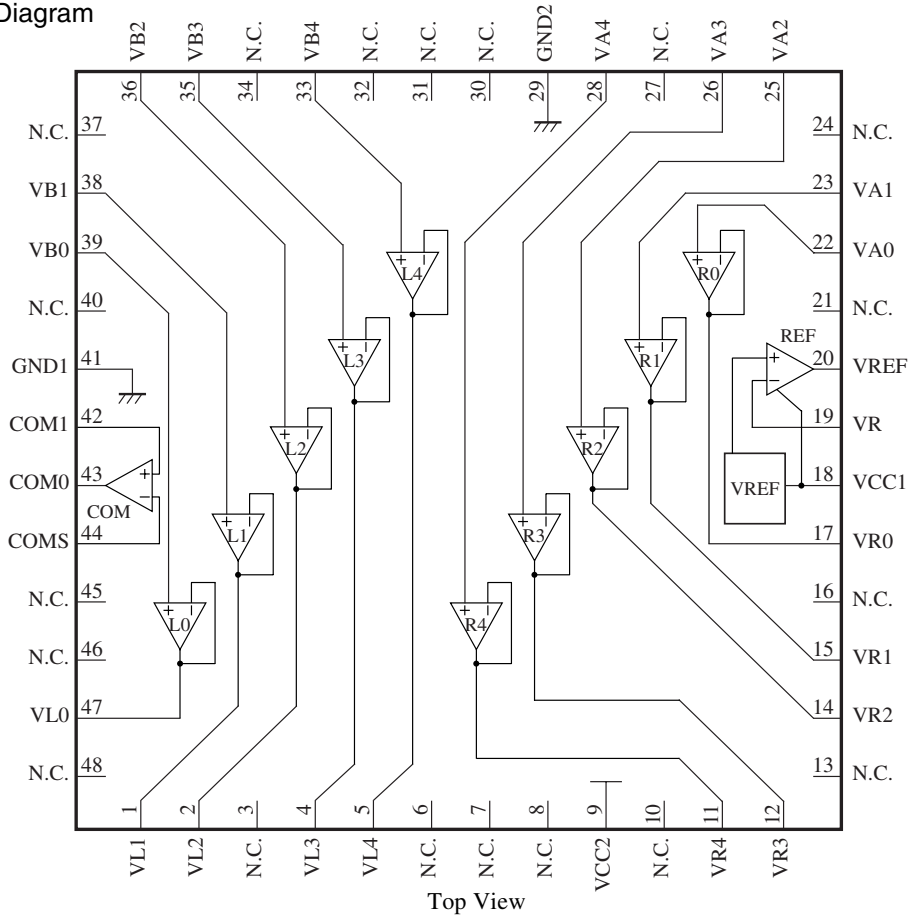

### ■ Absolute Maximum Ratings

Parameter	Symbol	Rating	Unit
Supply voltage	$V_{CC}$	14.2	V
Supply current	$I_{CC}$	—	mA
REF amplifier output source current	$I_{Osource}$	-5	mA
R0 amplifier output source current	$I_{O-R0}$	-15	mA
R0 amplifier output sink current	$I_{O+R0}$	0.1	mA
R1 amplifier output source current	$I_{O-R1}$	-15	mA
R1 amplifier output sink current	$I_{O+R1}$	0.1	mA
R/2/3/4, L2/3/4 amplifier output source current	$I_{O-R2-L2}$	-15	mA
R/2/3/4, L2/3/4 amplifier output sink current	$I_{O+R2-L2}$	15	mA
L1 amplifier output source current	$I_{O-L1}$	-0.05	mA
L1 amplifier output sink current	$I_{O+L1}$	15	mA
L0 amplifier output source current	$I_{O-L0}$	-0.05	mA
L0 amplifier output sink current	$I_{O+L0}$	15	mA
COM amplifier output source current	$I_{O-COM}$	-100	mA
COM amplifier output sink current	$I_{O+COM}$	100	mA
Power dissipation	$P_D$	400* <sup>2</sup> 220* <sup>3</sup>	mW
Operating ambient temperature* <sup>1</sup>	$T_{opr}$	0 to +70	°C
Storage temperature* <sup>1</sup>	$T_{stg}$	-55 to +150	°C
REF amplifier maximum load capacitance	$C_{OREF}$	0.47	mF
R0/1/2/3/4, L4/3/2/1/0 amplifier maximum load capacitance	$C_{OR/L}$	0.1	μF
COM amplifier maximum load capacitance	$C_{OCOM}$	10	μF

Note) Either current or voltage should not be applied from the outside to any terminals not specified.

For the circuit current, (+) is current flowing into the IC and (-) is current flowing out of the IC.

Set the input voltage of each amplifier within the range of the output voltage.

\*1 : All items are at  $T_a = 25^\circ\text{C}$ , except for the operating ambient temperature and storage temperature parameters.

\*2 :  $T_a = 25^\circ\text{C}$

\*3 :  $T_a = 70^\circ\text{C}$

### ■ Recommended Operating Range

Parameter	Symbol	Range	Unit
Supply voltage	$V_{CC}$	7 to 14	V

**■ Electrical Characteristics at  $T_a = 25^\circ\text{C}$** 

Parameter	Symbol	Conditions	Min	Typ	Max	Unit
All device						
Circuit current	$I_{CC}$		—	3.5	6	mA
Reference voltage	$V_{REF}$		1.19	1.23	1.27	V
Input bias current	$I_B$		—	—	500	nA
REF amplifier block						
Operating upper limit voltage 1	$V_{H1}$	Discharge current : 2 mA Connect 0.1 $\mu\text{F}$ or more for oscillation prevention	$V_{CC}$ - 0.2 V	—	—	V
Operating upper limit voltage 2	$V_{H2}$	Discharge current : 3 mA Connect 0.1 $\mu\text{F}$ or more for oscillation prevention	$V_{CC}$ - 0.3 V	—	—	V
Operating lower limit voltage	$V_L$	Connect 0.1 $\mu\text{F}$ or more for oscillation prevention	—	—	$V_{REF}$	V
R0 amplifier block						
Output upper limit voltage 1	$V_{H,R01}$	Discharge current : 10 mA	$V_{CC}$ - 0.2 V	—	—	V
Output upper limit voltage 2	$V_{H,R02}$	Discharge current : 15 mA	$V_{CC}$ - 0.25V	—	—	V
Output lower limit voltage	$V_{L,R0}$	Sink current : 0.1 mA	—	—	$V_{CC}$ - 3 V	V
Offset voltage	$V_{OFFR0}$		—	—	10	mV
R1 amplifier block						
Output upper limit voltage	$V_{H,R1}$	Discharge current : 15 mA	$V_{CC}$ - 0.7 V	—	—	V
Output lower limit voltage	$V_{L,R1}$	Sink current : 0.1 mA	—	—	$V_{CC}/2$	V
Offset voltage	$V_{OFFR1}$		—	—	10	mV
R2/R3/R4/L2/L3/L4 amplifier block						
Output upper limit voltage 1	$V_{H,R2-R4}$	Discharge current : 15 mA	$V_{CC}$ - 1.5 V	—	—	V
Output lower limit voltage 1	$V_{L,R2-R4}$	Sink current : 15 mA	—	—	2	V
Output upper limit voltage 2	$V_{H,L2-L4}$	Discharge current : 15 mA	$V_{CC}$ - 2 V	—	—	V
Output lower limit voltage 2	$V_{L,L2-L4}$	Sink current : 15 mA	—	—	1.5	V
Offset voltage	$V_{OFF234}$		—	—	10	mV
L1 amplifier block						
Output upper limit voltage	$V_{H,L1}$	Discharge current : 50 $\mu\text{A}$	$V_{CC}/2$	—	—	V
Output lower limit voltage	$V_{L,L1}$	Sink current : 15 mA	—	—	0.7	V
Offset voltage	$V_{OFFL1}$		—	—	15	mV

### ■ Electrical Characteristics at $T_a = 25^\circ\text{C}$

Parameter	Symbol	Conditions	Min	Typ	Max	Unit
L0 amplifier block						
Output upper limit voltage	$V_{H,L0}$	Discharge current : 50 $\mu\text{A}$	3	—	—	V
Output lower limit voltage	$V_{L,L0}$	Sink current : 15 mA	—	—	0.2	V
Offset voltage	$V_{OFFL0}$		—	—	15	mV
COM amplifier block						
Output upper limit voltage	$V_{H,COM}$	Discharge current : 100 mA	$V_{CC}$ -2.5 V	—	—	V
Output lower limit voltage	$V_{L,COM}$	Sink current : 100 mA	—	—	2.5	V
Offset voltage	$V_{OFFCOM}$		—	—	10	mV

#### • Design reference data

Note) The following characteristics are the reference values for design and not guaranteed values.

Parameter	Symbol	Conditions	Min	Typ	Max	Unit
Recovery time	Ri-Time COM		—	—	2	$\mu\text{S}$
REF amplifier block Supply voltage rejection ratio	$\text{PSRR}_{\text{REF}}$	f = 10 kHz to 500 kHz 200 mV[p-p], 0.1 $\mu\text{F}$ connection	—	—	-40	dB
R0 amplifier block Supply voltage rejection ratio	$\text{PSRR}_{\text{R0}}$	f = 10 kHz to 500 kHz 200 mV[p-p], 0.01 $\mu\text{F}$ connection	—	—	-10	dB
R1 amplifier block Supply voltage rejection ratio	$\text{PSRR}_{\text{R1}}$	f = 10 kHz to 500 kHz 200 mV[p-p], 0.01 $\mu\text{F}$ connection	—	—	-20	dB
R2/R3R/4 amplifier block Supply voltage rejection ratio	$\text{PSRR}_{\text{R234}}$	f = 10 kHz to 500 kHz 200 mV[p-p], 0.01 $\mu\text{F}$ connection	—	—	-40	dB
R2/R3R/4 amplifier block Supply voltage rejection ratio	$\text{PSRR}_{\text{L234}}$	f = 10 kHz to 500 kHz 200 mV[p-p], 0.01 $\mu\text{F}$ connection	—	—	-40	dB
L1 amplifier block Supply voltage rejection ratio	$\text{PSRR}_{\text{L1}}$	f = 10 kHz to 500 kHz 200 mV[p-p], 0.01 $\mu\text{F}$ connection	—	—	-10	dB
L0 amplifier block Supply voltage rejection ratio	$\text{PSRR}_{\text{L0}}$	f = 10 kHz to 500 kHz 200 mV[p-p], 0.01 $\mu\text{F}$ connection	—	—	-20	dB
COM amplifier block Supply voltage rejection ratio	$\text{PSRR}_{\text{COM}}$	f = 10 kHz to 500 kHz 200 mV[p-p], 0.1 $\mu\text{F}$ connection	—	—	-40	dB

■ Technical Data

● Measurement circuit for gain and phase characteristics

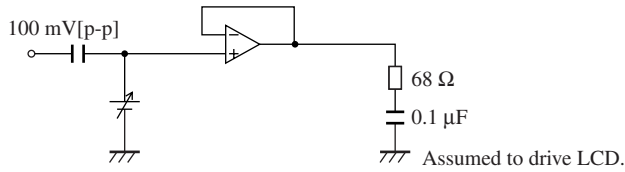

DC voltage

R0 DC = 9.7 V	L4 DC = 4.34 V
R1 DC = 9.01 V	L3 DC = 3.23 V
R2 DC = 7.81 V	L2 DC = 2.32 V
R3 DC = 7.12 V	L1 DC = 980 mV
R4 DC = 6.3 V	L0 DC = 210 mV

● Main characteristics

Power supply current — temperature characteristics  
( $I_{CC} - T_a$ )

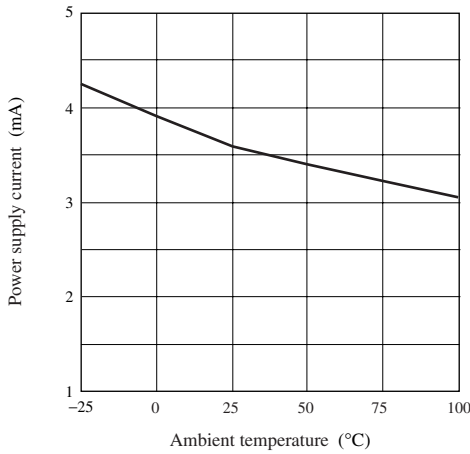

Reference voltage — temperature characteristics  
( $V_{REF} - T_a$ )

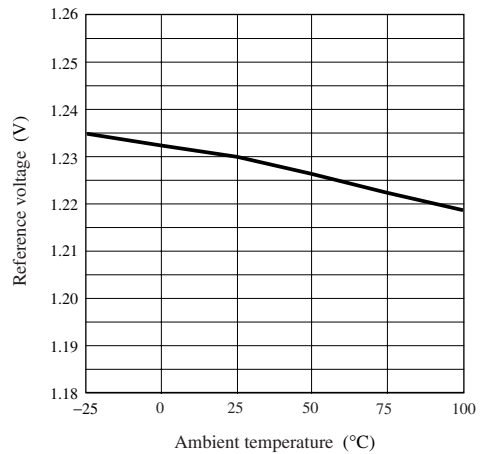

R0 amp. Gain, Phase — Frequency

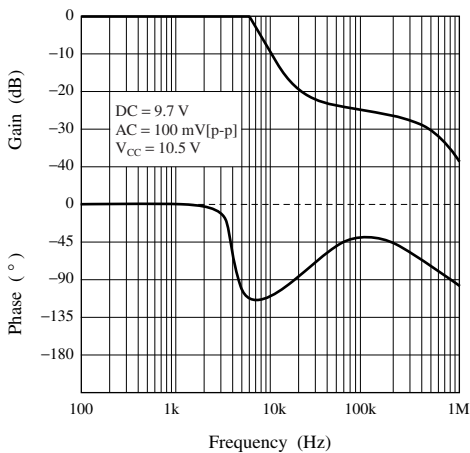

R1 amp. Gain, Phase — Frequency

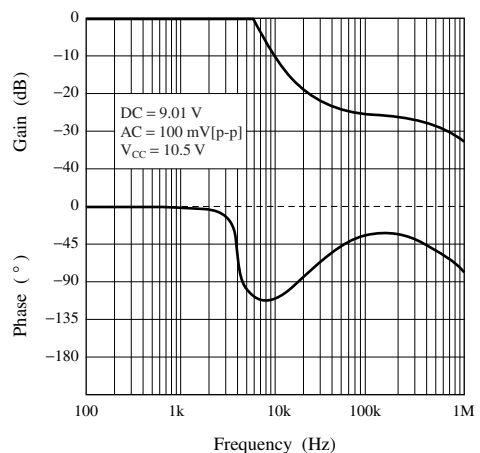

■ Technical Data (continued)

• Main characteristics (continued)

R2 amp. Gain, Phase — Frequency

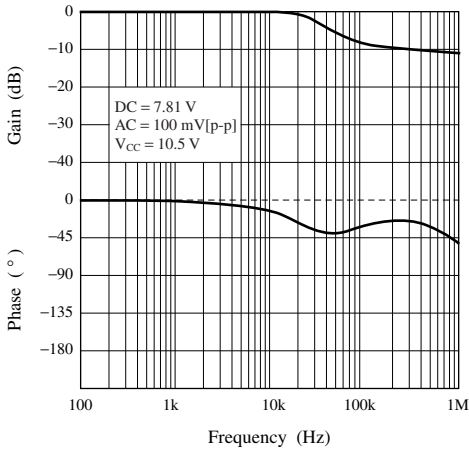

R3 amp. Gain, Phase — Frequency

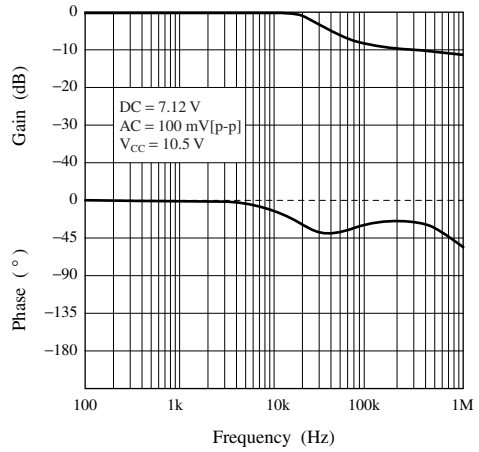

R4 amp. Gain, Phase — Frequency

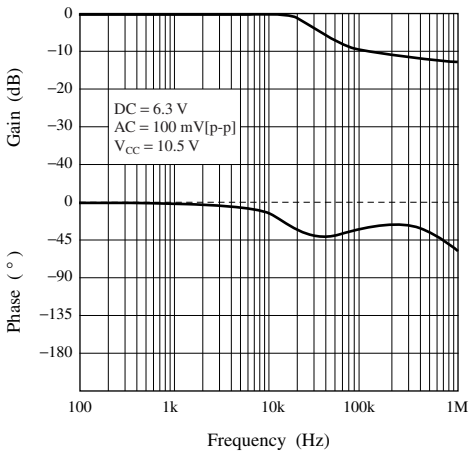

L4 amp. Gain, Phase — Frequency

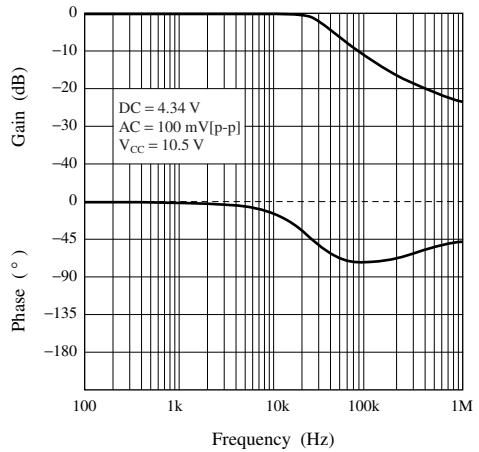

L3 amp. Gain, Phase — Frequency

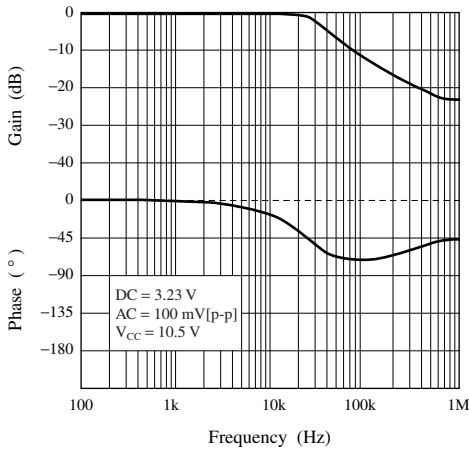

L2 amp. Gain, Phase — Frequency

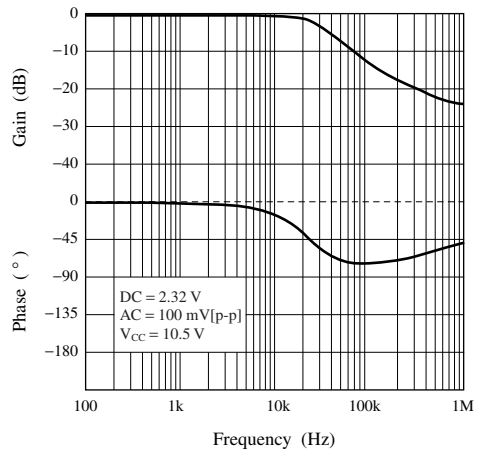

■ Technical Data (continued)

• Main characteristics (continued)

L1 amp. Gain, Phase — Frequency

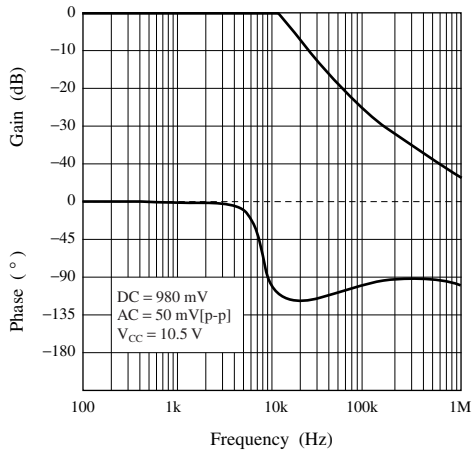

L0 amp. Gain, Phase — Frequency

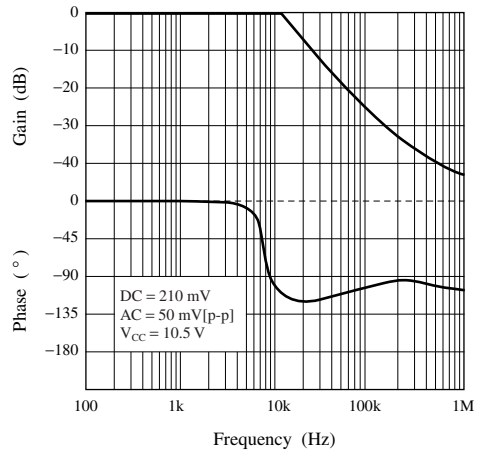

■ Application Circuit Example

• System configuration example

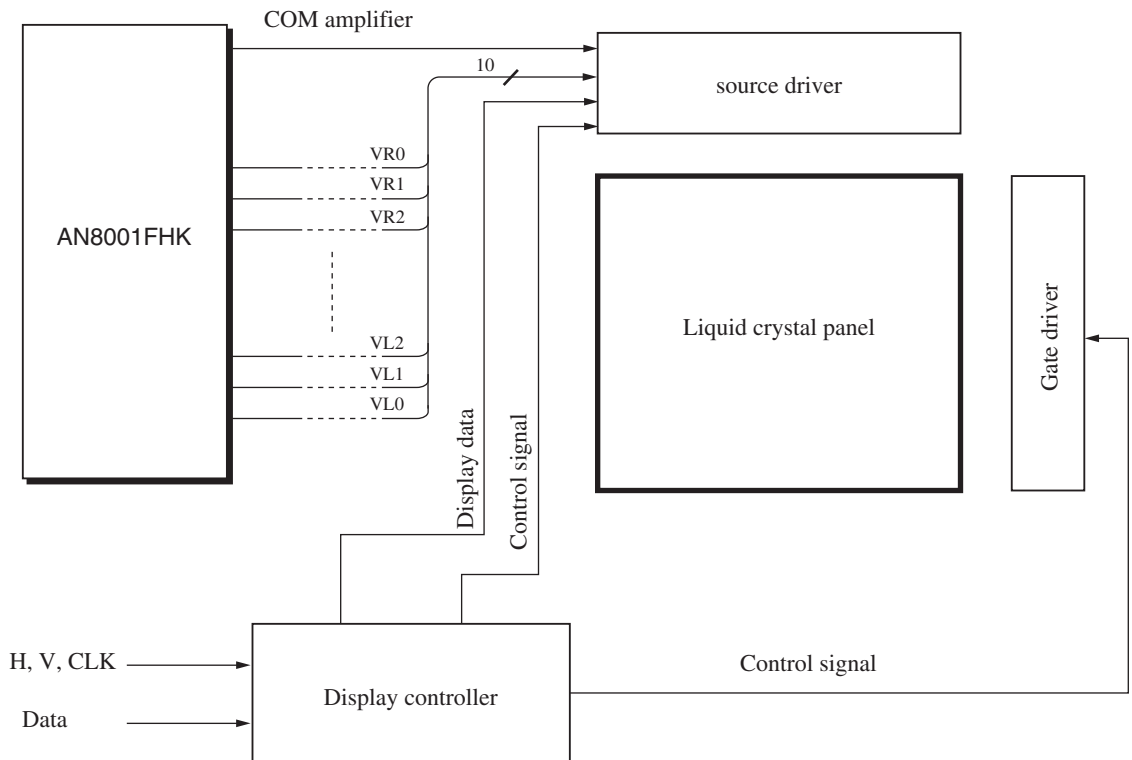

■ Application Circuit Example (continued)

- Application circuit example

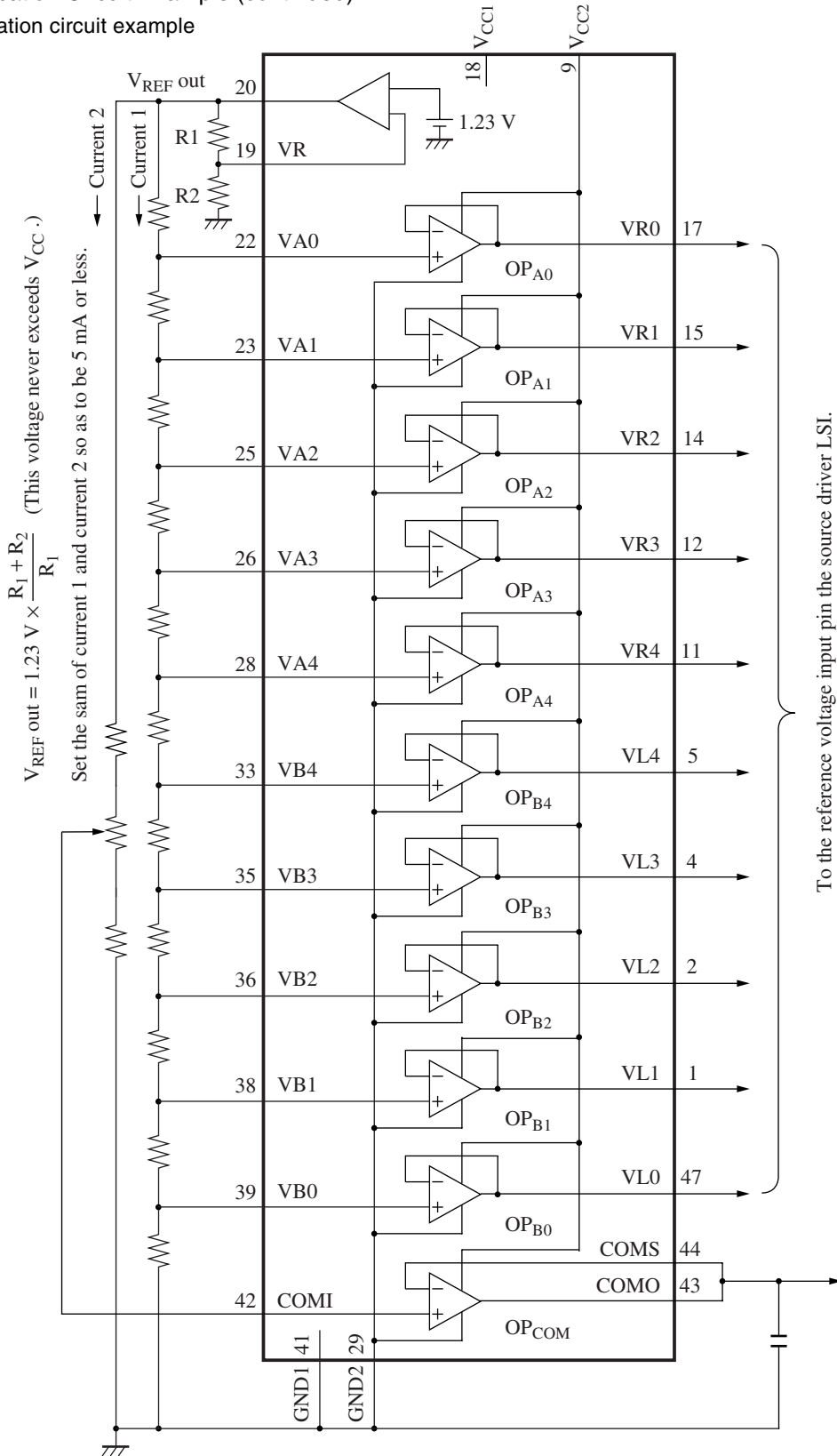

## ■ Application Circuit Example (continued)

&lt;Recommended operating conditions&gt;

Parameter	Symbol	Ratings	Unit	Notes
Supply voltage	$V_{CC}$	10.5	V	
Load capacitance	$C_{LOAD}$	0.01	$\mu\text{F}$	VR0 to VL0
		0.1 to 1	$\mu\text{F}$	COM0
		0.1	$\mu\text{F}$	$V_{REF}$

## Request for your special attention and precautions in using the technical information and semiconductors described in this material

- (1) An export permit needs to be obtained from the competent authorities of the Japanese Government if any of the products or technologies described in this material and controlled under the "Foreign Exchange and Foreign Trade Law" is to be exported or taken out of Japan.
- (2) The technical information described in this material is limited to showing representative characteristics and applied circuit examples of the products. It does not constitute the warranting of industrial property, the granting of relative rights, or the granting of any license.
- (3) The products described in this material are intended to be used for standard applications or general electronic equipment (such as office equipment, communications equipment, measuring instruments and household appliances).  
Consult our sales staff in advance for information on the following applications:
  - Special applications (such as for airplanes, aerospace, automobiles, traffic control equipment, combustion equipment, life support systems and safety devices) in which exceptional quality and reliability are required, or if the failure or malfunction of the products may directly jeopardize life or harm the human body.
  - Any applications other than the standard applications intended.
- (4) The products and product specifications described in this material are subject to change without notice for reasons of modification and/or improvement. At the final stage of your design, purchasing, or use of the products, therefore, ask for the most up-to-date Product Standards in advance to make sure that the latest specifications satisfy your requirements.
- (5) When designing your equipment, comply with the guaranteed values, in particular those of maximum rating, the range of operating power supply voltage and heat radiation characteristics. Otherwise, we will not be liable for any defect which may arise later in your equipment.  
Even when the products are used within the guaranteed values, redundant design is recommended, so that such equipment may not violate relevant laws or regulations because of the function of our products.
- (6) When using products for which dry packing is required, observe the conditions (including shelf life and after-unpacking standby time) agreed upon when specification sheets are individually exchanged.
- (7) No part of this material may be reprinted or reproduced by any means without written permission from our company.

## Please read the following notes before using the datasheets

- A. These materials are intended as a reference to assist customers with the selection of Panasonic semiconductor products best suited to their applications.  
Due to modification or other reasons, any information contained in this material, such as available product types, technical data, and so on, is subject to change without notice.  
Customers are advised to contact our semiconductor sales office and obtain the latest information before starting precise technical research and/or purchasing activities.
- B. Panasonic is endeavoring to continually improve the quality and reliability of these materials but there is always the possibility that further rectifications will be required in the future. Therefore, Panasonic will not assume any liability for any damages arising from any errors etc. that may appear in this material.
- C. These materials are solely intended for a customer's individual use.  
Therefore, without the prior written approval of Panasonic, any other use such as reproducing, selling, or distributing this material to a third party, via the Internet or in any other way, is prohibited.



LittleDiode supplies new, hard to find or obsolete electronic components and semiconductors all over the world.

With over two million different components listed you are sure to find the part you need.

Feel free to visit us today at our online store:

[LittleDiode.com](http://LittleDiode.com)

Looking forward to providing you with the best possible service.