

AN7367K

dbx II Noise Reduction IC for Cassette Deck

■ Overview

The AN7367K is an integrated circuit available for stereo operation on a single chip developed for dbx II type noise reduction, which can also use for U.S. sound multiplex TV. And it is designed for easy use of reference signal level, supply voltage and logic input level.

■ Features

- Dynamic range : 110dB
- 2-channel
- Reference input-output signal level : 90mV
- 2 power supply type (+, -)

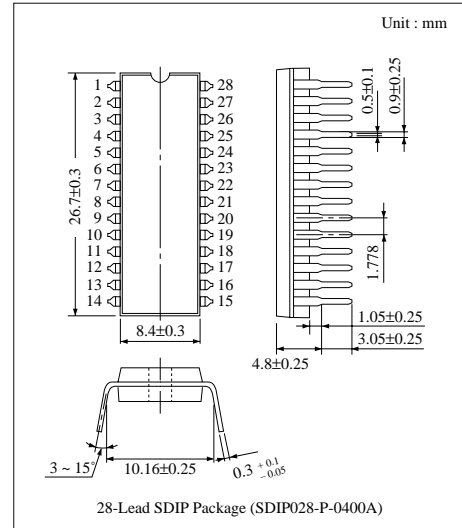

■ Block Diagram

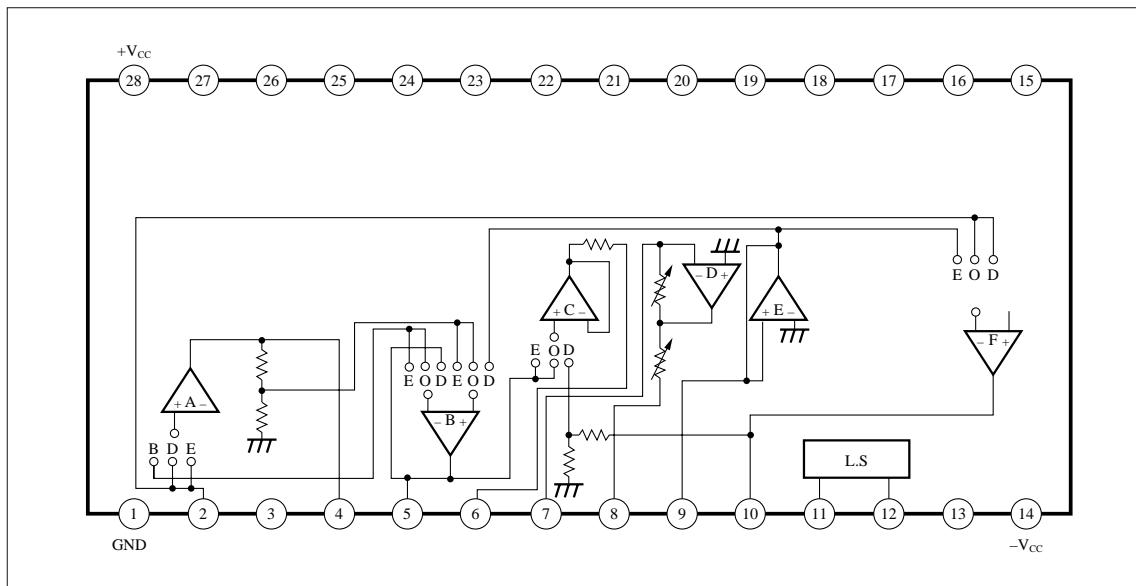

■ Absolute Maximum Ratings (Ta=25°C)

Parameter	Symbol	Rating	Unit
Supply Voltage	V _{CC}	±7.2	V
Supply Current	I _{CC}	30	mA
Power Dissipation (Ta=75°C)	P _D	450	mW
Operating Ambient Temperature	T _{opr}	-20 ~ + 75	°C
Storage Temperature	T _{stg}	-55 ~ + 150	°C

■ Recommended Operating Range (Ta=25°C)

Parameter	Symbol	Range
Operating Supply Voltage Range	V _{CC}	± 5V ~ ±7V

■ Electrical Characteristics (V_{CC}= ± 6V, Ta=25°C)

Parameter	Symbol	Condition	min.	typ.	max.	Unit
Encode Output Voltage	V _{OE}	V _{in} = 1kHz, 90mV (Reference Level)	67.5	85	107	mV
Encode Linearity -1 *1	L _{E-1}	V _{in} = 1kHz, 900mV (Encode)	8	10	12	dB
Encode Linearity -2 *1	L _{E-2}	V _{in} = 1kHz, 0.9mV (Encode)	- 22	- 20	- 18	dB
Decode Output Voltage	V _{OD}	V _{in} = 1kHz, 90mV (Reference Level)	67.5	85	107	mV
Decode Linearity -1 *2	L _{D-1}	V _{in} = 1kHz, 285mV (Decode)	17	20	23	dB
Decode Linearity -2 *2	L _{D-2}	V _{in} = 1kHz, 9mV (Decode)	- 43	- 40	- 37	dB
Encode Max. Output Voltage	V _{OME}	THD= 3%, f= 1kHz	300	—	—	mV
Decode Max. Output Voltage	V _{OMD}	THD= 3%, f= 1kHz	1100	—	—	mV
Encode Total Harmonic Distortion	THD _E	At Encode, 400Hz ~ 30kHz, f= 1kHz, 90mV	—	0.35	0.45	%
Decode Total Harmonic Distortion	THD _D	At Decode, 400Hz ~ 30kHz, f= 1kHz, 90mV	—	0.1	0.3	%
Encode Noise Output Voltage	V _{NOE}	Input short, DIN/AUDIO	—	- 62	- 58	dBV
Decode Noise Output Voltage	V _{NOD}	Input short, DIN/AUDIO	—	- 96	- 92	dBV
Encode Output Difference between Channels	CD _E	V _{in} = 1kHz, 90mV	- 1.3	0	1.3	dB
Decode Output Difference between Channels	CD _D	V _{in} = 1kHz, 90mV	- 2	0	2	dB
Encode Crosstalk between Channels	CT _E	At Encode *3, V _{in} = 1kHz, 900mV	—	- 52	- 45	dBV
Decode Crosstalk between Channels	CT _D	At Decode, V _{in} = 1kHz, 90mV	—	- 91	- 85	dBV
Monitor Output Voltage	V _{OM}	At Encode, V _{in} = 1kHz, 90mV	75	90	107	mV
Monitor Output Voltage Output Difference Between Channels	CD _M	At Encode, V _{in} = 1kHz, 90mV	- 1.5	0	1.5	dB
Monitor Output Noise Output Voltage	V _{NOM}	Encode input, Short DIN/AUDIO	—	- 110	- 106	dBV
Monitor Output Total Harmonic Distortion	THD _M	At Encode, V _{in} = 1kHz, 90mV	—	0.01	0.1	%
dbx OFF Line Output Voltage	V _{LOFF}	V _{in} = 1kHz, 180mV	151	180	214	mV
dbx OFF Rec. Output Voltage	V _{ROFF}	V _{in} = 1kHz, 180mV	151	180	214	mV
dbx OFF line Output Total Harmonic Distortion	THD _{LOFF}	V _{in} = 1kHz, 180mV	—	0.01	0.1	%
dbx OFF Rec Output Total Harmonic Distortion	THD _{ROFF}	V _{in} = 1kHz, 180mV	—	0.01	0.1	%
dbx OFF Line Output Noise Output Voltage	V _{NLOFF}	Input Short, DIN/AUDIO	—	- 110	- 104	dBV
dbx OFF Rec. Output Noise Output Voltage	V _{NROFF}	Input Short, DIN/AUDIO	—	- 110	104	dBV
dbx OFF Line Output Output Difference between Channels	CD _{LOFF}	V _{in} = 1kHz, 180mV	- 1.5	0	1.5	dB
dbx OFF Rec. Output Output Difference between Channels	CD _{ROFF}	V _{in} = 1kHz, 180mV	- 1.5	0	1.5	dB
Input Impedance	Z _{IN}	V _{in} = 1kHz, 90mV	500	—	—	kΩ
Total Circuit Current	I _{tot}	Input Short at Encode	—	12	16	mA

*1 Level Ratio to V_{OE}

*2 Level Ratio to V_{OD}

*3 Measure output leak by short of measuring channel input and input to reverse channel.

■ Electrical Characteristics (Cont.) ($V_{CC} = \pm 6V$, $T_a = 25^\circ C$)

Parameter	Symbol	Condition	min.	typ.	max.	Unit
dbx ON/OFF Control dbx ON	V_{15ON}	Satisfy specifications of the preceding page $V_{OE} \sim V_{NLOFF}$	3.2	—	6	V
dbx ON/OFF Control dbxOFF	V_{15OFF}	Satisfy specifications of the preceding page $V_{OE} \sim V_{NLOFF}$	$-V_{EE}$ $+ 0.4V$	—	1.8	V
Encode/Decode Control Encode	V_{16EN}	Satisfy specifications of the preceding page $V_{OE} \sim V_{NLOFF}$	3.2	—	6	V
Encode/Decode Control Decode	V_{16DE}	Satisfy specifications of the preceding page $V_{OE} \sim V_{NLOFF}$	$-V_{EE}$ $+ 0.4V$	—	1.8	V
dbx ON/OFF Control "L" Overflow Current	I_{15L}	$V_{15} = 1.8V$	-2.1	—	-0.2	μA
Encode/Decode Control "L" Overflow Current	I_{16L}	$V_{16} = 1.8V$	-2.1	—	-0.2	μA
Pulse Noise at Encode	V_{NPE}	Input Short, Time : a second, number : one	—	—	13	mVP-P



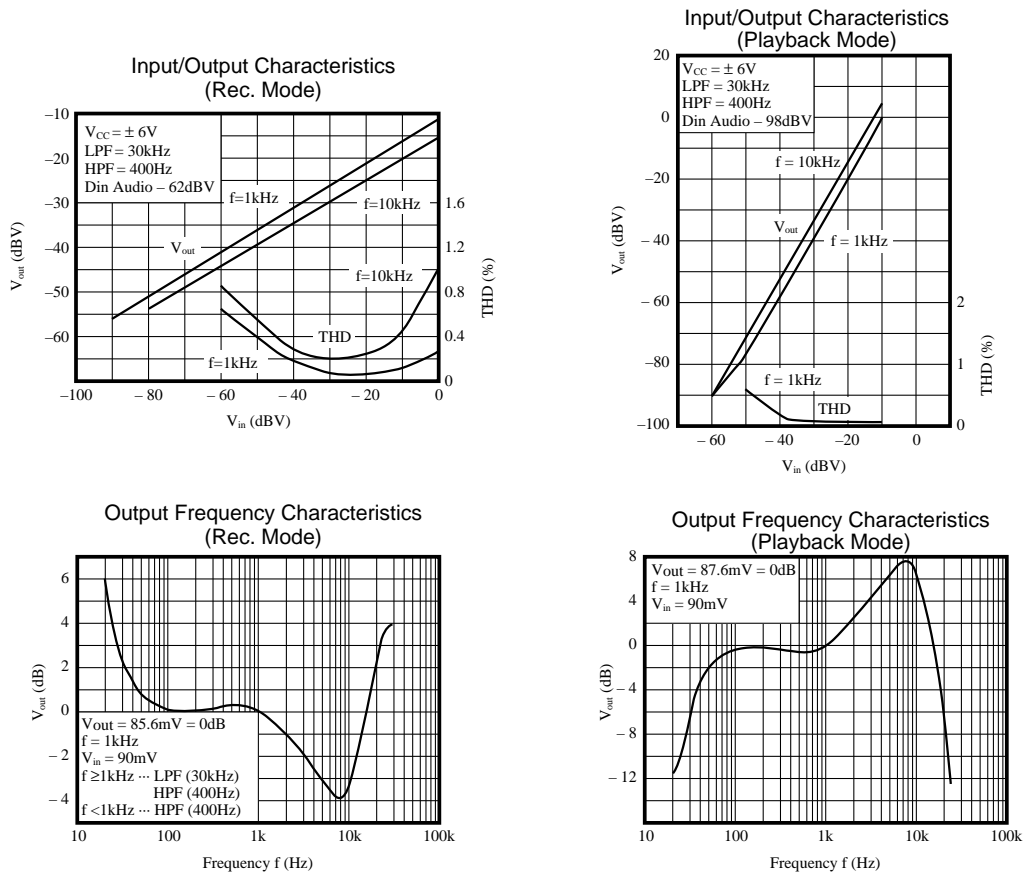





■ Characteristics Curve

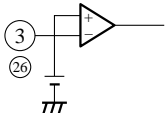
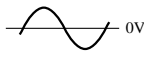
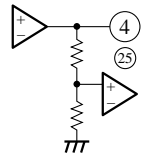
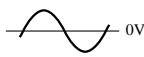
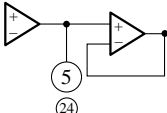

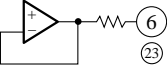
■ Pin Description

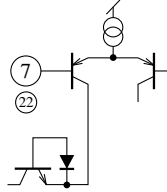
Pin No.	Pin Name	Typ. Waveform	Description	Equivalent Circuit
2 27	Recording Signal Input		Pin for inputting signal	

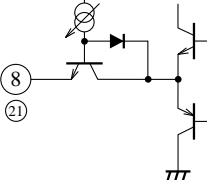
■ Pin Description (Cont.)

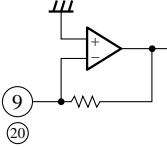
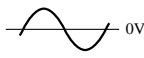
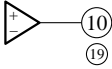
Pin No.	Pin Name	Typ. Waveform	Description	Equivalent Circuit
3 · 26	Emphasis		Emphasis amp. – side input pin	
4 · 25	Line Amp. Output		Line amp. output pin	
5 · 24	Emphasis Amp. Output		Emphasis amp. output pin	
6 · 23	Buffer Output		Buffer output pin	
7 · 22	CCA Input		CCA input pin	
8 · 21	CCA Output		CCA output pin	
9 · 20	CCA Amp. Input		CCA amp. input pin	
10 · 19	Rec. Out Output		Rec. out output pin	

■ Pin Description (Cont.)

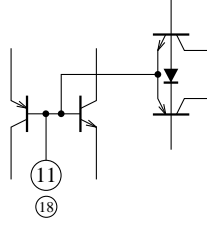
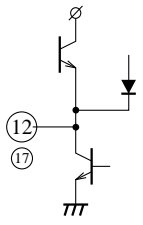
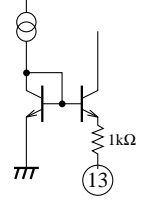
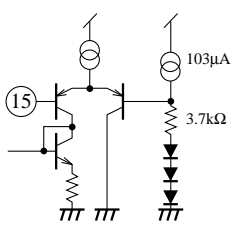
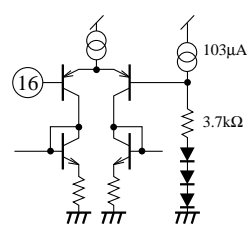
Pin No.	Pin Name	Typ. Waveform	Description	Equivalent Circuit
11 · 18	Level Sensor Input	-5.2V	Level sensor input pin	
12 · 17	Timing Capacitor	-5.3V	Level sensor smoothing pin	
13	Timing Current Adjusting Pin	_____	Adjust the timing current by external variable resistance.	
15	dbx ON/OFF Switching	_____	High- dbx ON Low- dbx OFF	
16	Encode/ Decode Switching	_____	High - Encode Low- Decode	
1	GND	_____	_____	_____
14	(-) Power Supply	_____	_____	_____
28	(+) Power Supply	_____	_____	_____

■ Precautions on Use

- 1) For the emphasis, RMS filter, and waiting C, R, use those resistors and capacitors which satisfy the following error ranges. (R ; $\pm 2\%$, C ; $\pm 5\%$)
- 2) For the timing capacitor, use a suitable one whose error is within $\pm 5\%$ and whose $\tan \delta$ is small enough. The selected timing capacitor must also has excellent temperature characteristics.
- 3) Adjust the timing adjustment pin so that the level on both $1k\Omega$ ends becomes 18.4mV.
- 4) If shortening of the power ON rise time is necessary, connect the timing capacitor as shown in the sketch below.

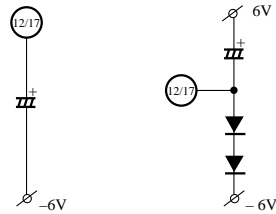

Note) Remember to make the power impedance low enough.

- 5) Encode THD

The product specification is based on the data confirmed by use of a band-pass filter (400Hz ~ 30kHz).

The distortion rate in the secondary to quintic higher harmonics measured by a spectrum analyzer is about 0.16%.

- 6) When users use the AN7367K, contract should be made between the dbx Technology Licensing. dbx license and trademark should be contacted with the following.

the U.S.A. : dbx Technology Licensing
 433 California Street, Third Floor
 San Francisco, California 94104
 Tel : 415-765-2801
 Fax : 415-765-2141

Japan Office : dbx Technology Licensing
 Tel : 03-3378-0915
 Fax : 03-3374-5191

Request for your special attention and precautions in using the technical information and semiconductors described in this material

- (1) An export permit needs to be obtained from the competent authorities of the Japanese Government if any of the products or technologies described in this material and controlled under the "Foreign Exchange and Foreign Trade Law" is to be exported or taken out of Japan.
- (2) The technical information described in this material is limited to showing representative characteristics and applied circuit examples of the products. It does not constitute the warranting of industrial property, the granting of relative rights, or the granting of any license.
- (3) The products described in this material are intended to be used for standard applications or general electronic equipment (such as office equipment, communications equipment, measuring instruments and household appliances).
Consult our sales staff in advance for information on the following applications:
 - Special applications (such as for airplanes, aerospace, automobiles, traffic control equipment, combustion equipment, life support systems and safety devices) in which exceptional quality and reliability are required, or if the failure or malfunction of the products may directly jeopardize life or harm the human body.
 - Any applications other than the standard applications intended.
- (4) The products and product specifications described in this material are subject to change without notice for reasons of modification and/or improvement. At the final stage of your design, purchasing, or use of the products, therefore, ask for the most up-to-date Product Standards in advance to make sure that the latest specifications satisfy your requirements.
- (5) When designing your equipment, comply with the guaranteed values, in particular those of maximum rating, the range of operating power supply voltage and heat radiation characteristics. Otherwise, we will not be liable for any defect which may arise later in your equipment.
Even when the products are used within the guaranteed values, redundant design is recommended, so that such equipment may not violate relevant laws or regulations because of the function of our products.
- (6) When using products for which dry packing is required, observe the conditions (including shelf life and after-unpacking standby time) agreed upon when specification sheets are individually exchanged.
- (7) No part of this material may be reprinted or reproduced by any means without written permission from our company.

Please read the following notes before using the datasheets

- A. These materials are intended as a reference to assist customers with the selection of Panasonic semiconductor products best suited to their applications.
Due to modification or other reasons, any information contained in this material, such as available product types, technical data, and so on, is subject to change without notice.
Customers are advised to contact our semiconductor sales office and obtain the latest information before starting precise technical research and/or purchasing activities.
- B. Panasonic is endeavoring to continually improve the quality and reliability of these materials but there is always the possibility that further rectifications will be required in the future. Therefore, Panasonic will not assume any liability for any damages arising from any errors etc. that may appear in this material.
- C. These materials are solely intended for a customer's individual use.
Therefore, without the prior written approval of Panasonic, any other use such as reproducing, selling, or distributing this material to a third party, via the Internet or in any other way, is prohibited.



LittleDiode supplies new, hard to find or obsolete electronic components and semiconductors all over the world.

With over two million different components listed you are sure to find the part you need.

Feel free to visit us today at our online store:

LittleDiode.com

Looking forward to providing you with the best possible service.