

AN6425K

Speech Network Circuit

Overview

The AN6425K is a high-function speech network IC with speaker amplifier. It incorporates a transmitter-system non-linear circuit, receiver digital VRs, etc. and is suitable for realizing the multifunctional telephone sets.

Features

- Speech network IC for the multifunctional telephone sets
- Capable of interfacing with the light-weight small receivers and ECM transmitters
- Built-in 2V REG constant voltage source (2V typ) for ECM
- Built-in non-linear circuits in the transmitter and receiver systems in order to eliminate ambient noises
- Built-in speaker amplifier and capable of driving with a main wire current
- Built-in hold-tone amplifier, key-in-tone amplifier, and DTMF transmitter, and capable of setting the mode with the control pins
- Automatic gain control (automatic pad function) according to a circuit current
- Built-in tertiary active filter circuit and capable of sending a DTMF circuit with much higher harmonic at a low distortion factor
- Built-in single touch receiver volume-up function (about 6dB)

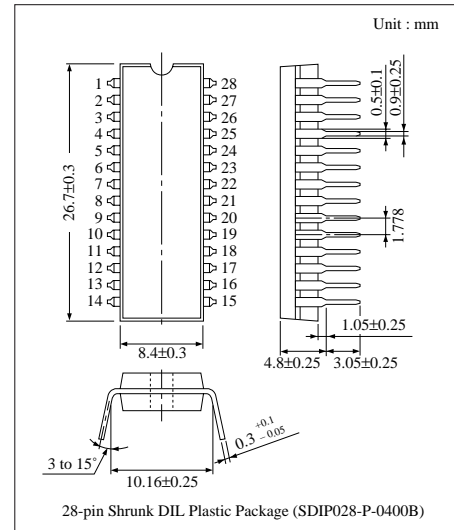

Block Diagram

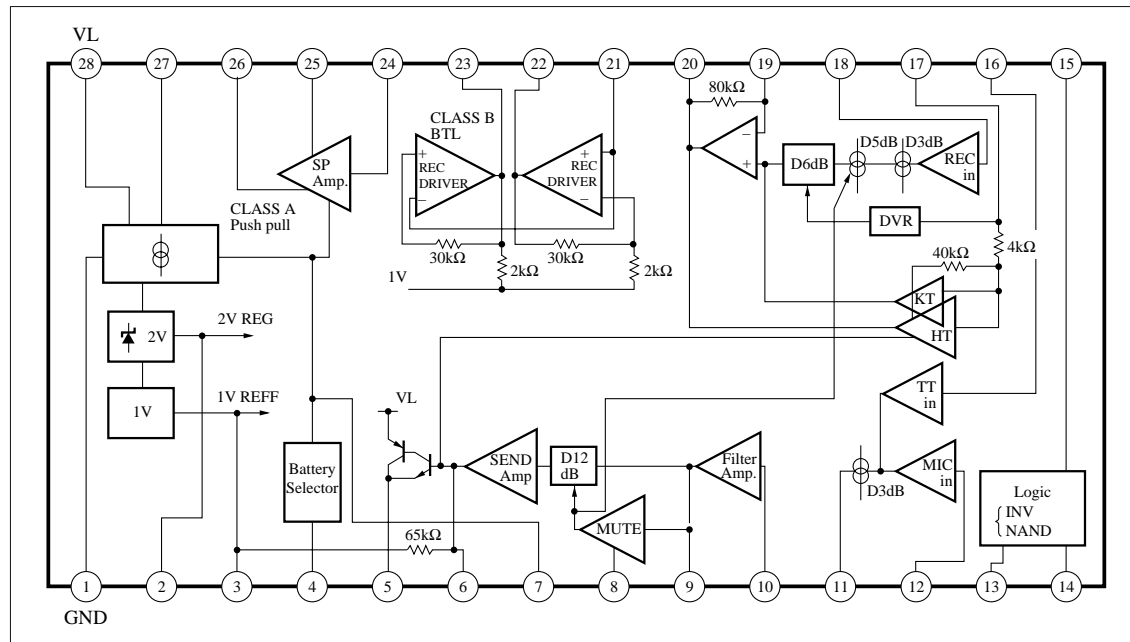

■ Absolute Maximum Ratings (Ta=25°C)

Parameter	Symbol	Rating	Unit
Supply voltage	V _L	14.4 *	V
Supply current	I _L	120 *	mA
Power dissipation	P _D	1200 *	mW
Operating ambient temperature	T _{opr}	-20 to +65	°C
Storage temperature	T _{stg}	-55 to +150	°C

* V_{CC} × I_{CC} < 1200mW

■ Recommended Operating Range (Ta=25°C)

Parameter	Symbol	Range
Operating supply voltage range	V _L	3 to 12V

■ Electrical Characteristics (Ta=25°C)

Parameter	Symbol	Condition	min	typ	max	Unit
Receiver gain	G _V (REC)	Open between the Pins19 and 20. Measure the output between the Pins22 and 23 when a signal (-55dBm) is input to the Pin18.	48	50.5	53	dB
Receiver distortion factor	THD (REC)	Open between the Pins19 and 20. Measure the output distortion factor between the Pins 22 and 23 when a signal (-55dBm) is input to the Pin18.	—	1	5	%
Receiver maximum output voltage	V _O (REC)	Input a signal to the Pin18 and measure the output between the Pins22 and 23 at an output distortion factor of 5%.	0	+3	—	dBm
D Automatic pad	AP (REC)	Input a signal (-45dBm) to the Pin18 and measure an output change between the Pins22 and 23 when I _L changes from 80mA to 30mA.	-6	-3	-1.5	dB
D Receiver noise prevention	MUTE (REC)	Input a signal (-45dBm) to the Pin18 and measure an output change between the Pins 22 and 23 when the Pin12 changes from no microphone input signal to -40dBm.	-7	-5	-3	dB
Receiver D digital VR	DVR	Input a signal (-45dBm) to the Pin18 and measure an output change between the Pins 22 and 23 when the Pin12 is set from H to L.	4	6	8	dB
Receiver noise output	V _{no} (REC)	Measure the output between the Pins22 and 23 when there is no signal at the Pin18.	—	-50	-45	dBm
Transmitter gain	G _V (SEND)	Open between the Pins3 and 6. Measure the output between the Pins28 and 1 when a signal (-45dBm) is input to the Pin12.	40	42.5	45	dB
Transmitter distortion factor	THD (SEND)	Open between the Pins3 and 6. Measure the output distortion factor between the Pins28 and 1 when a signal (-45dBm) is input to the Pin12.	—	1.5	5	%
Transmitter maximum transmission level	V _O (SEND)	Input a signal to the Pin12 and measure the output between the Pins28 and 1 at an output distortion factor of 5%.	2	5	—	dBm
Transmitter D automatic pad	AP (SEND)	Input a signal (-35dBm) to the Pin12 and measure an output change between the Pins 28 and 1 when I _L changes from 80mA.	-6	-3	-1.5	dB
Transmitter noise prevention	V _{no} (SEND)	Measure the output between the Pins28 and 1 when there is no signal at the Pin18.	—	-65	-60	dBm
HOLD TONE gain	G _V (HOLD)	Ground the Pin24. Input a signal (-30dBm) to the Pin17 and measure the output change between the Pins 28 and 1.	23.5	26.5	29.5	dB
TOUCH TONE gain	G _V (TOUCH)	Ground a signal (-45dBm) to the Pin16 and measure the output between the Pins28 and 1.	39	41.5	44	dB
TOUCH TONE distortion factor	THD (TOUCH)	Ground the Pin14. Input a signal (-45dBm) to the Pin16 and measure the output distortion factor between the Pins 28 and 1.	—	1	3	%

* I_L=30mA and Freq=1kHz unless otherwise specified.

■ Electrical Characteristics (cont.) (Ta=25°C)





Parameter	Symbol	Condition	min	typ	max	Unit
TOUCH TONE D automatic pad	AP (TOUCH)	Ground the Pin14. Input a signal (-45 dBm) to the Pin16 and measure an output change between the Pins 28 and 1 when I_L changes from 80mA to 30mA.	-6	-3	-1.5	dB
SP amplifier gain	G_V (SP)	Ground the Pin15. Input a signal (-50dBm) to the Pin24 and measure the output between the Pins 25 and 26.	45	50	—	dB
SP distortion factor	THD (SP)	Ground the Pin15. Input a signal (-50dBm) to the Pin24 and measure the output distortion factor between the Pins 25 and 26.	—	—	10	%

* $I_L=30mA$ and Freq=1kHz unless otherwise specified.

■ Pin Descriptions

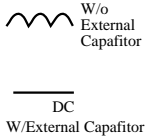
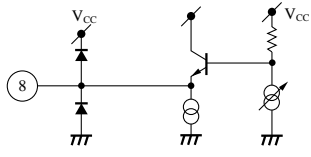
Pin No.	Pin name	Typical waveform	Description	Equivalent circuit
1	GND	— DC 0V	Ground pin. Connect to the output of the diode bridge.	—
2	2V REG	— DC 2V	2V internal stabilized power supply output pin. Connect to GND via 220 μ F. The current obtainable from this pin is 5mA or less (at $I_L=20mA$).	
3	1V REF	— DC 1V	1V reference voltage output pin. Connect to GND via 47 μ F. No current is allowed to be input/output from this pin.	
4	BT	— DC 0 to 6V (Supplied from Outside)	External battery connection pin. Connect the 3 to 6V battery to GND. Connect to GND directly when the BT function is not used.	—
5	SEND OUTPUT		Transmitter output. Transmitter gain control pin. Controls the gain and frequency characteristic of the transmitter system with external C and R.	
6	SEND DRIVER			
7	1/2VL	— DC $\frac{5}{7} \times V_L$	Automatic pad control pin. Capable of controlling the pad operating point with the external resistor.	

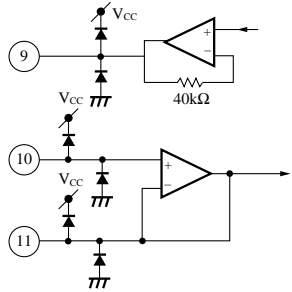

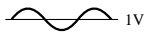
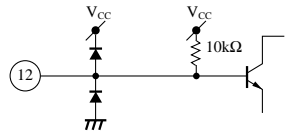
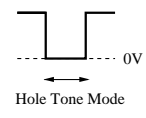
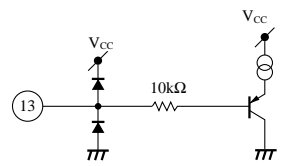
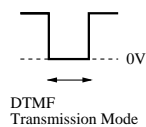
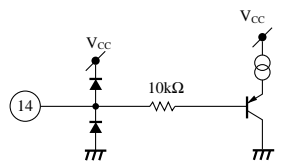
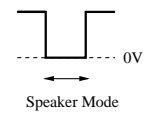
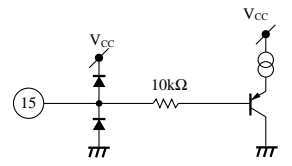
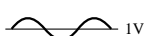
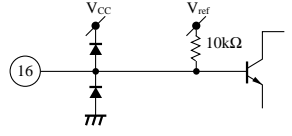
Pin Descriptions (cont.)

Pin No.	Pin name	Typical waveform	Description	Equivalent circuit
8	Mute		Noise precentice peak hold pin. Connect to GND via 10µF.	
9	LPF (1)		Transmitter filter pin. Constitutes the tertiary active filter with the external parts C and R, and capable of controlling the high-pass transmitter frequency characteristic.	
10	LPF (2)			
11	LPF (3)			
12	MIC input		Microphone input pin. Input pin for the microphone.	
13	HC		HOLD TONE control pin. The HOLD TONE transmission mode is set by setting this pin to Low.	
14	DMC		DIAL MUTE control pin. The DTMF transmission mode is set by setting this pin to Low.	
15	SPC		SPEAKER control pin. The speaker mode is set by setting this pin to Low.	
16	TT input		DTMT signal input pin. Inputs a DTMF signal. A signal is sent to the circuit when the Pin14 is at Low.	

Pin Descriptions (cont.)

Pin No.	Pin name	Typical waveform	Description	Equivalent circuit
17	KT/HT input DVR input		<p>KT/HT signal input pin, Digital VR ON Pin. Inputs a KEY IN TONE or HOLD TONE signal. If the Pin14 is set to Low, the KT signal is output to the receiver, and if the Pin13 is set to Low, the HT signal is output to the circuit and speaker. The receiver gain is improved 6dB by setting this pin to Low instantaneously.</p>	
18	REC input		<p>Receiver signal input pin. Inputs a receiver signal from the side tone preventive circuit network.</p>	
19	REC NFB		<p>Receiver gain control pin, Receiver signal output pin. Capable of controlling the frequency characteristic and gain of the receiver system with the external parts C and F of the Pins19 and 20. The receiver signal/HOLD TONE signal/KEY IN TONE signal is output to the Pin20 by the HC/DMC/SPC control.</p>	
20	REC output			
21	Driver input		<p>Receiver amplifier signal input pin, Receiver output (1) pin, Receiver output (2) pin. Inputs a receiver signal from the Pin20 to the Pin21. BTL output at the Pins20 and 23.</p>	
22	Driver output (1)			
23	Driver output (2)			
24	SP input		<p>Speaker amplifier signal input pin. Inputs a receiver signal from the Pin20.</p>	

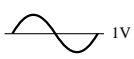
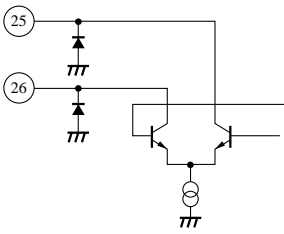
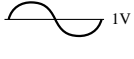
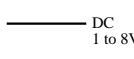
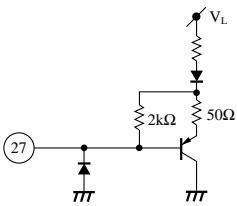
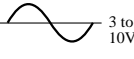
■ Pin Descriptions (cont.)

Pin No.	Pin name	Typical waveform	Description	Equivalent circuit
25	SP out (1)		Speaker output (1) pin. Speaker output (1) pin. Output of the class-A differential amplifier and connected to the speaker through the transformer (300Ω) with intermediate tap.	
26	SP out (2)			
27	BS		Power supply boot strap pin. Connects to the Pin28 via 47μF. The DC resistance of the communication circuit is determined by connecting an external resistor to GND.	
28	V _L		Supply current input pin. Connects to the + output of the diode bridge.	

■ Supplementary Descriptions

• Electrical Characteristics Design Reference Values (Ta=25°C)

Parameter	Symbol	Condition	min	typ	max	Unit
KEY IN TONE gain	G _{V (KEY)}	Measure the output between the Pin22 and 23 when key input (Pin17)=-40dBm.	—	40	—	dB
Δ Transmitter noise preventive attenuation	MUTE (SEND)	To the Pin8 – GND	—	-14	—	dB
Δ Transmitter noise preventive selector level	MUTE (MIC)	REC output Δ -1dB	—	-62	—	dBm
Low impedance drive	R _{L (REC)}	R (REC)=130Ω, Input=-50dBm	—	35	—	dB
DC resistance (1)	R _{DC (1)}	With I _L =20mA, measure the DC voltage at the Pin28 when connecting 6.2kΩ between the Pins27 and 1.	—	3.8	—	V
DC resistance (2)	R _{DC (2)}	With I _L =100mA, measure the DC voltage at the Pin28 when connecting 6.2kΩ between the Pins27 and 1.	—	10	—	V
AC impedance (1)	Z _{AC (1)}	Measure the AC impedance between the Pins28 and 1 at I _L =20mA.	—	2	—	kΩ
AC impedance (2)	Z _{AC (2)}	Measure the AC impedance between the Pins28 and 1 at I _L =100mA.	—	1.5	—	kΩ
Internal regulator voltage	V _{REG}	Measure the DC voltage at the Pin2 at I _L =30mA.	—	2	—	V
Internal reference voltage	V _{REF}	Measure the DC voltage at the Pin3 at I _L =20mA.	—	1	—	V

Note) The above characteristics are design reference values and not guaranteed values.

■ Characteristics Curve

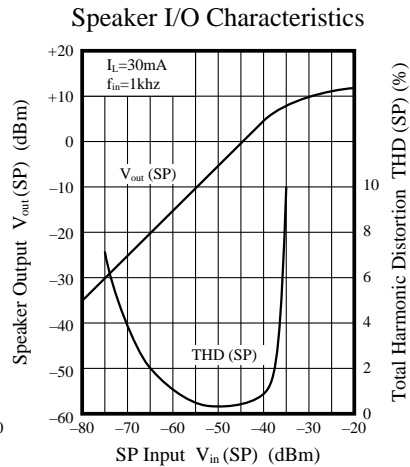
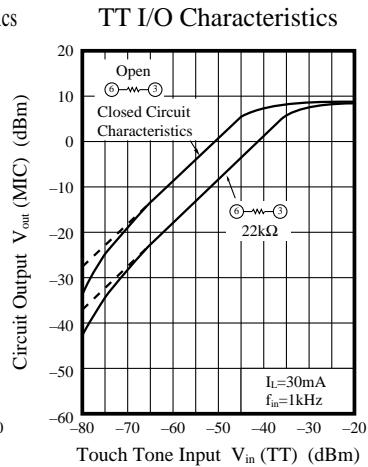
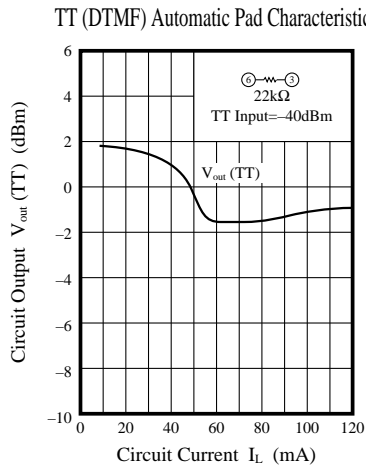
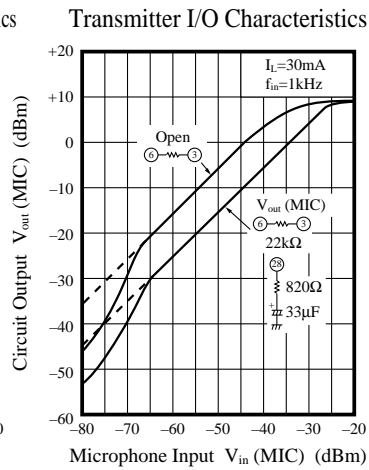
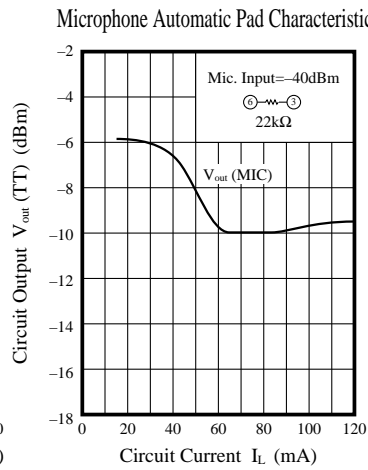
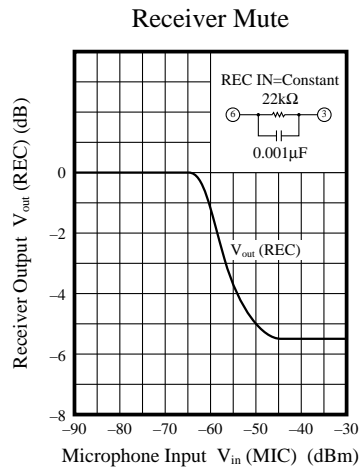
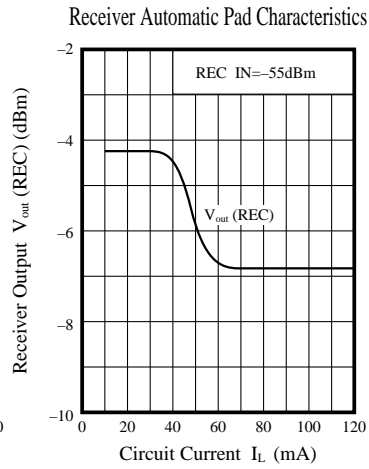
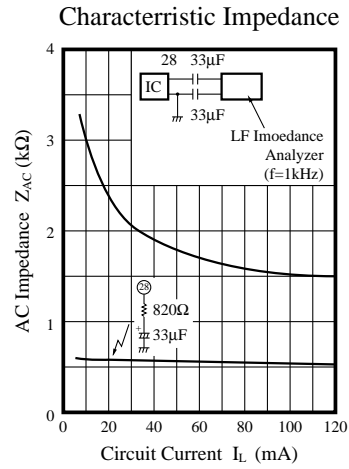
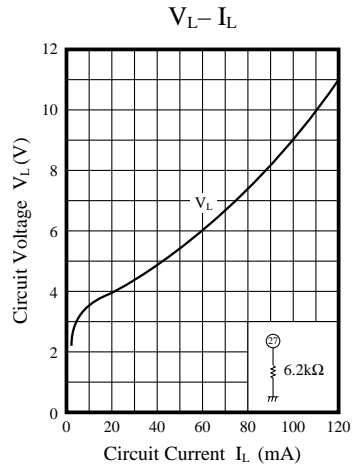



LittleDiode supplies new, hard to find or obsolete electronic components and semiconductors all over the world.

With over two million different components listed you are sure to find the part you need.

Feel free to visit us today at our online store:

LittleDiode.com

Looking forward to providing you with the best possible service.